

Industrial marking systems

2014 Edition

WARNINGS

The characteristics of the products contained in this catalogue are not binding for Cabur and can be changed, without prior notice, due to production requirements or to improve the products. Hence, please contact our technical-commercial network for any necessary confirmations or updates. You can find additional information about this and other Cabur products at our website www.cabur.eu

Introduction

The Company	pg. 4
Documentation	pg. 5
Website	pg. 6
Product Line	pg. 7
Directives and Norms	pg. 8
The EC label	pg. 8

Marking systems

CaburJet System	pg. 10
Inserting cards into the automatic feeder and printing remnants	pg. 11
Inserting single sheet labels	pg. 11
CaburPlot System	pg. 12
MarKing Pro	pg. 14

Products for marking

Tags for wires	pg. 16
Transparent sleeves for tags	pg. 17
Wire-labelling tags for wires with 2.6 - 4.2 mm external diameters	pg. 18
Tags for Cabur terminal blocks	pg. 19
Tags for other terminal blocks	pg. 20
Assembly of stepped tags on terminal blocks	pg. 21
Tags for contactors	pg. 22
Slotted sleeve	pg. 23
Rails for TA 209W/Y	pg. 23
Labels for modular contactor equipment and switches	pg. 23
Adhesive tags distribution boards	pg. 24
Rigid adhesive tags	pg. 25
Tags for tag holders and rails	pg. 25
Protective clear covers for tags	pg. 26
Tag holders	pg. 26
Adhesive tag holders	pg. 27
Slotted sleeves for tags	pg. 27
Tag holders for identification of groups of terminal blocks	pg. 28
Strips for rails and adhesive strips	pg. 28
Rails	pg. 29
Panel identification tags	pg. 29
	pg. 30

Manual numbering

Manual numbering for wire identification	
Transparent sleeves	pg. 32
Accessories for manual numbering	pg. 33
Shaped rings	pg. 33
Linked rings	pg. 34
Manual numbering for Cabur CSC Series terminal blocks.....	pg. 35
Identification tag	pg. 36
Pens for CB/CTL writing	pg. 37
	pg. 37

Wiring accessories

Closed end slices	
Wire terminals, pre-insulated with PVC	pg. 40
Crimper	pg. 41
Screwdrivers	pg. 43
Insulated screwdrivers for voltages of up to 1,000 V	pg. 44
Braided sheath	pg. 44
Heat-shrink sleeve	pg. 45
	pg. 47

Pre-printed tags and accessory services

Speed Rail	
Pre-printed tags for Cabur terminal blocks	pg. 52
Pre-printed tags for Cabur spring-clamp terminal blocks	pg. 54
Personalised printing service	pg. 56
	pg. 57

Code index

	pg. 60
--	--------

The company

Founded in 1952, Cabur quickly gained the lead position among national constructors of terminal blocks for electrical panels, pursuing a policy which focused particularly on installers' needs and proposing cutting edge technological solutions, which in time became generalised applications. Above all, it was ahead of its time in the qualitative choices for its products, especially regarding raw materials, as well as guaranteed functioning, reliability over time and respect for the environment.

Thanks to all this, in 1985 Cabur obtained Class 1E Qualification (Equipment for Nuclear Power Generating Stations) and ISO 9001 (Quality) and ISO 14001 (Environment) Certifications, as well as certified conformity to the ATEX Directive for installations "Ex e" on main terminal block lines.

The quality of Cabur's products and services has been recognised over the years by innumerable certifying bodies recognised at an international level.

In 2006 Cabur acquired a new advanced production site, which stretches over an area of 15,000 m² in the municipality of Altare (Savona). The extra surface space and a simultaneous increase in personnel allowed the production process to be rationalised and rendered even more efficient, as well as improving logistics and sales activities.

Present production, which is wide-ranging and diversified, represents the optimal synthesis of Cabur's long experience as a supplier to the main national energy organisations and companies, together with activities and collaboration abroad.

Cabur develops and produces, on its own design, a very wide range of products for the electro-technical and electronic industries, famous for their reliability even in extreme working conditions, and created to give optimal answers to users' various, complex installation needs.



Documentation:

- **Systems and products for the connection of electrical panels**

terminal blocks and boards for electrical panels, polyamide terminal blocks with screw clamps and spring clamps, in melamine, control rail assemblies, power rail assemblies, mobile rail assemblies, protected distribution terminal boards, 12-pole polyamide rail assemblies.

- **Electronic products for electrical panels**

power supplies, analogue modules, relay modules, signal converters.

- **Connection systems for photovoltaic systems**

connectors, tools, wires, connection systems for photovoltaic equipment, string boxes, surge protection devices, blocking diodes, fuse boxes.

- **Industrial marking systems**

plotters and printing systems, tags and accessories for identification of wires and terminal blocks, tags for contactors and push-buttons, modular strips for electrical distribution boards, and panel identification tags.



If you want to receive complete up to date technical documentation for Cabur products, send us a request using the special on-line form at the website www.cabur.eu

<http://www.cabur.eu/documentations>

or fill out and send the form

I WANT TO RECEIVE COMPLETE TECHNICAL DOCUMENTATION

Last Name Name Role

Company Name Sector: Distributor Installation Control Panel Maker Other

Address City Postal Code

Telephone Fax E-mail

The data provided will be stored and used by Cabur srl in both paper and electronic form, both directly and through a reliable service provider, safely and with attention to privacy. At any time, you may exercise your rights pursuant to Italian Legislative Decree no. 196/2003, by writing to the data manager at the following address: Cabur srl, with offices in Altare (SV), Località Isola Grande 45 - Italy.

I authorise usage of my data in accordance with Italian Legislative Decree 196/2003, as amended, for:

- The provision of goods and services (necessary to send documentation) YES NO
- Statistical profiles and processing YES NO
- Sending commercial communications YES NO
- Communication of data to agencies and partner companies YES NO

Signature authorising data use

Date

**PLEASE COPY AND SEND
TO THIS NUMBER
+39 019 58 999 280**

The website www.cabur.eu

Thanks to its website, Cabur offers its customers and other operators in the sector the possibility to keep up to date about all the new products and commercial offers.

Data sheets for all Cabur products, including those in this catalogue, are available in electronic format in the on-line catalogue, and can be accessed through the index or the advanced search engine.

In addition, on the website you can:

- consult with our specialised personnel to receive information or suggestions about our products
- contact our sales staff and request an estimate
- download manuals and other technical documents
- access quality and conformance certificates
- consult the most recent commercial documentation
- request a free catalogue or brochure
- much more.

Through its newsletter, Cabur also communicates the latest news and sales offers to all those who have registered to receive communication via e-mail.

The website www.cabur.eu is the perfect way to obtain information and communicate with the company in real time.



www.cabur.eu

All the information about the Company, its products, and its certifications in real time.

To keep up to date in real time about the availability of new technical and commercial documentation, register on our site and sign up for our newsletter.

Product line

With 60 years of experience, Cabur develops and creates, based on its own designs, a vast array of products for the electro-technical and electronic industries that are famous for their reliability even under extreme conditions.

Our current production includes:

- **terminal blocks and boards for electrical panels**
- **electronic products for electrical panels**
- **terminal blocks for civil and industrial installations**
- **products for photovoltaic systems**
- **industrial marking systems**

which perfectly meet the various and complex installation needs of users. Our production, which is wide and diversified, represents the optimal synthesis of Cabur's long experience as a supplier to the main national energy boards and companies, together with activities and collaboration abroad.

It should be noted that due to a careful design decision, our products are not designed for use only in specific environments but rather our "normal" products are designed to meet the requirements of the most severe installation conditions. This decision has led to a clear improvement in the quality of all of our products, as well as simplifying product management, which offers an advantage to Distribution, making it able to offer end Clients more efficient service.

Parallel to its production of terminal blocks and boards, Cabur also offers a complete line of electronic products for electrical panels used to automate systems and machines and for process control. These are products designed for ease of use and simple materials management, thanks to the inclusion of the most innovative technology available.

The new **line of marking products** completes the range, with innovative printing solutions - tags for wires, terminal blocks and push-buttons, tags and modular strips for electrical distribution boards.

High quality... mass produced

We guarantee complete effectiveness for our contacts and the utmost flexibility in connection solutions.

A complete array of standard products for automation boards is always available at the larger Distributors, while the support offered by the Cabur sales network and its technicians, both in Italy and abroad, makes it possible to make the right choices for optimal usage.

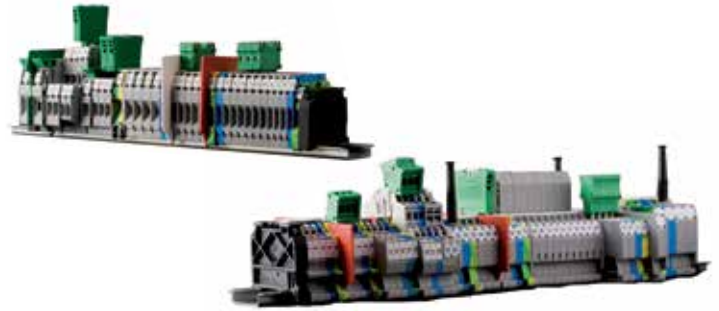

Directive 2002/95/EC



Directive 2002/95/EC is better known as RoHS and deals with the restrictions on use of certain dangerous substances in electric and electronic devices. This Directive applies exclusively to devices that fall within the merchandise categories identified in annex 1A of Directive 2002/95/EC, better known as WEEE, with the exclusion of categories 8 and 9:

1. Large household appliances (with the exception of stationary large-scale ones).
2. Small household appliances.
3. IT and telecommunications equipment.
4. Consumer equipment.
5. Lighting equipment.
6. Electric and electronic tools (with the exception of large-scale stationary industrial tools).
7. Toys, leisure, and sports equipment.
10. Automatic dispensers.

Conformance of Cabur products to the RoHS Directive

In general, Cabur products are intended for use in electrical distribution boards and industrial automation boards. Therefore, they fall into the category which is exempt from application of the RoHS Directive as they are components of "stationary industrial tools" and "stationary appliances".

Nonetheless, in consideration of the needs of those customers who use Cabur products to complete equipment and devices that are subject to the Directive, we have decided to ensure that our products meet the requirements envisaged. In 2006 we began to dispose of products that did not meet the requirements of RoHS, not just limiting ourselves to reducing the amount of harmful substances, but working to completely eliminate them from the components we produce, with a Zero Tolerance policy.

The small percentage of our products that still remain non-conformant is due to a limited number of products for which we have not yet been able to find alternative processes or materials to insert in the production cycle. In any case, we note again that these items are destined for use in merchandise categories for which the Directive **does not apply**. Our staff is happy to provide you with any additional information about our products as well as the application of the Directive in question.

You can find additional information on our website www.cabur.eu

The EC label



All the products in this catalogue meet the requirements of the applicable EC Directives in effect as of the printing date, and as a consequence, the required EC mark is found either on the product or the documentation for the product in question.

Our staff is happy to provide you with any additional information and/or clarifications regarding the reference norms and Cabur Customer Service Assistance can provide you with the declarations of conformance for the reference norms, certifications, and EC marks.





Marking systems

CaburJet System	pg. 10
Inserting cards into the automatic feeder and printing remnants	pg. 11
Inserting single sheet labels	pg. 11
CaburPlot System	pg. 12
MarKing Pro	pg. 14

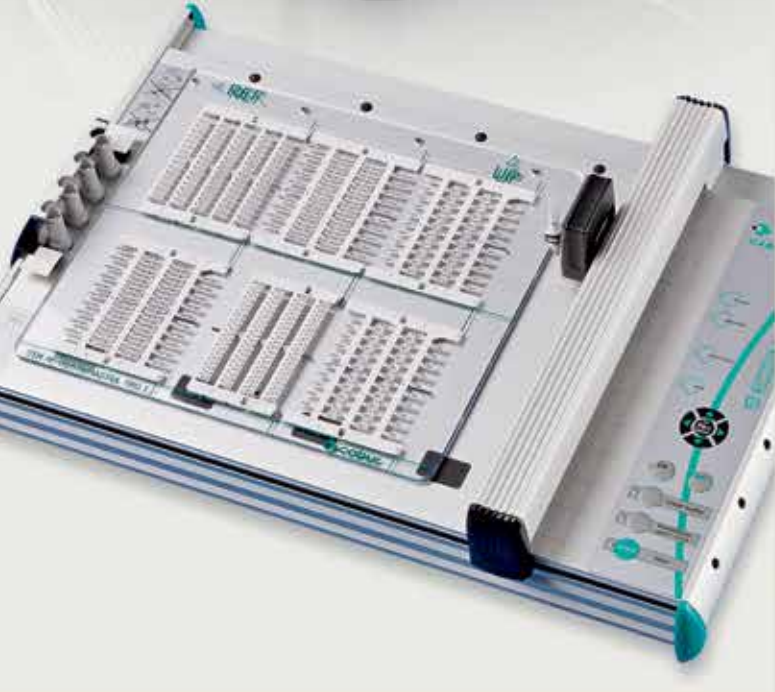

CaburJet System

Code: CABURJET - ID code: CABURJET

The CaburJet inkjet printer has a smaller size to reduce bulk and offers an innovative design, aimed at making it fast and easy to use, with no maintenance problems.

It's the ideal solution for continuous, automatic, and fast printing of:

- tags for sleeves to identify wires;
- tags for terminal blocks;
- tags for push-buttons;
- tags for contactors;
- modular strips for electrical distribution boards;
- panel identification tags.

This is a highly innovative solution, created to meet multiple needs **in the industrial field**, at a competitive price.

The printer has an automatic integrated feeder (SEPARATOR), which accepts all of the above mentioned products - even mixed. It is also possible to print on individual stems by simply placing them at the bottom of the feeder like a normal sheet of paper.

The feeder can hold 50 cards for a total of 3,000 NUT12 series tags (tags for 12 mm long sleeves).

After just an hour of printing, 24,000 tags are ready for use. The material used (self-extinguishing polycarbonate) for production of the cards, together with the ink, means that the card can be used almost immediately after printing, and is indelible in accordance with CEI 16-7.



TECHNICAL DATA

Printing technology	monochromatic inkjet printing
Interface	USB 2.0
Resolution	360 Dpi
Ink	refillable bottles
Print Speed	24,000 tags per hour
Windows support	for PC systems with Windows 98 SP2 and later
Dimensions (LxWxH)	330 x 370 x 220 mm
Weight	approx. 12 Kg.
Electricity consumption	during printing, 24W max. with compressor on, 35W
Power supply voltage	115-230V

THE PACKAGE INCLUDES:

- 1 CaburJet printer
- 1 USB cable
- 1 Power cable
- 1 80 ml bottle of ink
- 1 250 ml bottle of cleaner
- 1 copy of MarKing Pro software; including a licence for 5 installations, and a digital user manual



Inserting cards into the automatic feeder and printing remnants

All cards use the automatic feeder, except for adhesive tags and plates. The feeder is very easy to use: a key on the side of the feeder guarantees articles are loaded in one way only. The last stem in the table must be present on the incomplete card in order for it to be used, and the central peg must be positioned in the groove at the centre of the printing surface. It does not need to be aligned exactly. The pushers will convey and, if necessary, straighten the incomplete card.



1 Insert the material in the feeder.



2 Print.

Inserting single sheet labels (e.g. remnants, adhesive tags and tags)

To print onto remnants or articles that cannot be used with the automatic feeder (e.g. adhesive labels), place the articles directly onto the printing surface past the pushers.

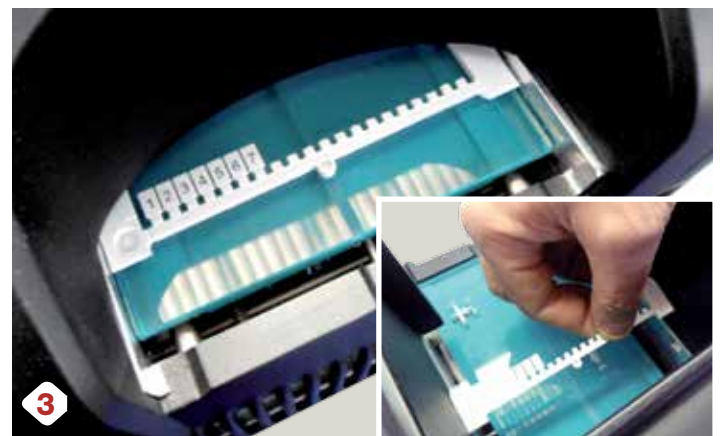

3 Print remnants.



4 Place the labels directly onto the printing surface.

ACCESSORIES AND SPARE PARTS

CODE	ID CODE	DESCRIPTION
INKBJET	INKBJET	black ink in hermetically sealed 80 ml containers
CLNRJET	CLNRJET	cleaner in hermetically sealed 250 ml containers



ADVANTAGES

PLUG & PRINT TECHNOLOGY

DOES NOT REQUIRE INSTALLATION OR CONFIGURATION

SO EASY TO USE THAT NO USER MANUAL IS NEEDED

SMALL: REDUCED SIZE FOR MINIMUM BULK

PRINTS REMNANTS

MADE FROM DURABLE STEEL AND ALUMINIUM

UNIVERSAL FEEDER

EASY ACCESS TO CHANGE THE INK - SEPARATOR

CaburPlot System

Code: KSLOTTER - ID Code CABURPLOT

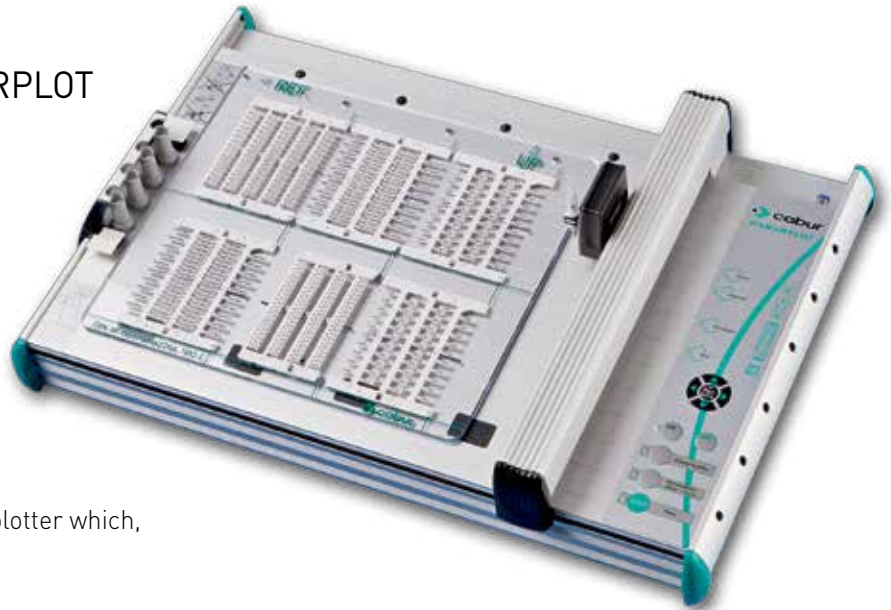

The CABURPLOT system consists of a flatbed A3 plotter which, on a single plate, lets you print on:

- tags for sleeves to identify wires;
- tags for terminal blocks;
- tags for push-buttons;
- tags for contactors;
- modular strips for electrical distribution boards;
- panel identification tags.

The aluminium frame and innovative design, as opposed to other solutions available on the market, make CABURPLOT a leading, state of the art system. Compared to similar products, CABURPLOT pens last longer. In addition to the classic, anti-dry pen, we've added an extra stand-by position built into the system: **a special airtight pen holder**, which prevents accidental tampering and laborious manual operations outside the system.

TECHNICAL DATA

Type	flat base plotter
Printing area	440 x 305 mm
Pen holder	4
Power supply	separate power supply unit
Input voltage	100 - 240V AC 50 - 60Hz
Output Voltage	24V D.C.
PC interface	parallel and USB 1.1
Dimensions	660 x 440 x 125 mm
Weight	8 Kg

THE PACKAGE INCLUDES:

- 1 KSLOTTER plotter
- 1 Power supply
- 1 Parallel cable
- 1 USB cable
- 1 USB/parallel cable
- 1 adaptation plate, code PADCABUR
- 1 anti-dry pen, diameter 0.35 mm
- 1 pack of 5 extra indelible black ink cartridges
- 1 copy of MarKing Pro software on CD; including a licence for 5 installations, and a digital user manual

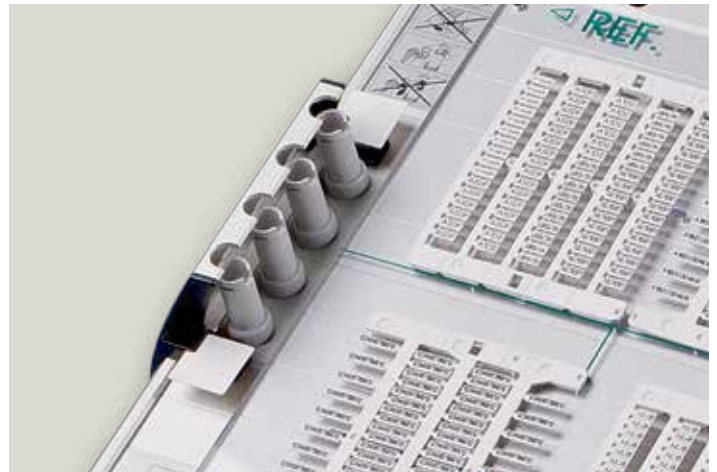

Pen holder.



Control panel.

CaburPlot System

Accessories, spare parts, and adapter kit



INKBOTT1



KITPULIZIA



PEN035CAB



INKCART5



POMPASP



PEN025CAB



PADCABUR



PEN035GRA

ACCESSORIES

CODE	ID CODE	DESCRIPTION
PADCABUR	PADCABUR	adaptation plate for KSLOTTER plotter
PADGRAPH	PADGRAPH	adaptation plate for Graphtec plotter
PADMUTH0	PADMUTH0	adaptation plate for MUTOH plotter
PEN025CAB	PEN025CAB	antidessication pen for plotter – diameter 0.25 mm
PEN035CAB	PEN035CAB	antidessication pen for plotter – diameter 0.35 mm
PEN035GRA	PEN035GRA	antidessication pen for Graphtec plotter – diameter 0.25 mm
INKCART5	INKCART5	indelible ink (5 cartridges per pack)
INKBOTT1	INKBOTT1	30 ml bottle of ink
KITPULIZIA	KITPULIZIA	pen cleaning kit
POMPASP	POMPASP	reactivating pen

ADAPTER KIT FOR OTHER PLOTTERS

CODE	ID CODE	DESCRIPTION
ADRKITEK	KITCABUREK	MarKing Pro SW + EK-TEAM VP-500 plotter plate
ADRKITGR	KITCABURBG	MarKing Pro SW + GRAPHTEC plotter plate
ADRKITMU	KITCABURMU	MarKing Pro SW + MUTOH IP-220 plotter plate

MarKing Pro

Software for marking

Code: SWMP2 - ID code: SWMP2

MarKing Pro is an application to be used to print characters and images on tags and cards, monochromatically. It can be used with the CaburJet printer and CaburPlot plotter, among others.

The program, **which is easy to use and extremely versatile**, allows the user to define the marking parameters, with character and symbol sequences that can be adjusted to meet the needs of the users, and prints them on Cabur tags, which can be selected from a database inserted with the software.

The software allows automatic importing of data for marking of wires, terminal blocks, and equipment in general for the most common electric CADs, such as SPAC Automazione, IGE-XAO, and ELETTRIO GRAPHICS.

The MarKing system makes it possible to use both the Plotter and CaburJet systems simultaneously. If used with the plotter system, the software can manage up to a maximum of 5 peripherals.

If used with Caburjet, the maximum number of peripherals that can be managed depends on the number of USB ports available on the PC.

Thanks to its **intuitive interface** and visual elements, MarKing Pro is easy to use, makes it possible to view the end result before printing, and does not require any special technical skills.

Cabur also offers a **labelling creation service**, which can be provided on the basis of files created in MarKing Pro by the customer. Send Cabur your MarKing Pro files to receive a quotation and service that provides the utmost in efficiency as well as reliable results.

Technical requirements for installation:

Platform: PC

Operating system:

- for use with CaburJet: Microsoft® Windows™ 98 SP2 or later;
- for use with CaburPlot: Microsoft® Windows™ 95 or later.

Memory: 512 MB RAM minimum

Space available on hard disk: minimum 50 MB

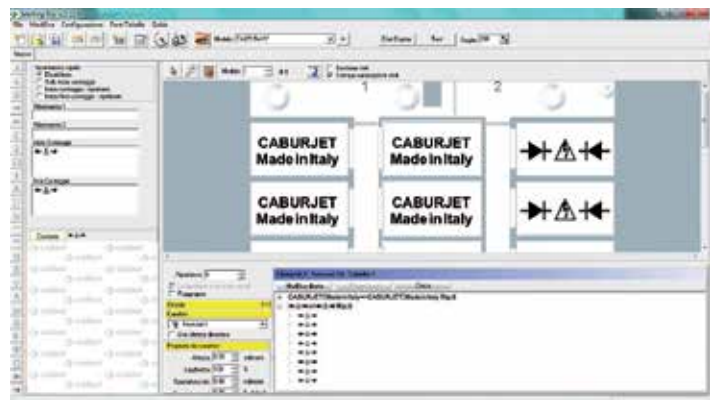
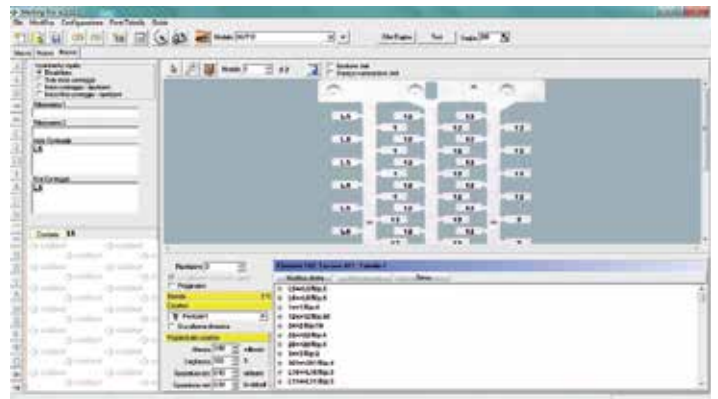
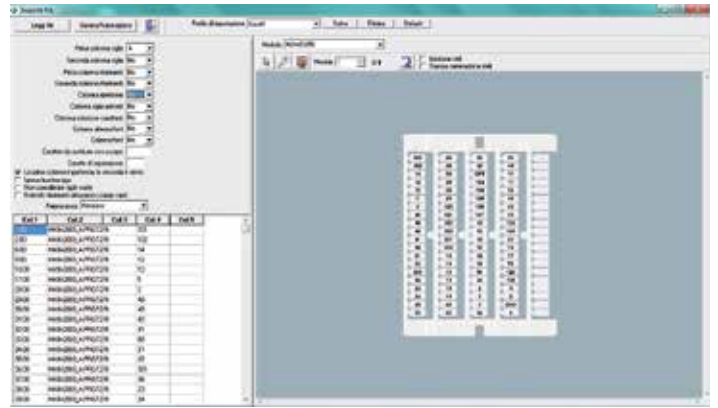

Advantages offered by MarKing Pro

1. Ease and speed of importing from electric CAD and xls, csv and txt files
2. Thanks to the universal feeder, various print jobs can be sent in a single batch
3. Option to identify "preferred" items and those normally used, avoiding the need to select them each time from the main list.



Products for marking

Tags for wires	pg. 16
Transparent sleeves for tags	pg. 17
Wire-labelling tags for wires with 2.6 - 4.2 mm external diameters	pg. 18
Tags for Cabur terminal blocks	pg. 19
Tags for other terminal blocks	pg. 20
Assembly of stepped tags on terminal blocks	pg. 21
Tags for contactors and meters	pg. 22
Slotted sleeves	pg. 23
Rails for TA 209W/Y	pg. 23
Labels for modular switch strips and equipment	pg. 24
Adhesive tags for distribution panels	pg. 24
Rigid adhesive tags	pg. 24
Tags for tag holders and rails	pg. 25
Protective clear covers for tags	pg. 26
Tag holders	pg. 26
Adhesive tag holders	pg. 27
Slotted sleeves for tags	pg. 27
Tag holders for identification of groups of terminal blocks	pg. 28
Strips for rails and adhesive strips	pg. 28
Rails	pg. 29
Panel identification tags	pg. 29

Tags for wires

Tags for sleeves, available in lengths from 12 to 23 mm, yellow or white, for use with TUB series sleeves. Can be printed with CaburJet and CaburPlot.

- Material: 1.6mm self-extinguishing polycarbonate (halogen-free)
- Self-extinguishing: UL 94-V0
- Working temperature: -40° / +80°
- Rub resistance: CEI 16-7.
- Ageing and UV resistance: conformant with UNI EN ISO4892-1-2

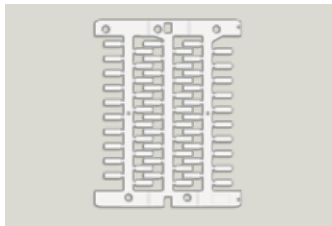
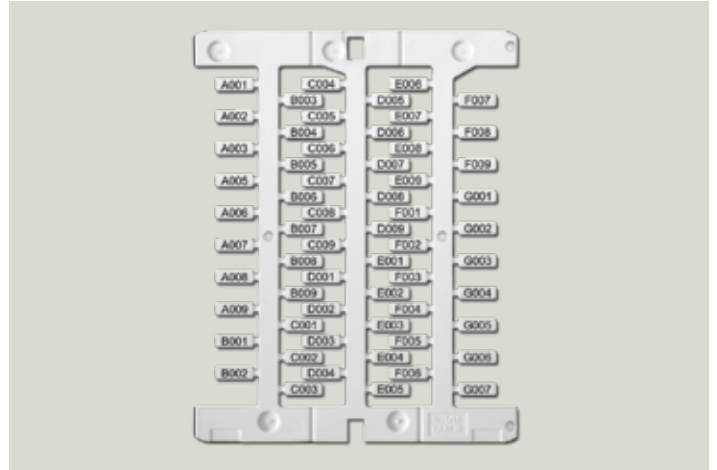

TAG CARD L. 12 MM

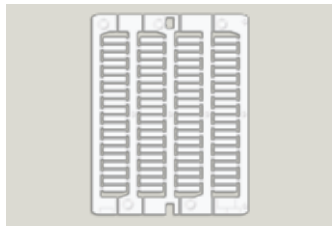

TAG CARD L. 15 MM

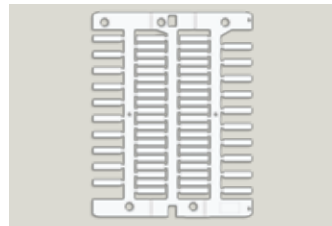

TAG CARD L. 18 MM

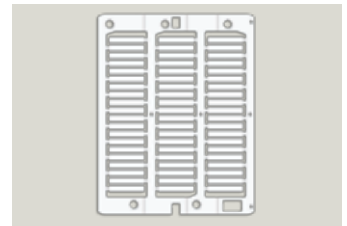

TAG CARD L. 23 MM

CODE	ID CODE	DESCRIPTION	SIZE IN mm		COLOUR	PIECES PK.
			LENGTH	HEIGHT		
NUT12	NUT 12	tags for sleeves	12	4	white	1,500
NUT12Y	NUT 12	tags for sleeves	12	4	yellow	1,500
NUT15	NUT 15	tags for sleeves	15	4	white	2,000
NUT15Y	NUT 15	tags for sleeves	15	4	yellow	2,000
NUT18	NUT 18	tags for sleeves	18	4	white	1,500
NUT18Y	NUT 18	tags for sleeves	18	4	yellow	1,500
NUT23	NUT 23	tags for sleeves	23	4	white	1,500
NUT23Y	NUT 23	tags for sleeves	23	4	yellow	1,500

NUMBER OF CHARACTERS PRINTABLE ESTIMATED BASED ON THE MOST COMMON FONTS

TAG LENGTH	NUMBER OF STANDARD CHARACTERS	NUMBER OF COMPRESSED CHARACTERS
10 mm	6	7
12 mm	7	10
15 mm	8	12
18 mm	10	14
23 mm	15	18



Transparent sleeves for tags

Transparent PVC sleeve, width 4 mm, available in lengths from 12 to 23 mm, for use with NUT series tags. Appropriate for identification of wire sections, from a minimum of 0.22 mm² up to a maximum of 35 mm².

- Material: PVC (polyvinyl chloride)
- Self-extinguishing: UL94-V0
- Working temperature: -40° / +80°



TUB12



TUB15



TUB18



TUB23

CODE	ID CODE	DESCRIPTION	SIZE IN mm		WIRE SECTION	WIRE DIAMETER	PIECES PK.
			LENGTH	WIDTH	MIN - MAX IN mm ²	MIN - MAX IN mm	
TUB1200	TUB1200	transparent sleeve	12	4	0.22 - 0.5 mm ²	from 1 mm to 2 mm	1,000
TUB1201	TUB1201	transparent sleeve	12	4	0.5 - 1.5 mm ²	from 1.8 mm to 2.5 mm	3,000
TUB1202	TUB1202	transparent sleeve	12	4	0.5 - 2.5 mm ²	from 2 mm to 4.1 mm	3,000
TUB1203	TUB1203	transparent sleeve	12	4	2.5 - 10 mm ²	from 4 mm to 6.8 mm	1,000
TUB1204	TUB1204	transparent sleeve	12	4	2.5 - 16 mm ²	from 6 mm to 9.5 mm	500
TUB1205	TUB1205	transparent sleeve	12	4	4.0 - 35 mm ²	from 9.6 mm to 13.5 mm	500
TUB1500	TUB1500	transparent sleeve	15	4	0.22 - 0.5 mm ²	from 1 mm to 2 mm	1,000
TUB1501	TUB1501	transparent sleeve	15	4	0.5 - 1.5 mm ²	from 1.8 mm to 2.5 mm	3,000
TUB1502	TUB1502	transparent sleeve	15	4	0.5 - 2.5 mm ²	from 2 mm to 4.1 mm	3,000
TUB1503	TUB1503	transparent sleeve	15	4	2.5 - 10 mm ²	from 4 mm to 6.8 mm	1,000
TUB1504	TUB1504	transparent sleeve	15	4	2.5 - 16 mm ²	from 6 mm to 9.5 mm	500
TUB1505	TUB1505	transparent sleeve	15	4	4.0 - 35 mm ²	from 9.6 mm to 13.5 mm	500
TUB1800	TUB1800	transparent sleeve	18	4	0.22 - 0.5 mm ²	from 1 mm to 2 mm	1,000
TUB1801	TUB1801	transparent sleeve	18	4	0.5 - 1.5 mm ²	from 1.8 mm to 2.5 mm	3,000
TUB1802	TUB1802	transparent sleeve	18	4	0.5 - 2.5 mm ²	from 2 mm to 4.1 mm	3,000
TUB1803	TUB1803	transparent sleeve	18	4	2.5 - 10 mm ²	from 4 mm to 6.8 mm	1,000
TUB1804	TUB1804	transparent sleeve	18	4	2.5 - 16 mm ²	from 6 mm to 9.5 mm	500
TUB1805	TUB1805	transparent sleeve	18	4	4.0 - 35 mm ²	from 9.6 mm to 13.5 mm	500
TUB2300	TUB2300	transparent sleeve	23	4	0.22 - 0.5 mm ²	from 1 mm to 2 mm	1,000
TUB2301	TUB2301	transparent sleeve	23	4	0.5 - 1.5 mm ²	from 1.8 mm to 2.5 mm	3,000
TUB2302	TUB2302	transparent sleeve	23	4	0.5 - 2.5 mm ²	from 2 mm to 4.1 mm	3,000
TUB2303	TUB2303	transparent sleeve	23	4	2.5 - 10 mm ²	from 4 mm to 6.8 mm	1,000
TUB2304	TUB2304	transparent sleeve	23	4	2.5 - 16 mm ²	from 6 mm to 9.5 mm	500
TUB2305	TUB2305	transparent sleeve	23	4	4.0 - 35 mm ²	from 9.6 mm to 13.5 mm	500

Wire-labelling tags for wires with 2.6 - 4.2 mm external diameters

- Wire-labelling tags for wires with 2.6 - 4.2 mm external diameters indicative section 1-1.5 - 2.5-4 mm², available in lengths of 16 mm.
- Direct insertion on the wire without the need for a sleeve.
- Colours: white and yellow.
- Can be printed with CaburJet.
 - Material: polycarbonate
 - Self-extinguishing: V0 (1.6 mm thick) UL 94-HF
 - Working temperature: -40° / +80°
 - Rub resistance: CEI 16-7.
- Ageing and UV resistance: conformant with UNI EN ISO4892-1-2

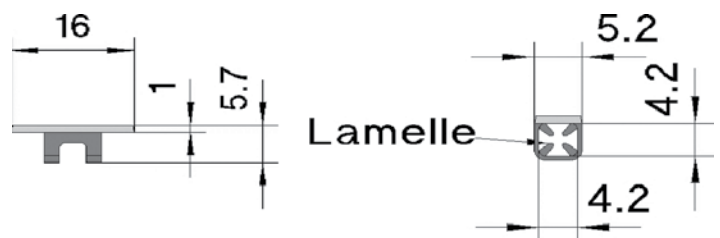
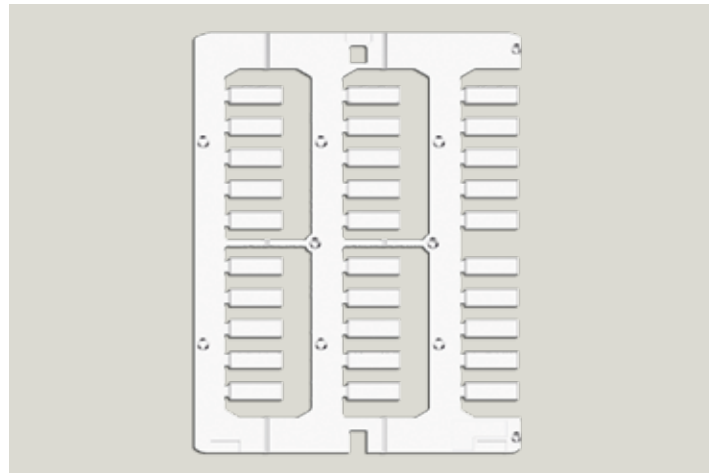

CODE	ID CODE	DESCRIPTION	DIMENSIONS IN MM		CROSS-SECTION OF THE WIRE	DIAMETER OF THE WIRE	PIECES PK
			LENGTH	WIDTH			
TMC16040W*	TMC16040W	white wire-labelling tag	16	5.2	1-- 4 mm ²	2.6--4.2 mm	1,080
TMC16040Y*	TMC16040Y	yellow wire-labelling tag	16	5.2	1-- 4 mm ²	2.6--4.2 mm	1,080

*Available in September 2012

Tags for Cabur terminal blocks

White tags for terminal blocks, available in lengths from 8 and 10 mm, appropriate for use with all Cabur terminal blocks. Can be printed with CaburJet and CaburPlot.

- Material: 1.6 mm self-extinguishing polycarbonate (halogen-free)
- Self-extinguishing: UL 94-V0
- Working temperature: -40° / +80°
- Rub resistance: CEI 16-7.
- Ageing and UV resistance: conformant with UNI EN ISO4892-1-2

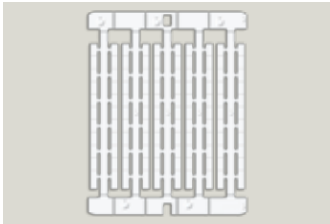
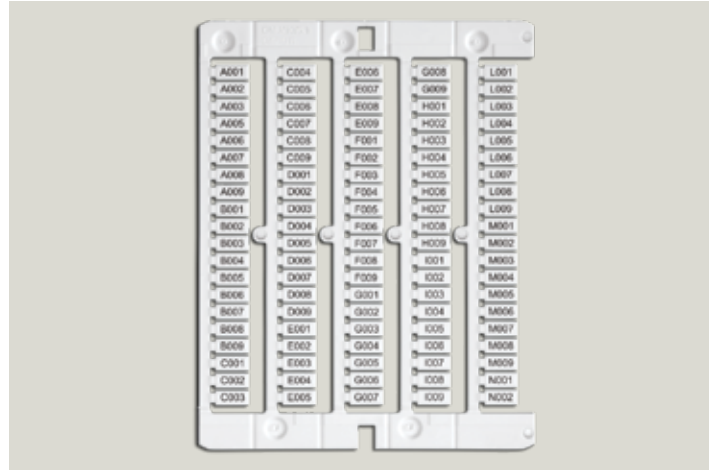

NU0800*

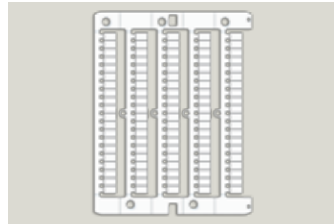

NU0851

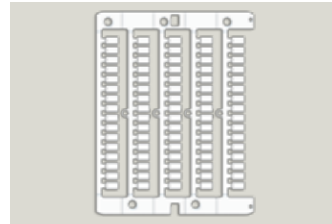

NU0861

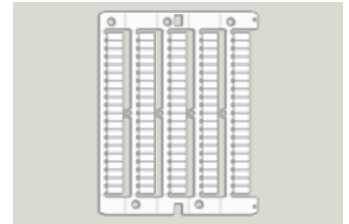

NU1051

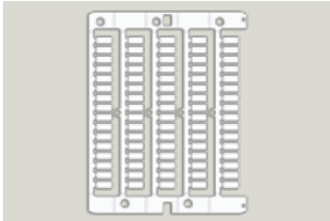

NU1061

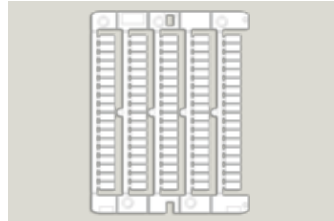

NU1055

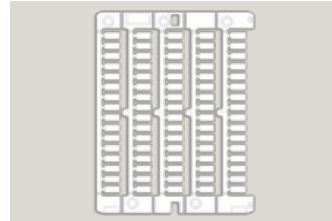

NU1065



SH004

CODE	ID CODE	DESCRIPTION	SIZE IN mm		COLOUR	PIECES PK.
			LENGTH	HEIGHT		
NU0800	NU0800	tags for terminal blocks from Cabur Series CBC - CBD - HMM, universal, single tag mounting	08	5	white	1,500
NU0851	NU0851	tags for Cabur terminal blocks CBC-CBD-HMM multiple mounting on CBC.2, single tags on all other sections	08	5	white	1,500
NU0861	NU0861	tags for Cabur terminal blocks CBC-CBD-HMM multiple mounting on CBC.4, single tags on all other sections	08	5	white	1,200
NU1051	NU1051	tags for Cabur terminal blocks CBC-CBD-HMM multiple mounting on CBC.2, single tags on all other sections	10	5	white	1,500
NU1061	NU1061	tags for Cabur terminal blocks CBC-CBD-HMM multiple mounting on CBC.4, single tags on all other sections	10	5	white	1,200
NU1055	NU1055	tags for Cabur terminal blocks CBC-CBD-HMM multiple mounting on CBD.2, single tags on all other sections	10	5	white	1,350
NU1065	NU1065	tags for Cabur terminal blocks CBC-CBD-HMM multiple mounting on CBD.4 single tags on all other sections	10	5	white	1,200
SH004	SHZ.1	pitch tags for Cabur HMM.1 terminal blocks	10	4.2	white	1,500



Tags for other terminal blocks

White terminal block tags, available in lengths from 8 to 10 mm, appropriate for use on Contaclip, Entrelec, Klemсан, Legrand, Morsettitalia, Phoenix, Wago, Weidmuller, and Wieland terminal blocks. For use with both CaburJet and CaburPlot.

- Material: 1.6 mm self-extinguishing polycarbonate (halogen-free)
- Self-extinguishing: UL 94-V0
- Working temperature: -40° / +80°
- Rub resistance: CEI 16-7.
- Ageing and UV resistance: conformant with UNI EN ISO4892-1-2

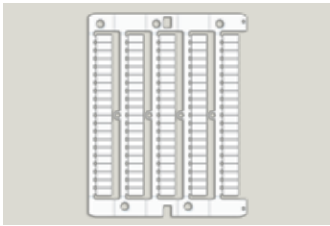
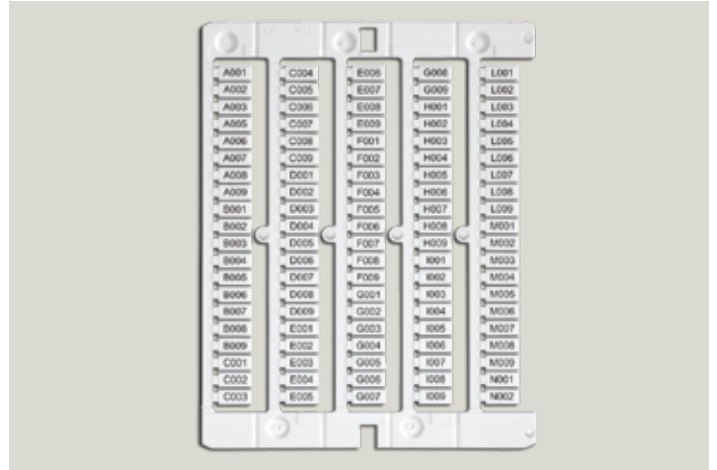

NUWDU50

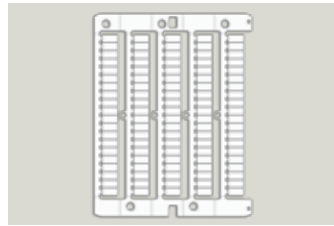

NUWDK50

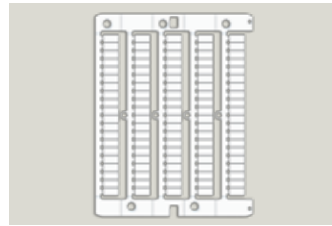

NUWPUTUK50

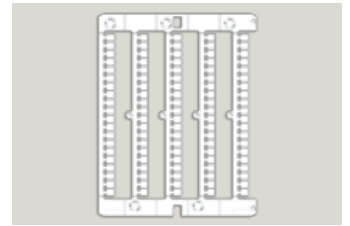

NU0550

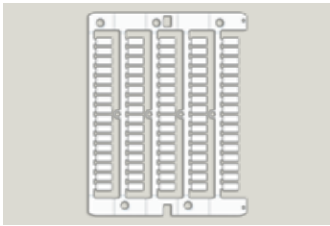

NUL1061

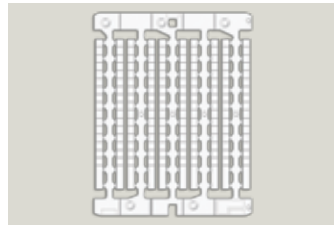

NUWG050

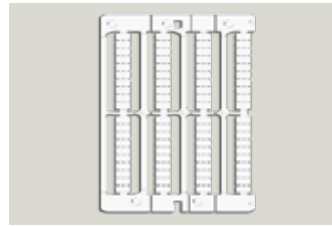

NUWG051

CODE	ID CODE	DESCRIPTION	SIZE IN mm		COLOUR	PIECES PK.
			LENGTH	HEIGHT		
NUWDU50	NUWDU50	tag for Weidmuller terminal blocks, WDU-ZDU series, Klemсан, Contaclip, Connectwell, and Wago 870, multiple mounting on 2.5 sections, single tag on all other sections	10	5	white	1,500
NUWDK50	NUWDK50	tag for Weidmuller terminal blocks, WDK-ZDK series, multiple mounting on 2.5 sections, single tags on all other sections	10	5	white	1,500
NUPUTUK50	NUPUTUK50	tag for Phoenix terminal blocks, UT-UK-ST series, multiple on Entrelec and Wago 280 2.5 sections, single tags on all other sections	10	5	white	1,500
NU0550	NU0550	tag for BPL-TPL terminal blocks, multiple mounting on WDU2.5	5	5	white	1,500
NUL1061	NUL1061	tag for Legrand, Telemecanique-Schneider, Wieland terminal blocks, multiple mounting on 4 mm ² sections, single tags on all other sections.	10	5	white	1,275
NUWG050	NUWG050	tag mounting pitch for WAGO 769 series, I/O750, Beckhoff	5	5	white	2,400
NUWG051	NUWG051	universal tag for WAGO terminal blocks	10	5	white	1,600

Assembly of stepped tags on terminal blocks



1 Remove the stem from the card.



2 Remove the pre-notched heads from the stem.



2 Insert the tags directly into the terminal block series using light pressure.



3 Remove the remaining stem, turning it downwards.

NUMBER OF CHARACTERS PRINTABLE ESTIMATED ON THE BASIS OF THE MOST COMMON FONTS FOR CABUR AND OTHER BRANDS' TAGS

LENGTH	NUMBER OF STANDARD CHARACTERS	NUMBER OF COMPRESSED CHARACTERS
08 mm	4	6
10 mm	6	7
12 mm	7	10
15 mm	8	12
18 mm	10	14
23 mm	15	18

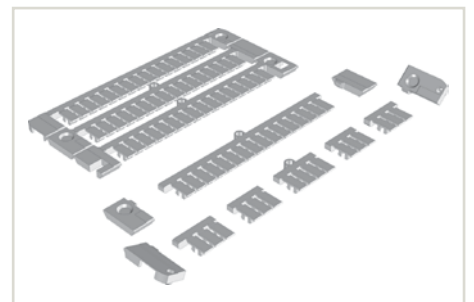
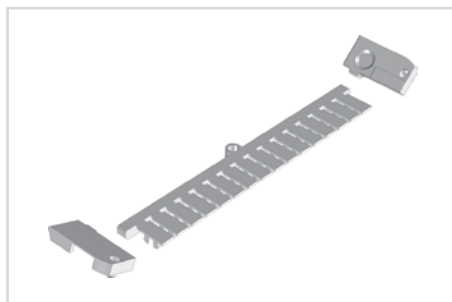
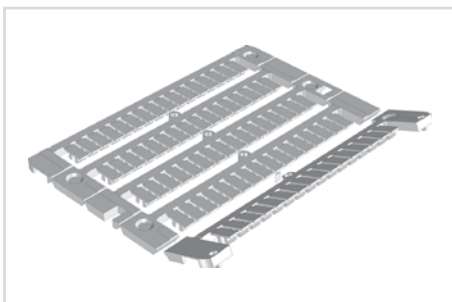

Each marking card for the entire series of terminal blocks was designed for batteries of terminal blocks and can be broken into elements appropriate for use in areas with limited space. The stem can be torn only for tags for Cabur terminal blocks.

Tags for contactors

Appropriate for Siemens and Telemecanique series contactors
Can be printed with CaburJet and CaburPlot.

- Material: 1.6 mm self-extinguishing polycarbonate (halogen-free)
- Self-extinguishing: UL 94-V0
- Working temperature: -40° / +80°
- Rub resistance: CEI 16-7.
- Ageing and UV resistance:
conformant with UNI EN ISO4892-1-2

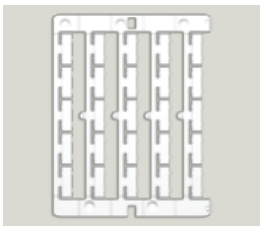
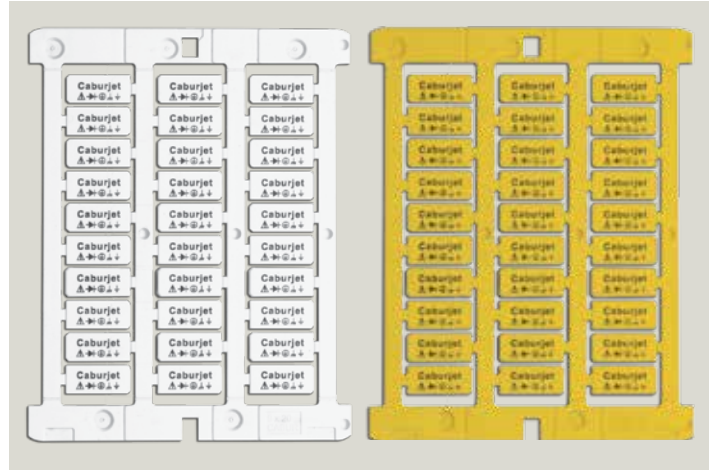

TA207S

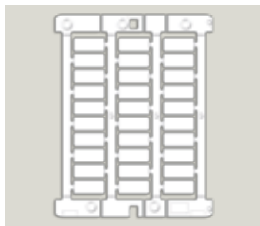

TA209W

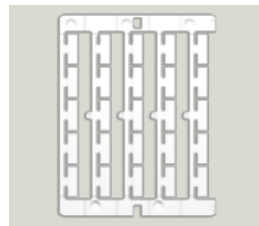

TA1808T



CODE	ID CODE	DESCRIPTION	PIECES PK.
TA207S	TA207S	tag for Siemens Sirius 3R contactors 7 x 20 mm	375
TA1808T	TA1808T	tag for Telemecanique contactors 9X20 mm	375
TA209S0	TA209S0	tag for Siemens, Moeller, Pilz, Festo contactors	375
TA209W	TA209W	white tag for slotted sleeve 9x20 mm and rail	450
TA209Y	TA209Y	yellow tag for slotted sleeve 9x20 mm and rail	300
TA359W	TA359W	white tag for TUB359 slotted sleeve 9x35	240
TAG209AW	TAG209AW	white adhesive tag for equipment 9x20 mm	450
TAG209AY	TAG209AY	yellow adhesive tag for equipment 9x20 mm	450

Slotted sleeve

CODE	ID CODE	DESCRIPTION	PIECES PK.
TUB209	TUB209	slotted sleeve for TA209W/Y	1,000
TUB359	TUB359	description: double slotted sleeve for TA359W	500



Slotted sleeve.

Rail for TA209W/Y

CODE	ID CODE	DESCRIPTION	PIECES PK.
BIN5009A	BIN5009A	adhesive rail for TA209W/Y length 500 mm height 9 mm used to place the rail for long-lasting fixture rivets are recommended	20
BIN10009A	BIN10009A	adhesive rail for TA209W/Y length 1,000 mm height 9 mm used to place the rail for long-lasting fixture rivets are recommended	20
BIN5009AHP	BIN5009AHP	high resistance adhesive rail for TA209W/Y length: 500 mm height 9 mm	20
BIN10009AHP	BIN10009AHP	high resistance adhesive rail for TA209W/Y length: 1,000 mm height 9 mm	20



BIN5009A

Labels for equipment and strips for modular switches

Polycarbonate labels, 0.65 micron, adhesive, for use only with CaburJet.

- Material: polycarbonate
- Self-extinguishing: UL94-V0
- Working temperature: -40° / +80°
- Rub resistance: CEI 16-7.
- Adhesive: acrylic Lohmann DuploCOLL 50U E Lohmann DuploCOLL 100U
- Ageing and UV resistance: conformant with UNI EN ISO4892-1-2

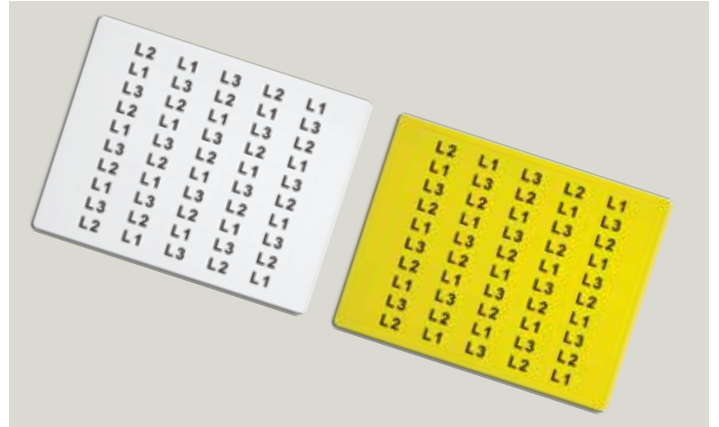

CODE	ID CODE	DESCRIPTION	PIECES PK.
TA209AW	TA209AW	0.65 micron white adhesive pc label for equipment 9 x 20 mm single sheet	500
TA209AY	TA209AY	0.65 micron yellow adhesive pc label for equipment 9 x 20 mm single sheet	500
TA178AW	TA178AW	0.65 micron white adhesive pc label for equipment 8 x 17 mm single sheet	660
TA178AY	TA178AY	0.65 micron yellow adhesive pc label for equipment 8 x 17 mm single sheet	660
TA156AW	TA156AW	0.65 micron white adhesive pc label for equipment 6 x 15 mm single sheet	1,050
TA156AY	TA156AY	0.65 micron yellow adhesive pc label for equipment 6 x 15 mm single sheet	1,050
TA128AW	TA128AW	0.65 micron white adhesive pc label for equipment 8 x 12 mm single sheet	900
TA128AY	TA128AY	0.65 micron yellow adhesive pc label for equipment 8 x 12 mm single sheet	900
TA207AW	TA207AW	0.65 micron white adhesive pc label for equipment 7 x 20 mm single sheet	500
TA207AY	TA207AY	0.65 micron yellow adhesive pc label for equipment 7 x 20 mm single sheet	500
TA1517AW	TA1517AW	0.65 micron white adhesive pc label for equipment 15 x 17 mm single sheet	360
ST10512W	ST10512W	non-adhesive pc strip 105 x 12 mm for BT DIN, Bticino, and Legrand	80
TA2715AM	TA2715AM	0.65 micron metal adhesive pc label for equipment 15 x 27 mm	200
TA5015AM	TA5015AM	0.65 micron metal adhesive pc label for equipment 15 x 50 mm	100
TA6715AM	TA6715AM	0.65 micron metal adhesive pc label for equipment 15 x 67 mm	50
TA159AW	TA159AW	0.65 micron white adhesive pc label for equipment 9x15 mm single sheet	600
TA159AY	TA159AY	0.65 micron yellow adhesive pc label for equipment 9x15 mm single sheet	600

Adhesive tags for distribution boards

Appropriate for identifying energy distribution boards. Due to the high degree of adhesiveness, they are particularly recommended for use with boards painted in high-gloss. Only for printing with CaburJet.

- Material: polycarbonate
- Self-extinguishing: UL94-V0
- Working temperature: -40° / +80°
- Rub resistance: CEI 16-7.
- Halogen: HF
- Adhesive: acrylic Lohmann DuploCOLL 50U E Lohmann DuploCOLL 100U
- Ageing and UV resistance: conformant with UNI EN ISO4892-1-2



CODE	ID CODE	DESCRIPTION	PIECES PK.
TA2080AM	TA2080AM	0.65 micron metal adhesive pc tag for equipment 20 x 80 mm single sheet	40
TA2080AW	TA2080AW	0.65 micron white adhesive pc tag for equipment 20 x 80 mm single sheet	40
TA2080AY	TA2080AY	0.65 micron yellow adhesive pc tag for equipment 20 x 80 mm single sheet	40
TA3070AM	TA3070AM	0.65 micron metal adhesive pc tag for equipment 30 x 70 mm single sheet	40
TA3070AW	TA3070AW	0.65 micron white adhesive pc tag for equipment 30 x 70 mm single sheet	30
TA3070AY	TA3070AY	0.65 micron yellow adhesive pc tag for equipment 30 x 70 mm single sheet	30
TA407AW	TA407AW	7x40 mm adhesive tag for PTMS tag holder	360
TA4090AM	TA4090AM	0.65 micron metal adhesive pc tag for equipment 40 x 90 mm single sheet	20
TA4090AW	TA4090AW	0.65 micron white adhesive pc tag for equipment 40 x 90 mm single sheet	20
TA4090AY	TA4090AY	0.65 micron yellow adhesive pc tag for equipment 40 x 90 mm single sheet	20
TA60100AM	TA60100AM	0.65 micron metal adhesive pc tag for equipment 60 x 100 mm single sheet	10
TA60100AW	TA60100AW	0.65 micron WHITE adhesive pc tag for equipment 60 x 100 mm single sheet	10
TA60100AY	TA60100AY	0.65 micron yellow adhesive pc tag for equipment 60 x 100 mm single sheet	10
TA80100AM	TA80100AM	0.65 micron metal adhesive pc tag for equipment 80 x 100 mm single sheet	10
TA80100AW	TA80100AW	0.65 micron white adhesive pc tag for equipment 80 x 100 mm single sheet	10
TA80100AY	TA80100AY	0.65 micron yellow adhesive pc tag for equipment 80 x 100 mm single sheet	10
TA1640AW	TA1640AW	16x40 mm adhesive tag for PTM tag holder	150

Rigid adhesive tags

Rigid adhesive tags perfect for identifying automated boxes and panels. Available in white and yellow. Can be printed with CaburJet and CaburPlot.

- Material: polycarbonate
- Self-extinguishing: UL 94-V0
- Working temperature: -40° / +80°
- Rub resistance: CEI 16-7.
- Adhesive: 3M468MP
- Ageing and UV resistance: conformant with UNI EN ISO4892-1-2



CODE	ID CODE	DESCRIPTION	SIZE IN mm		COLOUR	PIECES PK.
			LENGTH	HEIGHT		
TAG2715AW	TAG2715AW	adhesive tag	27	15	white	270
TAG2715AY	TAG2715AY	adhesive tag	27	15	yellow	270
TAG5015AW	TAG5015AW	adhesive tag	52	15	white	150
TAG5015AY	TAG5015AY	adhesive tag	52	15	yellow	150
TAG6715AW	TAG6715AW	adhesive tag	67	15	white	75
TAG6715AY	TAG6715AY	adhesive tag	67	15	yellow	75

Tags for tag holders and rails

Tags for tag holders and rails, indispensable for identifying automated boards and panels. Available in white and yellow. Can be printed with CaburJet and with CaburPlot.

- Material: 1.6 mm self-extinguishing polycarbonate (halogen-free)
- Self-extinguishing: UL 94-V0
- Working temperature: -40° / +80°
- Rub resistance: CEI 16-7.
- Ageing and UV resistance: conformant with UNI EN ISO4892-1-2

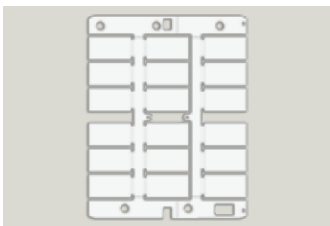

TA2715W

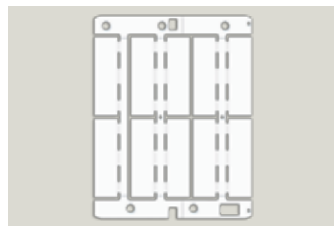

TA50115W

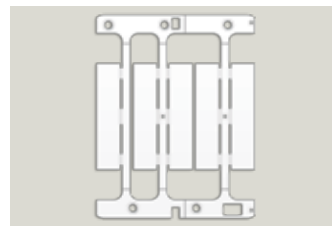

TA6715W

CODE	ID CODE	DESCRIPTION	SIZE IN mm		COLOUR	PIECES PK.
			LENGTH	HEIGHT		
TA2715W	TA2715W	tag for tag holders	27	15	white	270
TA2715Y	TA2715Y	tag for tag holders	27	15	yellow	270
TA5015W	TA5015W	tag for tag holders	52	15	white	150
TA5015Y	TA5015Y	tag for tag holders	52	15	yellow	150
TA6715W	TA6715W	tag for tag holders	67	15	white	75
TA6715Y	TA6715Y	tag for tag holders	67	15	yellow	75

Protective clear

- Material: transparent polycarbonate
- Self-extinguishing: UL 94-V0
- Working temperature: -40° / +80°
- Rub resistance: CEI 16-7.



CODE	ID CODE	DESCRIPTION	SIZE IN mm		COLOUR	PIECES PK.
			LENGTH	HEIGHT		
VET2715	VET2715	protective clear cover for tags	27	15	transparent	270
VET5215	VET5215	protective clear cover for tags	52	15	transparent	150
VET6715	VET6715	protective clear cover for tags	67	15	transparent	75

Tag holders

- Material: PA6 polyamide
- Working temperature: -40° / +80°
- Melting point: 220° C
- Halogen: HB



PT3017B

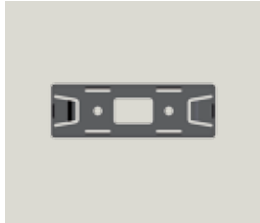

PT5217B

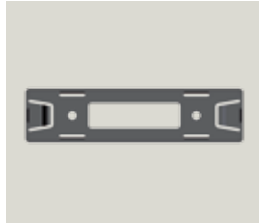

PT7017B



PTD022



PTD225

CODE	ID CODE	DESCRIPTION
PT3017B	PT3017B	tag holder for tags
PT5217B	PT5217B	tag holder for tags
PT7017B	PT7017B	tag holder for tags
PTD022	PTD022	tag holder for push-buttons Ø 22
PTD225	PTD225	tag holder for push-buttons Ø 22.5 specific for telemecanique zb4

SIZE IN mm		COLOUR	PIECES PK.
LENGTH	HEIGHT		
30	17	black	270
52	17	black	150
70	17	black	75
-	-	black	270
-	-	black	270

Adhesive tag holders

- Material: PA6 polyamide
- Working temperature: -40° / +80°
- Melting point: 220° C
- Halogen: HB



PT3017BA

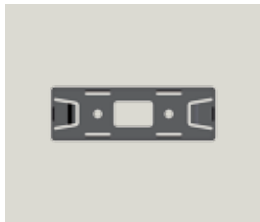

PT5217BA

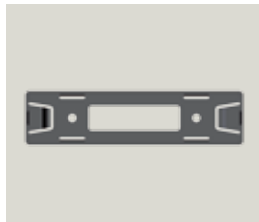

PT7017BA



PTD022A



PTD225A

CODE	ID CODE	DESCRIPTION
PT3017BA	PT3017BA	adhesive tag holder for tags
PT5217BA	PT5217BA	adhesive tag holder for tags
PT7017BA	PT7017BA	adhesive tag holder for tags
PTD022A	PTD022A	adhesive tag holder for push-buttons Ø 22
PTD225A	PTD225A	adhesive tag holder for push-buttons Ø 22.5 specific for telemecanique zb4

SIZE IN mm		COLOUR	PIECES PK.
LENGTH	HEIGHT		
30	17	black	270
52	17	black	150
70	17	black	75
-	-	black	270
-	-	black	270

Slotted sleeves for tags

Appropriate for identification of large wires or bundles of wires with the use of bands.

- Material: PVC
- Self-extinguishing: VO
- Working temperature: -40° / $+60^{\circ}$

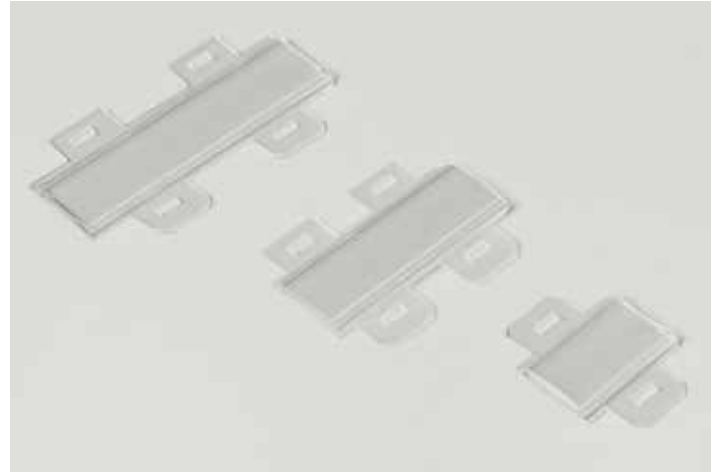

CODE	ID CODE	DESCRIPTION	PIECES PK.
TUB2715	TUB2715	slotted PVC sleeve for TA2715 tags	500
TUB5015	TUB5015	slotted PVC sleeve for TA5015 tags	250
TUB6715	TUB6715	slotted PVC sleeve for TA6715 tags	125

Tag holders for identification of groups of terminal blocks

Tags appropriate for insertion in TIM tag holders: TA5015W and TA5015Y (see pg.26).

This special product, to be inserted into the tag holder housing of terminal blocks and end brackets of the BT/DIN/PO-BT/3-BTU types, permits perfect positioning of the tag itself.



TIM02

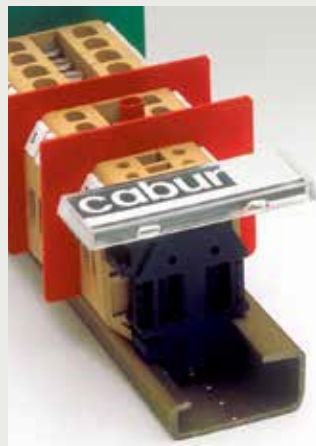

TIM02



PTMS



PTM

CODE	ID CODE	DESCRIPTION	PIECES PK.
TIM02	TIM02	tag for identification of groups of terminal blocks for use with TA5015W / Y	10
PTMS	PTMS	40x7mm tag holder for rail to be used with TA407AW	36
PTM	PTM	40x16mm tag holder for rail to be used with TA1640AW	15

Strips for rails and adhesive strips

Strips for rails are created for identification of energy distribution boards with a length of 105 mm, corresponding to 6 DIN modules (17.5 mm).

Each card consists of 5 strips (30 DIN modules) and is special because it is pre-notched in the part underneath the individual cards (17.5 mm), so that the user can create individual 17.5 mm tags or multiples.

Available in white and yellow.

Can be printed with CaburJet.

- Material: 1.6 mm self-extinguishing polycarbonate (halogen-free)
- Self-extinguishing: UL 94-V0
- Working temperature: -40° / +80°
- Rub resistance: CEI 16-7.
- Ageing and UV resistance: conformant with UNI EN ISO4892-1-2
- Adhesive: 3M468 (when indicated)

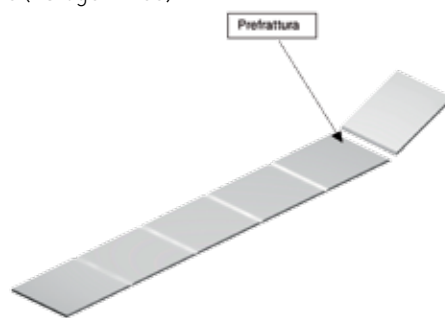
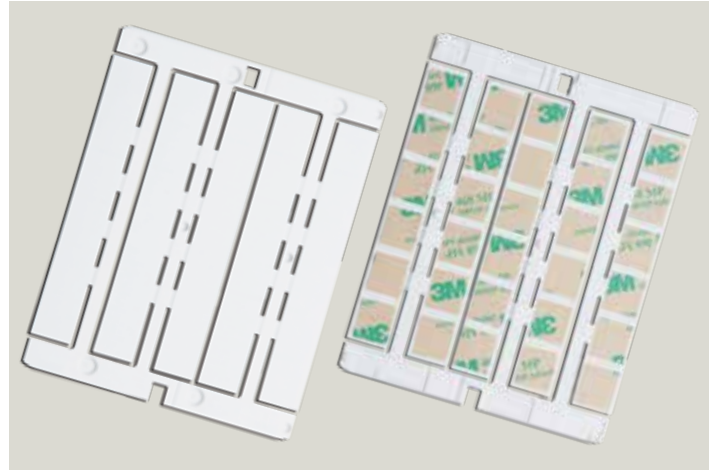

Detail of the lower surface of the strip.

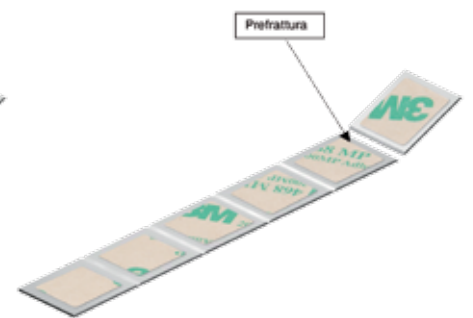

Detail of the lower surface of the adhesive strip.

CODE	ID CODE	DESCRIPTION	SIZE IN mm		COLOUR	PIECES PK.
			LENGTH	HEIGHT		
ST105W	ST105W	modular strip for rail BIN043015 - BIN100015	105	15	white	75
ST105Y	ST105Y	modular strip for rail BIN043015 - BIN100015	105	15	yellow	75
ST105AW	ST105AW	modular adhesive strip	105	15	white	75
ST105AY*	ST105Y	modular adhesive strip	105	15	yellow	75

*Available in October 2012

Rails

Rails in rigid, black PVC with adhesive for tags and strips.
Available in 430 mm (24 DIN modules) 650 mm and 1,000 mm.



CODE	ID CODE	DESCRIPTION	PIECES PK.
BIN043015	BIN043015	adhesive rail for tags and strips 430 mm height 15 mm	30
CBIN043015	CBIN043015	cover for BIN043015 height 15 mm	30
BIN100015	BIN100015	adhesive rail for tags and strips 1,000 mm height 15 mm	30
CBIN100015	CBIN100015	cover for BIN100015 height 15 mm	30

Identification tags for panel

Tags consisting of two parts in polycarbonate, which are superimposed by hooking them together. The tag part, available in white or yellow, can be printed with CaburJet. Using MarKing Pro, it is possible to insert information, logos, and symbols with print characters. The transparent part makes it easy to protect the writing.

- Material: 1.6mm self-extinguishing polycarbonate (halogen-free)
- Self-extinguishing: UL 94-V0
- Working temperature: -40° / +80°
- Rub resistance: CEI 16-7.
- Ageing and UV resistance: conformant with UNI EN ISO4892-1-2

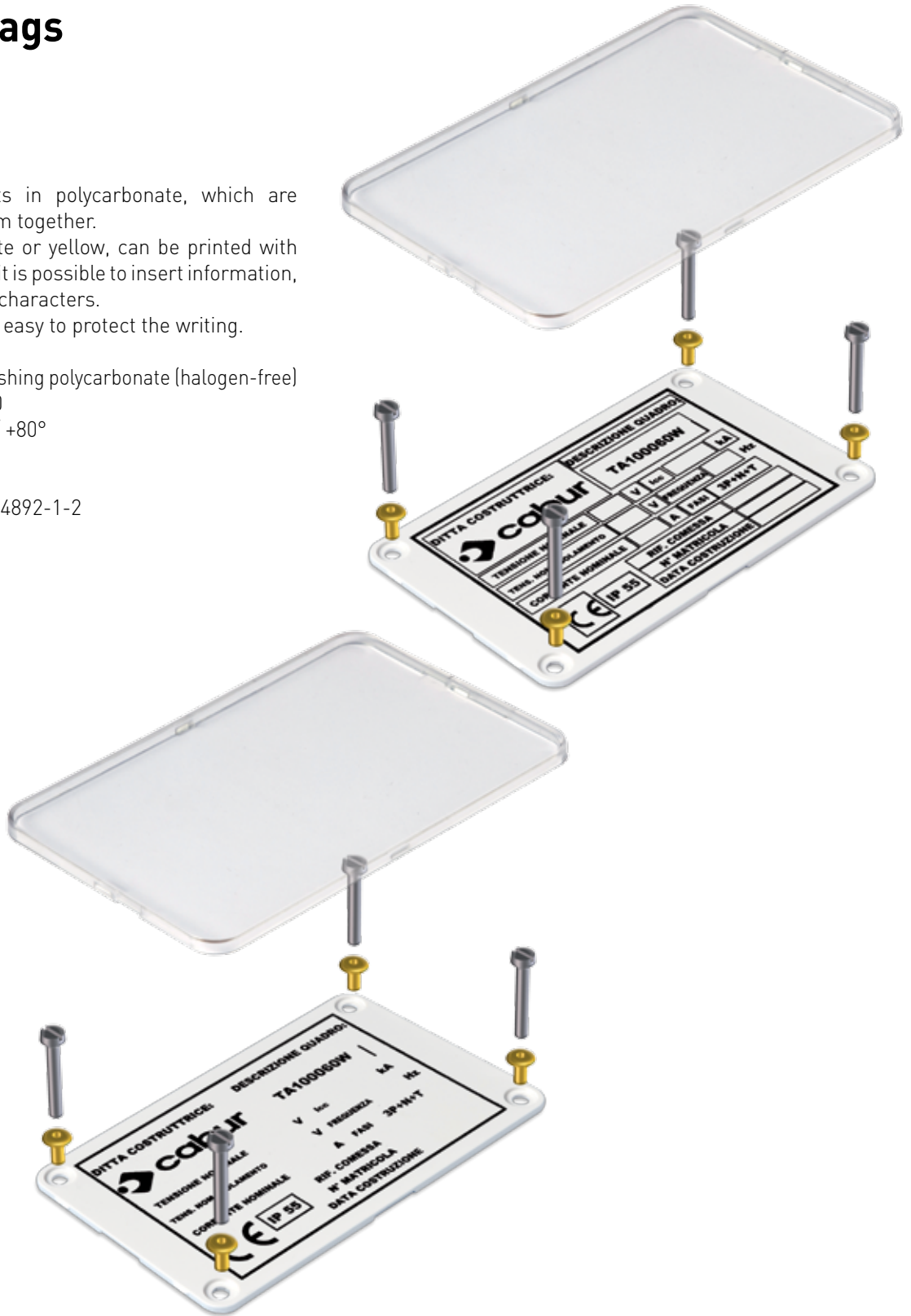

CODE	ID CODE	DESCRIPTION	PIECES PK.
TA100060	TA100060	100 x 60 mm panel identification tag	10
TA100060Y	TA100060Y	100 x 60 mm panel identification tag, yellow	10
TA100090	TA100090	100 x 90 mm panel identification tag	10
TA100090Y	TA100090Y	100 x 90 mm panel identification tag, yellow	10
VET100060	VET100060	100 x 60 mm protective clear cover for panel identification tag	10
VET100090	VET100090	100 x 90 mm protective clear cover for panel identification tag	10

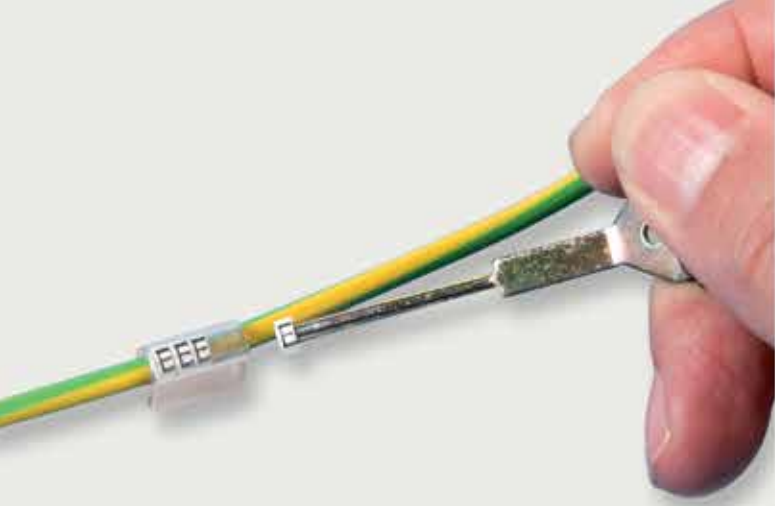

Manual numbering

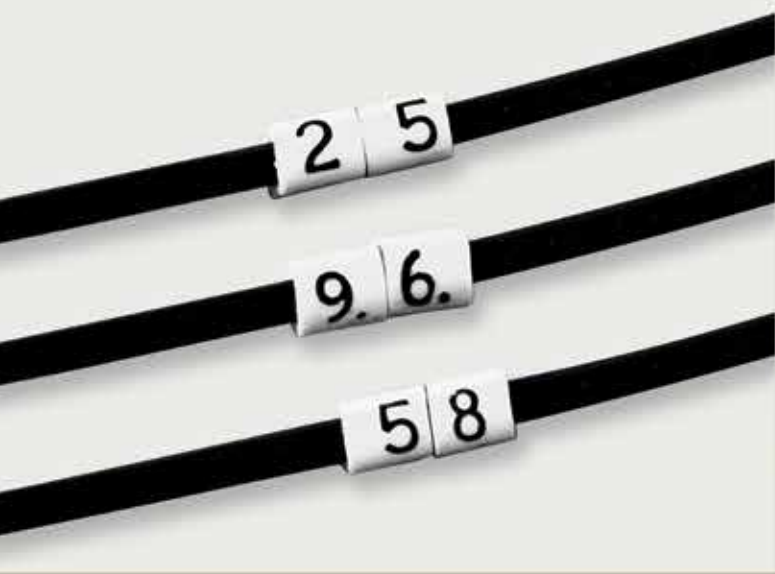

Manual numbering for wire identification	pg. 32
Transparent sleeves	pg. 33
Accessories for manual numbering	pg. 33
Shaped rings	pg. 34
Linked rings	pg. 35
Manual numbering for Cabur CSC Series terminal blocks	pg. 36
Identification tag	pg. 37
Pens for CB/CTL writing	pg. 37

Manual numbering for wire identification

Strips or sticks, 3 mm wide, for manual number of wires. Each stick contains 16 elements, placed horizontally.

- Material: PVC (polyvinyl chloride)
- Self-extinguishing: UL94-V0
- Temperature -30° / +80°

For use with TUB Series sleeves (see pg. 18)



CODE	ID CODE	DESCRIPTION	SIZE IN mm	CHARACTER NUMBER	BACK-GROUND COLOUR	CHARACTER COLOUR	CHARACTERS NUMBER PER STRIP	STRIPS PER PK.	PIECES PER PK.
MAN0W	MAN0W	strip no. 0	4x3	0	white	black	16	75	1,200
MAN1W	MAN1W	strip no. 1	4x3	1	white	black	16	75	1,200
MAN2W	MAN2W	strip no. 2	4x3	2	white	black	16	75	1,200
MAN3W	MAN3W	strip no. 3	4x3	3	white	black	16	75	1,200
MAN4W	MAN4W	strip no. 4	4x3	4	white	black	16	75	1,200
MAN5W	MAN5W	strip no. 5	4x3	5	white	black	16	75	1,200
MAN6W	MAN6W	strip no. 6	4x3	6	white	black	16	75	1,200
MAN7W	MAN7W	strip no. 7	4x3	7	white	black	16	75	1,200
MAN8W	MAN8W	strip no. 8	4x3	8	white	black	16	75	1,200
MAN9W	MAN9W	strip no. 9	4x3	9	white	black	16	75	1,200
MANAW	MANAW	strip A	4x3	A	white	black	16	75	1,200
MANBW	MANBW	strip B	4x3	B	white	black	16	75	1,200
MANCW	MANCW	strip C	4x3	C	white	black	16	75	1,200
MANDW	MANDW	strip D	4x3	D	white	black	16	75	1,200
MANEW	MANEW	strip E	4x3	E	white	black	16	75	1,200
MANFW	MANFW	strip F	4x3	F	white	black	16	75	1,200
MANGW	MANGW	strip G	4x3	G	white	black	16	75	1,200
MANHW	MANHW	strip H	4x3	H	white	black	16	75	1,200
MANIW	MANIW	strip I	4x3	I	white	black	16	75	1,200
MANJW	MANJW	strip J	4x3	J	white	black	16	75	1,200
MANKW	MANKW	strip K	4x3	K	white	black	16	75	1,200
MANLW	MANLW	strip L	4x3	L	white	black	16	75	1,200
MANMW	MANMW	strip M	4x3	M	white	black	16	75	1,200
MANNW	MANNW	strip N	4x3	N	white	black	16	75	1,200
MANOW	MANOW	strip O	4x3	O	white	black	16	75	1,200
MANPW	MANPW	strip P	4x3	P	white	black	16	75	1,200
MANQW	MANQW	strip Q	4x3	Q	white	black	16	75	1,200
MANRW	MANRW	strip R	4x3	R	white	black	16	75	1,200
MANSW	MANSW	strip S	4x3	S	white	black	16	75	1,200
MANTW	MANTW	strip T	4x3	T	white	black	16	75	1,200
MANUW	MANUW	strip U	4x3	U	white	black	16	75	1,200
MANVW	MANVW	strip V	4x3	V	white	black	16	75	1,200
MANWW	MANWW	strip W	4x3	W	white	black	16	75	1,200
MANXW	MANXW	strip X	4x3	X	white	black	16	75	1,200
MANYW	MANYW	strip Y	4x3	Y	white	black	16	75	1,200
MANZW	MANZW	strip Z	4x3	Z	white	black	16	75	1,200
MAN10W	MAN10W	strip +	4x3	+	white	black	16	75	1,200
MAN11W	MAN11W	strip -	4x3	-	white	black	16	75	1,200
MAN12W	MAN12W	strip ⊕	4x3	⊕	white	black	16	75	1,200
MAN13W	MAN13W	strip /	4x3	/	white	black	16	75	1,200
MAN14W	MAN14W	strip .	4x3	.	white	black	16	75	1,200
MAN15W	MAN15W	strip :	4x3	:	white	black	16	75	1,200
MAN16W	MAN16W	strip =	4x3	=	white	black	16	75	1,200

Transparent sleeves

PVC sleeves, available lengths 12 - 15 - 18 - 23 mm, to be used with NUT series tags, 12 - 15 - 18 - 23. Transparent. Appropriate for identification of wires from a minimum of 0.14 mm² up to a maximum of 35 mm².

- Material: PVC (polyvinyl chloride)
- Self-extinguishing: UL94-V0
- Working temperature: -40° / +80°

Please see page 18 for more details.



TUB12



TUB15



TUB18



TUB23

Accessories for manual numbering



CAB15MM



CAB30MM



CABUNC



CABDIS



CABDIS1

CODE	ID CODE	DESCRIPTION	LENGTH	CHARACTER NUMBER	PIECES PK.
CAB15MM	AB15MM	insertion device, 5 characters max	15	5	1
CAB30MM	CAB30MM	insertion device, 10 characters max	30	10	1
CABUNC	CABUNC	device to change numbering selection	30	10	1
CABDIS	CABDIS	distributor with 25 strips	36	-	1
CABDIS1	CABDIS1	distributor 25 strips	19	-	1

Shaped rings

To mark wires with a single character

Makes it possible to identify a wire by combining the various available characters.

- Material: PVC
- Markers available in yellow with characters printed in black.
- Wire cross-sections for identification: from 0.2 to 70 mm²



LETTERS AND SYMBOLS

A to Z	+	-	=	.	*	/
	PLUS	MINUS	EQUALS	FULL STOP	AST	SLASH
0 to 9						

1,000 piece roll for conductors with 2.0 mm external diameter

ID30215..

TO BE COMPLETED WITH LETTERS
OR SYMBOLS AS IN THE TABLE



**1,000 piece roll for conductors with 2.5-5 mm external diameters
wire section 2.5 - 4 mm²**

ID31540..

TO BE COMPLETED WITH LETTERS
OR SYMBOLS AS IN THE TABLE



**250 piece pk for conductors with 4-10 mm external diameters
wire section 2.5 - 16 mm²**

ID325160..

TO BE COMPLETED WITH LETTERS
OR SYMBOLS AS IN THE TABLE



**100 piece sachet for conductors with 8-16 mm external diameters
wire section 16 - 70 mm²**

ID3160700..

TO BE COMPLETED WITH LETTERS
OR SYMBOLS AS IN THE TABLE



Linked rings

Polyvinyl chloride rings, highly elastic, semi-cut.
Makes it possible to identify a cable by combining the various available characters.

Colours: black characters on white background.



LETTERS AND SYMBOLS						
A to Z	+	-	=	.	*	/
	PLUS	MINUS	EQUALS	FULL STOP	AST	SLASH
0 to 9						

1,000 piece roll for conductors with 0.8 mm external diameter

IDAC..	TO BE COMPLETED WITH LETTERS OR SYMBOLS AS IN THE TABLE	W08
---------------	---	------------

1,000 piece roll for conductors with 1.5 mm external diameter

IDAC..	TO BE COMPLETED WITH LETTERS OR SYMBOLS AS IN THE TABLE	W15
---------------	---	------------

1,000 piece roll for conductors with 2.0 mm external diameter

IDAC..	TO BE COMPLETED WITH LETTERS OR SYMBOLS AS IN THE TABLE	W20
---------------	---	------------

1,000 piece roll for conductors with 2.5 mm external diameter

IDAC..	TO BE COMPLETED WITH LETTERS OR SYMBOLS AS IN THE TABLE	W25
---------------	---	------------

1,000 piece roll for conductors with 3.0 mm external diameter

IDAC..	TO BE COMPLETED WITH LETTERS OR SYMBOLS AS IN THE TABLE	W30
---------------	---	------------

500 piece roll for conductors with 3.5 mm external diameter

IDAC..	TO BE COMPLETED WITH LETTERS OR SYMBOLS AS IN THE TABLE	W35
---------------	---	------------

500 piece roll for conductors with 4.5 mm external diameter

IDAC..	TO BE COMPLETED WITH LETTERS OR SYMBOLS AS IN THE TABLE	W45
---------------	---	------------

500 piece roll for conductors with 6.0 mm external diameter

IDAC..	TO BE COMPLETED WITH LETTERS OR SYMBOLS AS IN THE TABLE	W60
---------------	---	------------

Manual numbering for Cabur CSC Series Terminal Blocks

"Straddle" type tags, quick connect, which make it possible to create identification codes, including alphanumeric codes for circuits.

The tags insert directly into polyamide terminal blocks. Melamine terminal blocks require special adaptors.

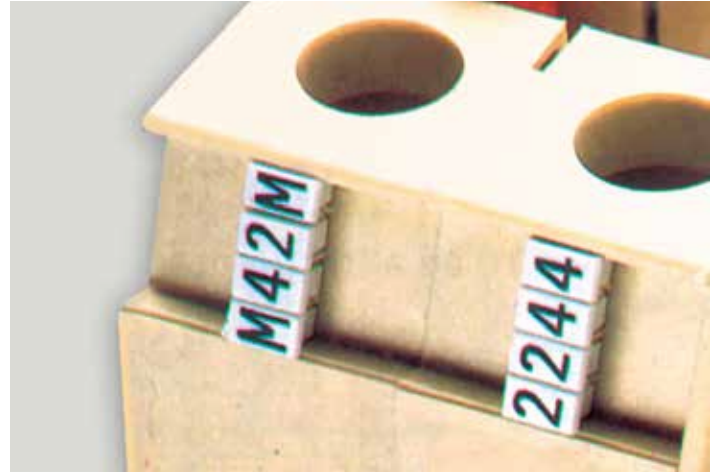

ADR/2 2 positions code ADR02

ADR/4 4 positions code ADR04

ADR/6 6 positions code ADR06

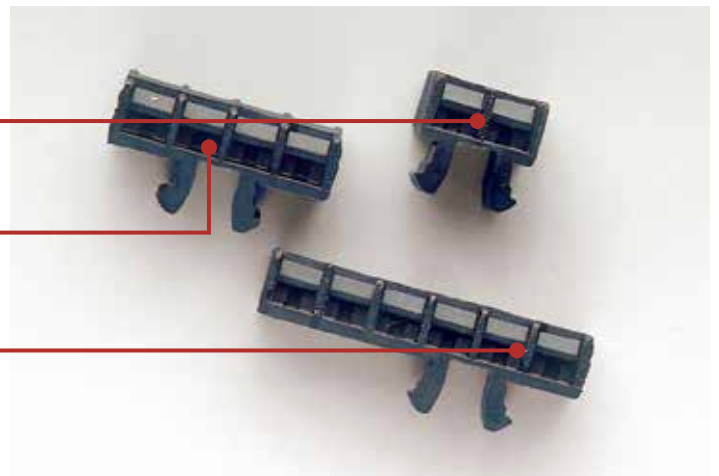

CODE	ID CODE TABLE (100 elements)	MARKING	CODE	ID CODE TABLE (100 elements)	MARKING	CODE	ID CODE TABLE (100 elements)	MARKING
CSC00	CSC	blank	CSMMM	CSC/MM	M	CS00L	CSC/ll	l
CS000	CSC/00	0	CSNNN	CSC/NN	N	CS00M	CSC/mm	m
CS111	CSC/11	1	CSPPP	CSC/PP	P	CS00N	CSC/nn	n
CS222	CSC/22	2	CSQQQ	CSC/QQ	Q	CS00O	CSC/oo	o
CS333	CSC/33	3	CSRRR	CSC/RR	R	CS00P	CSC/pp	p
CS444	CSC/44	4	CSSSS	CSC/SS	S	CS00Q	CSC/qq	q
CS555	CSC/55	5	CSTTT	CSC/TT	T	CS00R	CSC/rr	r
CS666	CSC/66	6	CSUUU	CSC/UU	U	CS00S	CSC/ss	s
CS777	CSC/77	7	CSVVV	CSC/VV	V	CS00T	CSC/tt	t
CS888	CSC/88	8	CSWWW	CSC/WW	W	CS00U	CSC/uu	u
CS999	CSC/99	9	CSXXX	CSC/XX	X	CS00V	CSC/vv	v
CSC09	CSC/09	0-1-2-3-4-5-6-7-8-9	CSYYY	CSC/YY	Y	CS00W	CSC/ww	w
CSAAA	CSC/AA	A	CSZZZ	CSC/ZZ	Z	CS00X	CSC/xx	x
CSBBB	CSC/BB	B	CS00A	CSC/aa	a	CS00Y	CSC/yy	y
CSCCC	CSC/CC	C	CS00B	CSC/bb	b	CS00Z	CSC/zz	z
CSDDD	CSC/DD	D	CS00C	CSC/cc	c	CS0G1	CSC/G1	=
CSEEE	CSC/EE	E	CS00D	CSC/dd	d	CS0G2	CSC/G2	+
CSFFF	CSC/FF	F	CS00E	CSC/ee	e	CS0G3	CSC/G3	-
CSGGG	CSC/GG	G	CS00F	CSC/ff	f	CS0G4	CSC/G4	~
CSHHH	CSC/HH	H	CS00G	CSC/gg	g	CS0G5	CSC/G5	
CSIII	CSC/II	I	CS00H	CSC/hh	h	CS0G6	CSC/G6	
CSJJJ	CSC/JJ	J	CS00I	CSC/ii	i	CS0G7	CSC/G7	÷
CSKKK	CSC/KK	K	CS00J	CSC/jj	j	CS0G8	CSC/G8	/
CSLLL	CSC/LL	L	CS00K	CSC/kk	k	CS0G9	CSC/G9	[

- Closed end slices
- Wire terminals, pre-insulated with PVC
- Crimper
- Screwdrivers
- Insulated screwdrivers for voltage up to 1,000 V
- Braided sheath
- Heat shrink sleeve

Identifying tag

- Material: white PVC
- Bilingual Italian - English
- Appropriate for identification of wire bundles.



CODE	ID CODE	DESCRIPTION	SIZE IN mm		PIECES PK.
			LENGTH	WIDTH	
IDEN01	IDEN01	identification tag for wire bundles	100	40	100

Pens for CB/CTL writing

Thin, water-resistant, available in black and red, these are appropriate for marking tags that are not marked, including IDEN01-type identifying tags.



CODE	ID CODE	DESCRIPTION	PIECES PK.
CT004	CB/CTL/NERO	black pen	12
CT006	CB/CTL/ROSSO	red pen	12



Wiring accessories

Closed end slices.....	pg. 40
Wire terminals, pre-insulated with PVC.....	pg. 41
Crimper.....	pg. 43
Screwdrivers.....	pg. 44
Insulated screwdrivers for voltage up to 1,000 V.....	pg. 44
Braided sheath.....	pg. 45
Heat-shrink sleeve.....	pg. 47

Closed end slices

Ends with sleeves and insulated collars

Series: WP

To block wires, a complete line of ends with sleeves, single slot.
Tin-plated electrolytic copper sleeve, insulated with polypropylene.

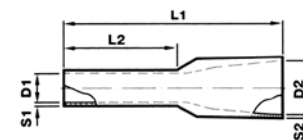

CODE	ID CODE	DESCRIPTION	COLOUR	SECTION	D1	D2	L1	L2	S1	S2	PIECES PK.
				(mm ²)	(mm)	(mm)	(mm)	(mm)	(mm)	(mm)	
WP30002	WP5-14	t. blocks 0.5-14 x 8	White	0.5	1	2.6	14	8	0.15	0.25	500
WP30003	WP5-16	t. blocks 0.5-16 x 10	White	0.5	1	2.6	16	10	0.15	0.25	500
WP30005	WP75-14	t. blocks 0.75-14 x 8	Grey	0.75	1.2	2.8	14	8	0.15	0.25	500
WP30006	WP75-16	t. blocks 0.75-16 x 10	Grey	0.75	1.2	2.8	16	10	0.15	0.25	500
WP30009	WP1-14	t. blocks 1-14 x 8	Red	1	1.4	3	14	8	0.15	0.25	500
WP30010	WP1-18	t. blocks 1-18 x 12	Red	1	1.4	3	18	12	0.15	0.25	500
WP30013	WP15-14	t. blocks 1.5-14 x 8	Black	1.5	1.7	3.5	14	8	0.15	0.25	500
WP30014	WP15-18	t. blocks 1.5-18 x 12	Black	1.5	1.7	3.5	18	12	0.15	0.25	500
WP30016	WP25-14	t. blocks 2.5-14 x 8	Blue	2.5	2.2	4.2	15	8	0.15	0.25	500
WP30017	WP25-19	t. blocks 2.5-19 x 12	Blue	2.5	2.2	4.2	19	12	0.15	0.25	500
WP30019	WP40-16	t. blocks 4.0-16 x 8	Grey	4	2.8	4.8	16	8	0.2	0.3	500
WP30020	WP40-20	t. blocks 4.0-20 x 12	Grey	4	2.8	4.8	20	12	0.2	0.3	500
WP30022	WP60-20	t. blocks 6.0-20 x 12	Yellow	6	3.5	6.3	20	12	0.2	0.3	100
WP30023	WP60-26	t. blocks 6.0-26 x 18	Yellow	6	3.5	6.3	26	18	0.2	0.3	100
WP30024	WP100-21	t. blocks 10-22 x 12	Red	10	4.5	7.6	22	12	0.2	0.4	100
WP30025	WP100-28	t. blocks 100-28 x 18	Red	10	4.5	7.6	28	18	0.2	0.4	100
WP30026	WP160-22	t. blocks 16-22 x 12	Blue	16	5.8	8.8	22	12	0.2	0.4	100
WP30027	WP160-28	t. blocks 160-28 x 18	Blue	16	5.8	8.8	28	18	0.2	0.4	100
WP30028	WP250-29	t. blocks 25-30 x 16	Yellow	25	7.3	11.2	30	16	0.2	0.4	50
WP30029	WP250-32	t. blocks 250-36 x 22	Yellow	25	7.3	11.2	36	22	0.2	0.4	50
WP30030	WP350-30	t. blocks 35-30 x 16	Red	35	8.3	12.7	30	16	0.2	0.4	50
WP30031	WP350-41	t. blocks 350-39 x 25	Red	35	8.3	12.7	39	25	0.2	0.4	50
WP30032	WP500-40	t. blocks 50-36 x 20	Blue	50	10.3	15	36	20	0.3	0.5	50
WP30033	WP500-41	t. blocks 500-41 x 25	Blue	50	10.3	15	41	25	0.3	0.5	50

Ends with sleeves and insulated collars

Series: WP

The double slot series is made of tin-plated electrolytic copper with the insulated part in polypropylene, resistant up to 105°C.

These ends were designed for use in connections where a safe and fast derivation is required. In fact, the current trend towards miniaturisation of electrical equipment makes these ends useful and economical.

The special large housing slot is easily able to hold the bulk created by two wires.

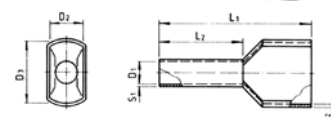

CODE	ID CODE	COLOUR	SECTION	D1	D2	D3	L1	L2	S1	S2	PIECES PK.
			(mm ²)	(mm)	(mm)	(mm)	(mm)	(mm)	(mm)	(mm)	
WP90001	WPD05/15	white	2.0 x 0.5	1,1.5	2.5	4.7	15.7	8.7	0.15	0.3	500
WP90002	WPD75/15	grey	2.0 x 0.75	1.8	2.8	5.0	15.5	8.9	0.15	0.3	500
WP90003	WPD01/15	red	2.0 x 1.0	2.3	3.2	5.5	15.8	8.0	0.15	0.3	500
WP90004	WPD15/16	black	2.0 x 1.5	2.3	3.5	6.5	16.0	8.0	0.15	0.3	500
WP90005	WPD25/18	blue	2.0 x 2.5	2.9	4.3	7.5	18.3	10.0	0.20	0.4	500
WP90006	WPD04/23	grey	2.0 x 4.0	3.8	4.9	8.8	23.3	12.5	0.20	0.4	100
WP90007	WPD06	yellow	2.0 x 6.0	-	-	-	-	12	-	-	100
WP90008	WPD10	red	2.0 x 10	-	-	-	-	14	-	-	100

Ends with uninsulated sleeves

Made of tin-plated electrolytic copper.



CODE	ID CODE	DESCRIPTION	CROSS-SECTION	LENGTH	PIECES PK.
WPN10508	WPN0508	uninsulated terminal block 0.5-8	0.5	8	1000
WPN10758	WPN0758	uninsulated terminal block 0.75-8	0.75	8	1000
WPN11010	WPN1010	uninsulated terminal block 1-10	1	10	1000
WPN11510	WPN1510	uninsulated terminal block 1.5-10	1.5	10	1000
WPN12510	WPN2510	uninsulated terminal block 2.5-10	2.5	10	1,000*
WPN14012	WPN4012	uninsulated terminal block 4.0-12	4	12	1000**
WPN16012	WPN6012	uninsulated terminal block 6.0-12	6	12	500
WPN11015	WPN10015	uninsulated terminal block 10-15	10	15	500
WPN11615	WPN16015	uninsulated terminal block 16-15	16	15	500
WPN12515	WPN25015	uninsulated terminal block 25-15	25	15	100

* appropriate for use with Cabur CBC.2 terminal blocks

** appropriate for use with Cabur CBC.4 terminal blocks

Wire terminals, pre-insulated with PVC

Tin-plated copper eyelets, with PVC insulation

Tin-plated copper forks, with PVC insulation



Eyelets

CODE	ID CODE	TYPE	COLOUR	SECTION	PITCH
				(mm ²)	
WPO15035/R	WPO4020	eyelet	red	1.5	M3.5
WPO15040R	WPO4021	eyelet	red	1.5	M4
WPO15050/R	WPO4022	eyelet	red	1.5	M5
WPO150600/R	WPO4023	eyelet	red	1.5	M6
WPO15080/R	WPO4024	eyelet	red	1.5	M8
WPO150100/R	WPO4025	eyelet	red	1.5	M10
WPO25030/B	WPO4026	eyelet	blue	2.5	M3
WPO25035/B	WPO4027	eyelet	blue	2.5	M3.5M
WPO25040/B	WPO4028	eyelet	blue	2.5	M4
WPO25050/B	WPO4029	eyelet	blue	2.5	M5
WPO25060/B	WPO4030	eyelet	blue	2.5	M6
WPO25080/B	WPO4031	eyelet	blue	2.5	M8
WPO250100/B	WPO4032	eyelet	blue	2.5	M10
WPO40040/Y	WPO4033	eyelet	yellow	4.0	M4
WPO40050/Y	WPO4034	eyelet	yellow	4.0	M5
WPO40060/Y	WPO4035	eyelet	yellow	4.0	M6
WPO40080/Y	WPO4036	eyelet	yellow	4.0	M8
WPO4001000/Y	WPO4037	eyelet	yellow	4.0	M10
WPO400120/Y	WPO4038	eyelet	yellow	4.0	M12
WPO60040/Y	WPO4039	eyelet	yellow	6.0	M4
WPO60050/Y	WPO4040	eyelet	yellow	6.0	M5
WPO60060/Y	WPO4041	eyelet	yellow	6.0	M6
WPO60080/Y	WPO4042	eyelet	yellow	6.0	M8
WPO600100/Y	WPO4043	eyelet	yellow	6.0	M10
WPO600120/Y	WPO4044	eyelet	yellow	6.0	M12

Wire terminals, pre-insulated with PVC

Tin-plated copper eyelets, with PVC insulation
Tin-plated copper forks, with PVC insulation



Forks

CODE	ID CODE	TYPE	COLOUR	SECTION (mm ²)	PITCH
WPF15030/R	WPF5016	fork	red	1.5	M3
WPF15035/R	WPF5017	fork	red	1.5	M3.5
WPF15040/R	WPF5018	fork	red	1.5	M4
WPF15050/R	WPF5019	fork	red	1.5	M5
WPF15060/R	WPF5020	fork	red	1.5	M6
WPF25030/B	WPF5021	fork	blue	2.5	M3
WPF25035/B	WPF5022	fork	blue	2.5	M3.5
WPF25040/B	WPF5023	fork	blue	2.5	M4
WPF25050/B	WPF5024	fork	blue	2.5	M5
WPF25060/B	WPF5025	fork	blue	2.5	M6
WPF40040/Y	WPF5026	fork	yellow	4.0	M4
WPF40050/Y	WPF5027	fork	yellow	4.0	M5
WPF40060/Y	WPF5028	fork	yellow	4.0	M6
WPF40080/Y	WPF5029	fork	yellow	4.0	M8
WPF60040/Y	WPF5030	fork	yellow	6.0	M4
WPF60050/Y	WPF5031	fork	yellow	6.0	M4
WPF60060/Y	WPF5032	fork	yellow	6.0	M6
WPF60080/Y	WPF5033	fork	yellow	6.0	M8

Crimper

Tool designed for use by the installer. The matrices move parallel to each other and generate a force of 10,000 N. The entire tool is covered with a plastic body that makes it ergonomic and comfortable to use.



CODE	ID CODE	DESCRIPTION
UMCT3149	UMCT	crimper
UMCT3127 *	UMPU02510	matrix for closed end slices from 0.25 to 10 mm ²
UMCT3153 *	UMPU1625	matrix for closed end slices from 16 to 25 mm ²
UMCT3154 *	UMPU3550	matrix for closed end slices from 35 to 50 mm ²
UMCT3129	UMPI1525	matrix for eyelets and forks from 1.5 to 2.5 mm ²
UMCT3128	UMPI4060	matrix for eyelets and forks from 4 to 6 mm ²

* Matrices UMCT 3127, UMCT 3153, and UMCT 3154 can crimp 12 mm long eyelets with a single compression. For longer closed end slices, a second crimp is sufficient. (These matrices do not have a positioner and do not limit the length of the eyelet).

For crimping of contacts for Cabur Solar connectors, matrices IS3153 and IS3154 are available.

How to replace the UMTC matrix



- open the pliers as wide as possible (fig.1);
- slowly bring the two levers of the pliers together, until the locking/release mechanism makes three clicks (fig.2);
- observe the anchorage stud on the matrix (fig.2);
- insert the matrix, moving the anchorage stud towards the internal part of the pliers chamber (fig.3);
- make sure that the plastic tooth has locked the matrix in place or that it has risen (fig.4);
- press the two levers of the pliers, closing them as tightly as possible (fig.4);
- release the handles; the pliers should open automatically and completely (fig.5);
- while closing the pliers, if you notice that the crimping has been unsuccessful or the pliers become blocked for any reason, you can release them by pressing and releasing the handles and simultaneously activating the release lever located inside the handle, using your thumb (fig.6).

Screwdrivers

Screwdrivers to activate springs - terminal blocks Series: H

The ergonomic handle guarantees comfort for the entire duration of the work. In addition, each handle has a transparent anti-slip rubber insert, which ensures a good hold over the tool.

CODE	ID CODE	BLADE	LENGTH
CCH02	CCH/2,5-4	0.5 x 3 x 80 mm	160 mm
CCH06	CCH/6	1 x 5.5 x 125 mm	220 mm



CCH/2,5-4



CCH/6

Insulated screwdrivers for voltage up to 1,000 V

The ergonomic handle guarantees comfort for the entire duration of the work. In addition, each handle has a transparent anti-slip rubber insert, which ensures a good hold over the tool.

CODE	ID CODE	BLADE	LENGTH
CCV03	CCV/2,5	0.4 x 2.5 x 75 mm	160 mm
CCV04	CCV/4	0.8 x 4 x 100 mm	195 mm
CCV05	CCV/5	1 x 5.5 x 125 mm	220 mm



CCV/2,5



CCV/4



CCV/5

Braided sheath

For protection of wires or wire bundles.

Sleeve, made of extruded single wire with polyester incorporated.

- For installation and maintenance
- For insulation, wiring, protection
- For home, auto, industrial, and nautical use
- Working temperature: from -55°C to +130°C
- Melting point: +255°C
- Self-extinguishing: UL94-V2
- Colours: Grey-Black

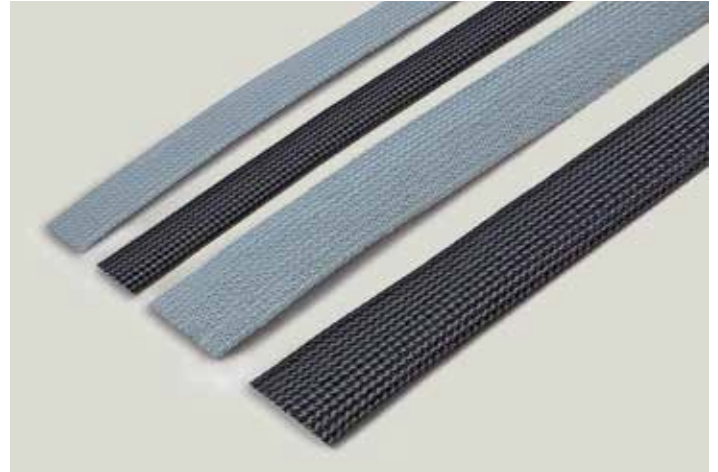

CODE	ID CODE	DESCRIPTION	COLOUR	NOMINAL DIAMETER	MT PK.
CT03100G	CT03100G	braided sheath HB94 2÷6	grey	3 mm	100
CT06100G	CT06100G	braided sheath HB94 5÷12	grey	6 mm	100
CT08100G	CT08100G	braided sheath HB94 6÷14	grey	8 mm	100
CT10100G	CT10100G	braided sheath HB94 8÷18	grey	10 mm	100
CT12050G	CT12050G	braided sheath HB94 10÷21	grey	12 mm	50
CT15050G	CT15050G	braided sheath HB94 13÷25	grey	15 mm	50
CT20025G	CT20025G	braided sheath HB94 18÷29	grey	20 mm	25
CT25025G	CT25025G	braided sheath HB94 22÷36	grey	25 mm	25
CT30025G	CT30025G	braided sheath HB94 27÷45	grey	30 mm	25
CT40025G	CT40025G	braided sheath HB94 35÷55	grey	40 mm	25
CT05025G	CT05025G	braided sheath HB94 45÷65	grey	50 mm	25
CT03100B	CT03100B	braided sheath HB94 2÷6	black	3 mm	100
CT06100B	CT06100B	braided sheath HB94 5÷12	black	6 mm	100
CT08100B	CT08100B	braided sheath HB94 6÷14	black	8 mm	100
CT10100B	CT10100B	braided sheath HB94 8÷18	black	10 mm	100
CT12050B	CT12050B	braided sheath HB94 10÷21	black	12 mm	50
CT15050B	CT15050B	braided sheath HB94 13÷25	black	15 mm	50
CT20025B	CT20025B	braided sheath HB94 18÷29	black	20 mm	25
CT25025B	CT25025B	braided sheath HB94 22÷36	black	25 mm	25
CT30025B	CT30025B	braided sheath HB94 27÷45	black	30 mm	25
CT40025B	CT40025B	braided sheath HB94 35÷55	black	40 mm	25
CT05025B	CT05025B	braided sheath HB94 45÷65	black	50 mm	25
CT40025B	CT40025B	braided sheath HB94 35÷55	black	40 mm	25
CT05025B	CT05025B	braided sheath HB94 45÷65	black	50 mm	25

Braided sheath

For protection of wires or wire bundles.

Sleeve, made of extruded single wire with polyester incorporated.

- For installation and maintenance
- For insulation, wiring, protection
- For home, auto, industrial, and nautical use
- Working temperature: from -55°C to +130°C
- Melting point: +255°C
- Self-extinguishing: UL94-V2
- Colours: Grey-Black



CODE	ID CODE	DESCRIPTION	COLOUR	NOMINAL DIAMETER	MT PK.
CTB06015G	CTB06015G	minibox braided sheath	grey	6 mm	15
CTB10015G	CTB10015G	minibox braided sheath	grey	10 mm	15
CTB12015G	CTB12015G	minibox braided sheath	grey	12 mm	15
CTB15050G	CTB15050G	minibox braided sheath	grey	15 mm	15
CTB20010G	CTB20010G	minibox braided sheath	grey	20 mm	10
CTB25010G	CTB25010G	minibox braided sheath	grey	25 mm	10
CTB30005G	CTB30005G	minibox braided sheath	grey	30 mm	5
CTB40005G	CTB40005G	minibox braided sheath	grey	40 mm	5
CTB05005G	CTB05005G	minibox braided sheath	grey	50 mm	5
CTB06015B	CTB06015B	minibox braided sheath	black	6 mm	15
CTB10015B	CTB10015B	minibox braided sheath	black	10 mm	15
CTB12015B	CTB12015B	minibox braided sheath	black	12 mm	15
CTB15050B	CTB15050B	minibox braided sheath	black	15 mm	15
CTB20010B	CTB20010B	minibox braided sheath	black	20 mm	10
CTB25010B	CTB25010B	minibox braided sheath	black	25 mm	10
CTB30005B	CTB30005B	minibox braided sheath	black	30 mm	5
CTB40005B	CTB40005B	minibox braided sheath	black	40 mm	5
CTB05005B	CTB05005B	minibox braided sheath	black	50 mm	5

Heat-shrink sleeve

To combine, cover, and protect conductors, ends, and components.

The shrinking operation is achieved with a temperature of over 70 degrees, obtained with a hot-air dryer or an indirect flame. The sleeves adhere perfectly to the object(s) that need to be covered, united, or protected.

- For insulation, wiring, protection
- For home, auto, industrial, and nautical use
- Working temperature: -55°C to +125°C
- Shrink temperature: +70°C
- Shrink ratio: 2:1



CODE	ID CODE	DESCRIPTION	COLOUR	CROSS-SECTION	MT PK.
GTE012200B	GTE012200B	polyolefin econ self-ext UL 2:1 125°	black	1.2 mm ²	150
GTE016200B	GTE016200B	polyolefin econ self-ext UL 2:1 125°	black	1.6 mm ²	150
GTE024200B	GTE024200B	polyolefin econ self-ext UL 2:1 125°	black	2.4 mm ²	150
GTE032200B	GTE032200B	polyolefin econ self-ext UL 2:1 125°	black	3.2 mm ²	150
GTE048100B	GTE048100B	polyolefin econ self-ext UL 2:1 125°	black	4.8 mm ²	75
GTE064100B	GTE064100B	polyolefin econ self-ext UL 2:1 125°	black	6.4 mm ²	75
GTE095100B	GTE095100B	polyolefin econ self-ext UL 2:1 125°	black	9.5 mm ²	75
GTE127100B	GTE127100B	polyolefin econ self-ext UL 2:1 125°	black	12.7 mm ²	50
GTE190100B	GTE190100B	polyolefin econ self-ext UL 2:1 125°	black	19 mm ²	30
GTE254050B	GTE254050B	polyolefin econ self-ext UL 2:1 125°	black	25.4 mm ²	30
GTE381050B	GTE381050B	polyolefin econ self-ext UL 2:1 125°	black	38.1 mm ²	30
GTE508050B	GTE508050B	polyolefin econ self-ext UL 2:1 125°	black	50.8 mm ²	30
GTF012150B	GTF012150B	polyolefin flex self-ext UL 2:1 125°	black	1.2 mm ²	150
GTF016150B	GTF016150B	polyolefin flex self-ext UL 2:1 125°	black	1.6 mm ²	150
GTF024150B	GTF024150B	polyolefin flex self-ext UL 2:1 125°	black	2.4 mm ²	150
GTF032150B	GTF032150B	polyolefin flex self-ext UL 2:1 125°	black	3.2 mm ²	150
GTF048075B	GTF048075B	polyolefin flex self-ext UL 2:1 125°	black	4.8 mm ²	75
GTF064075B	GTF064075B	polyolefin flex self-ext UL 2:1 125°	black	6.4 mm ²	75
GTF095075B	GTF095075B	polyolefin flex self-ext UL 2:1 125°	black	9.5 mm ²	75
GTF127050B	GTF127050B	polyolefin flex self-ext UL 2:1 125°	black	12.7 mm ²	50
GTF190030B	GTF190030B	polyolefin flex self-ext UL 2:1 125°	black	19 mm ²	30
GTF254030B	GTF254030B	polyolefin flex self-ext UL 2:1 125°	black	25.4 mm ²	30
GTF381030B	GTF381030B	polyolefin flex self-ext UL 2:1 125°	black	38.1 mm ²	30
GTF508030B	GTF508030B	polyolefin flex self-ext UL 2:1 125°	black	50.8 mm ²	30
GTF762015B	GTF762015B	polyolefin flex self-ext UL 2:1 125°	black	76.2 mm ²	15
GTF101615B	GTF101615B	polyolefin flex self-ext UL 2:1 125°	black	101.6 mm ²	15
GTF012150W	GTF012150W	polyolefin flex self-ext UL 2:1 125°	white	1.2 mm ²	150
GTF016150W	GTF016150W	polyolefin flex self-ext UL 2:1 125°	white	1.6 mm ²	150
GTF024150W	GTF024150W	polyolefin flex self-ext UL 2:1 125°	white	2.4 mm ²	150
GTF032150W	GTF032150W	polyolefin flex self-ext UL 2:1 125°	white	3.2 mm ²	150
GTF048075W	GTF048075W	polyolefin flex self-ext UL 2:1 125°	white	4.8 mm ²	75
GTF064075W	GTF064075W	polyolefin flex self-ext UL 2:1 125°	white	6.4 mm ²	75
GTF095075W	GTF095075W	polyolefin flex self-ext UL 2:1 125°	white	9.5 mm ²	75

Heat-shrink sleeve

To combine, cover, and protect conductors, ends, and components.

The shrinking operation is achieved with a temperature of over 70 degrees, obtained with a hot-air dryer or an indirect flame. The sleeves adhere perfectly to the object(s) that need to be covered, united, or protected.

- For insulation, wiring, protection
- For home, auto, industrial, and nautical use
- Working temperature: -55°C to +125°C
- Shrink temperature: +70°C
- Shrink ratio: 2:1



CODE	ID CODE	DESCRIPTION	COLOUR	CROSS-SECTION	MT PK.
GTF190030W	GTF190030W	polyolefin flex self-ext UL 2:1 125°	white	19 mm ²	30
GTF254030W	GTF254030W	polyolefin flex self-ext UL 2:1 125°	white	25.4 mm ²	30
GTF381030W	GTF381030W	polyolefin flex self-ext UL 2:1 125°	white	38.1 mm ²	30
GTF508030W	GTF508030W	polyolefin flex self-ext UL 2:1 125°	white	50.8 mm ²	30
GTF012150T	GTF012150T	polyolefin flex self-ext UL 2:1 125°	transparent	1.2 mm ²	150
GTF016150T	GTF016150T	polyolefin flex self-ext UL 2:1 125°	transparent	1.6 mm ²	150
GTF024150T	GTF024150T	polyolefin flex self-ext UL 2:1 125°	transparent	2.4 mm ²	150
GTF032150T	GTF032150T	polyolefin flex self-ext UL 2:1 125°	transparent	3.2 mm ²	150
GTF048075T	GTF048075T	polyolefin flex self-ext UL 2:1 125°	transparent	4.8 mm ²	75
GTF064075T	GTF064075T	polyolefin flex self-ext UL 2:1 125°	transparent	6.4 mm ²	75
GTF095075T	GTF095075T	polyolefin flex self-ext UL 2:1 125°	transparent	9.5 mm ²	75
GTF127050T	GTF127050T	polyolefin flex self-ext UL 2:1 125°	transparent	12.7 mm ²	50
GTF190030T	GTF190030T	polyolefin flex self-ext UL 2:1 125°	transparent	19 mm ²	30
GTF254030T	GTF254030T	polyolefin flex self-ext UL 2:1 125°	transparent	25.4 mm ²	30
GTF381030T	GTF381030T	polyolefin flex self-ext UL 2:1 125°	transparent	38.1 mm ²	30
GTF508030T	GTF508030T	polyolefin flex self-ext UL 2:1 125°	transparent	50.8 mm ²	30
GTF016150GV	GTF016150GV	polyolefin self-ext UL 2:1 135°	yellow-green	1.6 mm ²	150
GTF024150GV	GTF024150GV	polyolefin self-ext UL 2:1 135°	yellow-green	2.4 mm ²	150
GTF032150GV	GTF032150GV	polyolefin self-ext UL 2:1 135°	yellow-green	3.2 mm ²	150
GTF048075GV	GTF048075GV	polyolefin self-ext UL 2:1 135°	yellow-green	4.8 mm ²	75
GTF064075GV	GTF064075GV	polyolefin self-ext UL 2:1 135°	yellow-green	6.4 mm ²	75
GTF095075GV	GTF095075GV	polyolefin self-ext UL 2:1 135°	yellow-green	9.5 mm ²	60
GTF127050GV	GTF127050GV	polyolefin self-ext UL 2:1 135°	yellow-green	12.7 mm ²	60
GTF190030GV	GTF190030GV	polyolefin self-ext UL 2:1 135°	yellow-green	19 mm ²	30
GTF254030GV	GTF254030GV	polyolefin self-ext UL 2:1 135°	yellow-green	25.4 mm ²	30
GTF381030GV	GTF381030GV	polyolefin self-ext UL 2:1 135°	yellow-green	38.1 mm ²	30
GTF508030GV	GTF508030GV	polyolefin self-ext UL 2:1 135°	yellow-green	50.8 mm ²	30
GTA030150B	GTA030150B	polyolefin-adhes. double wall self-ext UL 3:1 125°	black	3 mm ²	150
GTA048100B	GTA048100B	polyolefin-adhes. double wall self-ext UL 3:1 125°	black	4.8 mm ²	100
GTA060075B	GTA060075B	polyolefin-adhes. double wall self-ext UL 3:1 125°	black	6 mm ²	75
GTA090050B	GTA090050B	polyolefin-adhes. double wall self-ext UL 3:1 125°	black	9 mm ²	50
GTA120025B	GTA120025B	polyolefin-adhes. double wall self-ext UL 3:1 125°	black	12 mm ²	25
GTA190025B	GTA190025B	polyolefin-adhes. double wall self-ext UL 3:1 125°	black	19 mm ²	25
GTA240025B	GTA240025B	polyolefin-adhes. double wall self-ext UL 3:1 125°	black	24 mm ²	25
GTA300025B	GTA300025B	polyolefin-adhes. double wall self-ext UL 3:1 125°	black	30.0 mm ²	25
GTA400025B	GTA400025B	polyolefin-adhes. double wall self-ext UL 3:1 125°	black	40.0 mm ²	25

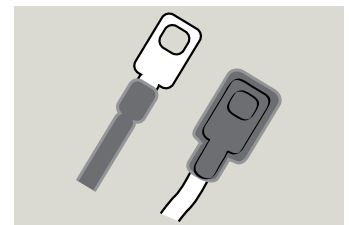
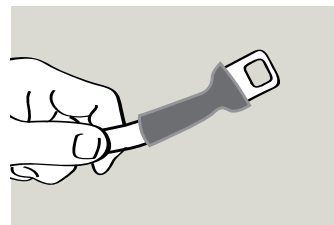
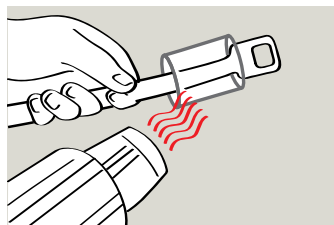
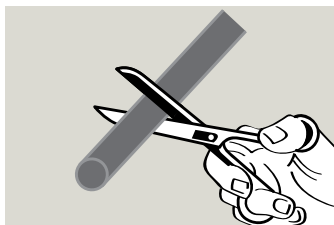

Heat-shrink sleeve

To combine, cover, and protect conductors, ends, and components.

The shrinking operation is achieved with a temperature of over 70 degrees, obtained with a hot-air dryer or an indirect flame. The sleeves adhere perfectly to the object(s) that need to be covered, united, or protected.

- For insulation, wiring, protection
- For home, auto, industrial, and nautical use
- Working temperature: -55°C to +125°C
- Shrink temperature: +70°C
- Shrink ratio: 2:1



CODE	ID CODE	DESCRIPTION	COLOUR	CROSS-SECTION	MT PK.
GTBOXB016X15	GTBOXB016X15	minibox polyolefin self-ext UL 2:1 125°	blue	1.6 mm ²	15
GTBOXB024X15	GTBOXB024X15	minibox polyolefin self-ext UL 2:1 125°	blue	2.4 mm ²	15
GTBOXB032X15	GTBOXB032X15	minibox polyolefin self-ext UL 2:1 125°	blue	3.2 mm ²	15
GTBOXB048X10	GTBOXB048X10	minibox polyolefin self-ext UL 2:1 125°	blue	4.8 mm ²	10
GTBOXB064X10	GTBOXB064X10	minibox polyolefin self-ext UL 2:1 125°	blue	6.4 mm ²	10
GTBOXB095X10	GTBOXB095X10	minibox polyolefin self-ext UL 2:1 125°	blue	9.5 mm ²	10
GTBOXB127X10	GTBOXB127X10	minibox polyolefin self-ext UL 2:1 125°	blue	12.7 mm ²	10
GTBOXB190X05	GTBOXB190X05	minibox polyolefin self-ext UL 2:1 125°	blue	19 mm ²	5
GTBOXB254X05	GTBOXB254X05	minibox polyolefin self-ext UL 2:1 125°	blue	25.4 mm ²	5
GTBOXN016X15	GTBOXN016X15	minibox polyolefin self-ext UL 2:1 125°	black	1.6 mm ²	15
GTBOXN024X15	GTBOXN024X15	minibox polyolefin self-ext UL 2:1 125°	black	2.4 mm ²	15
GTBOXN032X15	GTBOXN032X15	minibox polyolefin self-ext UL 2:1 125°	black	3.2 mm ²	15
GTBOXN048X10	GTBOXN048X10	minibox polyolefin self-ext UL 2:1 125°	black	4.8 mm ²	10
GTBOXN064X10	GTBOXN064X10	minibox polyolefin self-ext UL 2:1 125°	black	6.4 mm ²	10
GTBOXN095X10	GTBOXN095X10	minibox polyolefin self-ext UL 2:1 125°	black	9.5 mm ²	10
GTBOXN127X10	GTBOXN127X10	minibox polyolefin self-ext UL 2:1 125°	black	12.7 mm ²	10
GTBOXN190X05	GTBOXN190X05	minibox polyolefin self-ext UL 2:1 125°	black	19 mm ²	5
GTBOXN254X05	GTBOXN254X05	minibox polyolefin self-ext UL 2:1 125°	black	25.4 mm ²	5
GTBOXG016X15	GTBOXG016X15	minibox polyolefin self-ext UL 2:1 125°	yellow-green	1.6 mm ²	15
GTBOXG024X15	GTBOXG024X15	minibox polyolefin self-ext UL 2:1 125°	yellow-green	2.4 mm ²	15
GTBOXG032X15	GTBOXG032X15	minibox polyolefin self-ext UL 2:1 125°	yellow-green	3.2 mm ²	15
GTBOXG048X10	GTBOXG048X10	minibox polyolefin self-ext UL 2:1 125°	yellow-green	4.8 mm ²	10
GTBOXG064X10	GTBOXG064X10	minibox polyolefin self-ext UL 2:1 125°	yellow-green	6.4 mm ²	10
GTBOXG095X10	GTBOXG095X10	minibox polyolefin self-ext UL 2:1 125°	yellow-green	9.5 mm ²	10
GTBOXG127X10	GTBOXG127X10	minibox polyolefin self-ext UL 2:1 125°	yellow-green	12.7 mm ²	10
GTBOXG190X05	GTBOXG190X05	minibox polyolefin self-ext UL 2:1 125°	yellow-green	19 mm ²	5
GTBOXG254X05	GTBOXG254X05	minibox polyolefin self-ext UL 2:1 125°	yellow-green	25.4 mm ²	5



Pre-printed tags and accessory services

Speed Rail	pg. 52
Pre-printed tags for Cabur terminal blocks	pg. 54
Pre-printed tags for Cabur terminal blocks with spring-clamps	pg. 56
Personalised printing service	pg. 57

Speed Rail

Windows™ application for terminal blocks for rails and panels

**DOWNLOADABLE
FREE OF CHARGE FROM
WWW.CABUR.EU**

Speed Rail is a software application designed to simplify and speed up the design and completion of a rail assembly, using Cabur terminal blocks.

Thanks to its **intuitive interface** and **visual elements**, Speed Rail is easy to use and does not require any special technical skills. In addition, the program guides and helps the user throughout all of the rail assembly design stages:

- it automatically inserts and removes the end sections if necessary to protect uncovered contacts or where needed to maintain insulation;
- automatically inserts cross-connection barriers in the case of connections that are too near too each other;
- alerts the user to short circuit risks and suggests insertion of an end section or barrier;
- arranges connections in the best possible way to ensure maximum insulation.

Speed Rail allows you to plan your rail assembly quickly and efficiently, starting from the holes in the mounting rail and the arrangement of the supports, through to insertion of terminal blocks, marking, creation of connections between terminal blocks, and finally completing the details such as insertion of the modular test plugs and the test socket plugs.

Thanks to the **3D display** you can view your rail assembly from any angle, just as if you were holding it in your hand. You can also observe its development as you go through the various stages of completion.

You can easily choose the terminal blocks best suited to your requirements, thanks to the technical data integrated into the software. Once you have identified the terminal blocks, Speed Rail will guide you through the choice of accessories, saving you time by eliminating the need to search for codes and verify compatibility in catalogues.

Once all the details have been defined, Speed Rail will automatically produce a bill of materials in PDF form, with detailed information about all the characteristics of the accessories, marking, and terminal blocks used, as well as the settings for the marking rail, **and allows you to immediately request a quotation for the products needed and/or the rail assembly mounting service.**

Speed Rail can be downloaded for free from the website: www.cabur.eu

Technical requirements for installation:

- Platform:
 PC with operating system Microsoft® Windows™ XP or later.
 512 MB RAM minimum.
 Hard disk space: 50 MB for basic installation, 155 MB for full installation (including video tutorials for software use).
 Video viewer: Microsoft® Windows™ Media Player or compatible.



ADVANTAGES

FASTER AND MORE EFFICIENT RAIL ASSEMBLY DESIGN	POSSIBLE TO REQUEST A QUOTATION WITH JUST ONE CLICK
AUTOMATIC VERIFICATION AND GUIDED CORRECTION	NO CAD PLATFORM IS NECESSARY
AUTOMATIC PREPARATION OF THE BILL OF MATERIALS	POSSIBILITY TO IMPORT AND EXPORT FILES TO AND FROM MARKING PRO IN CSV FORMAT

Speed Rail

Screenshots.

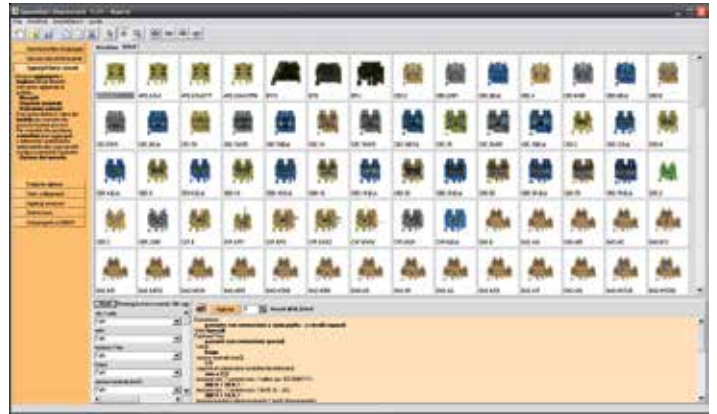
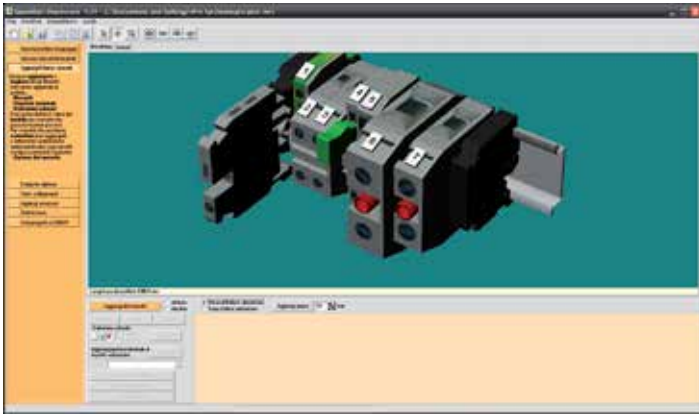

Output example.

Once the terminal blocks have been designed with Speed Rail, a PDF document is obtained which contains the following elements:

- bill of materials/component list, calculated on the basis of the number of terminal blocks to be completed (see figure 1);
- description of the processes (see figure 2);
- terminal block mounting diagram (see figure 3);
- connection and cross-connection barrier assembly diagram (see figure 4)
- accessory assembly diagram;
- marking assembly diagram.

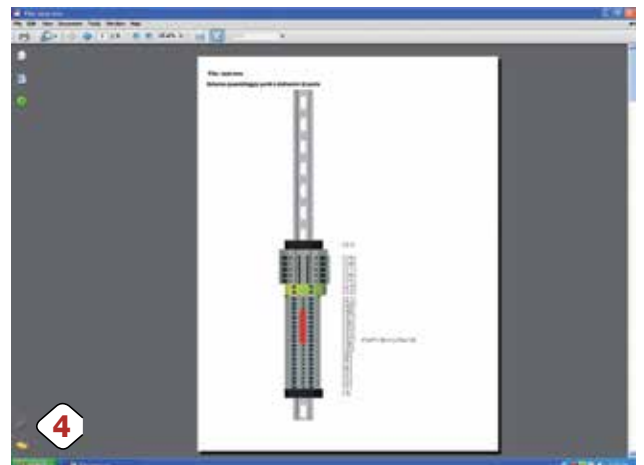
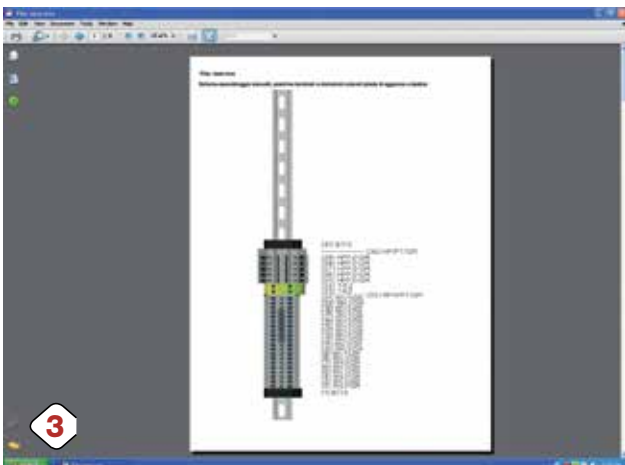
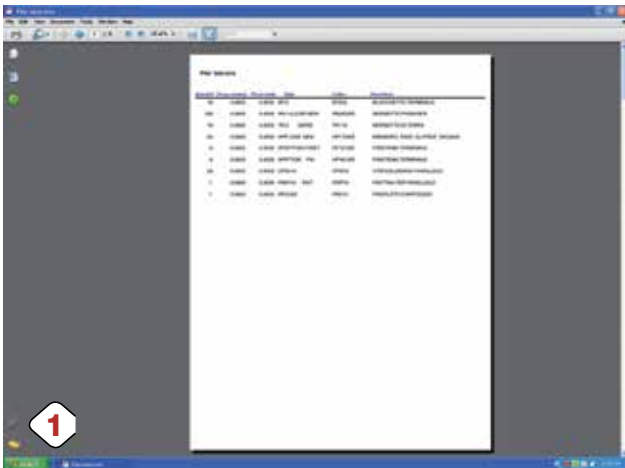

Pre-printed tags for Cabur terminal blocks

CNU/8/51 for HORIZONTAL and VERTICAL printing

- Tags appropriate for numbering all types of terminal blocks (screw clamp and spring clamp) in cards of 100 elements in packages of 500 tags.
- Made of white polycarbonate, with black printing, to be directly inserted into the housing either before or after the mounting of the rail assembly.
- **Tag dimensions: 8 x 5.1 mm. Pitch on CBC.2 and HMM.2/GR.**
- **Mounting of single tag on all Cabur terminal blocks.**



CODES FOR TAGS WITH VERTICAL NUMBERS	CODES FOR TAGS WITH HORIZONTAL NUMBERS	DESCRIPTION	QUANTITY PK
NU0851	NU0851	CNU/8/030 100 TAGS BLANK	1,500
NU0851001V	NU0851001	CNU/8/001 TAGS NO. 1 to 50	500
NU0851010V	NU0851010	CNU/8/010 TAGS. NO. 10	500
NU0851011V	NU0851011	CNU/8/11 TAGS. NO. 11	500
NU0851012V	NU0851012	CNU/8/12 TAGS. 12	500
NU0851013V	NU0851013	CNU/8/13 TAGS. NO. 13	500
NU0851014V	NU0851014	CNU/8/14 TAGS. NO. 14	500
NU0851015V	NU0851015	CNU/8/15 TAGS. NO. 15	500
NU0851016V	NU0851016	CNU/8/16 TAGS. NO. 16	500
NU0851017V	NU0851017	CNU/8/17 TAGS. NO. 17	500
NU0851018V	NU0851018	CNU/8/18 TAGS. NO. 18	500
NU0851019V	NU0851019	CNU/8/19 TAGS. NO. 19	500
NU0851020V	NU0851020	CNU/8/20 TAGS. NO. 20	500
NU085102AV	NU085102A	CNU/8/2A TAGS. - MARKED 2A	500
NU0851051V	NU0851051	CNU/8/051 TAGS from 51 to 100	500
NU08510L1V	NU08510L1	CNU/8/L1 TAGS. - MARKED L1	500
NU08510L2V	NU08510L2	CNU/8/L2 TAGS. - MARKED L2	500
NU08510L3V	NU08510L3	CNU/8/L3 TAGS. - MARKED L3	500
NU08510NIV	NU08510NI	CNU/8/NI TAGS. - MARKED NI	500
NU08510PEV	NU08510PE	CNU/8/PE TAGS. - MARKED PE	500
NU08510R1V	NU08510R1	CNU/8/R1 TAGS. - MARKED R1	500
NU08510S1V	NU08510S1	CNU/8/S1 TAGS. - MARKED S1	500
NU08510S2V	NU08510S2	CNU/8/S2 TAGS. - MARKED S2	500
NU08510S3V	NU08510S3	CNU/8/S3 TAGS. - MARKED S3	500
NU08510U1V	NU08510U1	CNU/8/U1 TAGS. - MARKED U1	500
NU08510U2V	NU08510U2	CNU/8/U2 TAGS. - MARKED U2	500
NU08510V	NU08510	CNU/8/000 TAGS 0	500
NU08510V1V	NU08510V1	CNU/8/V1 TAGS. - MARKED V1	500
NU08510V2V	NU08510V2	CNU/8/V2 TAGS. - MARKED V2	500
NU08510W1V	NU08510W1	CNU/8/W1 TAGS. - MARKED W1	500
NU08510W2V	NU08510W2	CNU/8/W2 TAGS. - MARKED W2	500
NU0851101V	NU0851101	CNU/8/101 TAGS. - from 101 to 150	500
NU085110V	NU085110	CNU/8/025 100 TAGS =	500
NU085111V	NU085111	CNU/8/023 100 TAGS +	500
NU085112V	NU085112	CNU/8/024 100 TAGS -	500
NU085114V	NU085114	CNU/8/027 TAGS EARTH	500
NU0851151V	NU0851151	CNU/8/151 TAGS from 151 to 200	500
NU085115V	NU085115	CNU/8/028 TAG EARTH CIRCLE	500
NU08511V	NU08511	CNU/8/111 100 TAGS 1	500
NU0851201V	NU0851201	CNU/8/201 TAGS from 201 to 250	500
NU0851251V	NU0851251	CNU/8/251 TAGS from 251 to 300	500
NU08512V	NU08512	CNU/8/222 100 TAGS 2	500
NU0851301V	NU0851301	CNU/8/301 TAGS from 301 to 350	500
NU0851351V	NU0851351	CNU/8/351 TAGS from 351 to 400	500
NU08513V	NU08513	CNU/8/333 100 TAGS 3	500
NU0851401V	NU0851401	CNU/8/401 TAGS from 401 to 450	500
NU0851451V	NU0851451	CNU/8/451 TAGS from 451 to 500	500
NU08514V	NU08514	CNU/8/444 100 TAGS 4	500
NU0851501V	NU0851501	CNU/8/501 TAGS from 501 to 550	500

Writing type

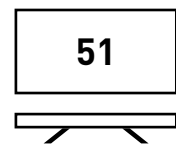

HORIZONTAL

Writing type

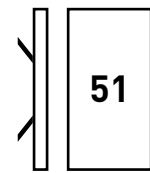

VERTICAL

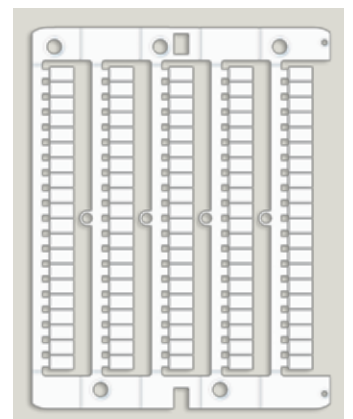

Card CNU/8/51
Code NU0851

Pre-printed tags for Cabur terminal blocks

CNU/8/51 for HORIZONTAL and VERTICAL printing

- Tags appropriate for numbering all types of terminal blocks (screw clamp and spring clamp) in cards of 100 elements in packages of 500 tags.
- Made of white polycarbonate, with black printing, to be directly inserted into the housing either before or after the mounting of the rail assembly.
- **Tag dimensions: 8 x 5.1 mm. Pitch on CBC.2 and HMM.2/GR.**
- **Mounting of single tag on all Cabur terminal blocks.**

CODES FOR TAGS WITH VERTICAL NUMBERS	CODES FOR TAGS WITH HORIZONTAL NUMBERS	DESCRIPTION	QUANTITY PK
NU0851510V	NU0851510	CNU/8/510 TAGS from 1 to 10	500
NU0851520V	NU0851520	CNU/8/520 TAGS from 11 to 20	500
NU0851530V	NU0851530	CNU/8/530 TAGS from 21 to 30	500
NU0851540V	NU0851540	CNU/8/540 TAGS from 31 to 40	500
NU0851550V	NU0851550	CNU/8/550 TAGS from 41 to 50	500
NU0851551V	NU0851551	CNU/8/551 TAGS from 551 to 600	500
NU0851560V	NU0851560	CNU/8/560 TAGS from 51 to 60	500
NU0851570V	NU0851570	CNU/8/570 TAGS from 61 to 70	500
NU0851580V	NU0851580	CNU/8/580 TAGS from 71 to 80	500
NU0851590V	NU0851590	CNU/8/590 TAGS from 81 to 90	500
NU08515V	NU08515	CNU/8/555 100 TAGS 5	500
NU0851600V	NU0851600	CNU/8/600 TAGS from 91 to 100	500
NU0851601V	NU0851601	CNU/8/601 TAGS from 601 to 650	500
NU0851651V	NU0851651	CNU/8/651 TAGS from 651 to 700	500
NU08516V	NU08516	CNU/8/666 100 TAGS 6	500
NU0851701V	NU0851701	CNU/8/701 TAGS from 701 to 750	500
NU0851751V	NU0851751	CNU/8/751 TAGS from 751 to 800	500
NU08517V	NU08517	CNU/8/777 100 TAGS 7	500
NU0851801V	NU0851801	CNU/8/801 TAGS from 801 to 850	500
NU0851851V	NU0851851	CNU/8/851 TAGS from 851 to 900	500
NU08518V	NU08518	CNU/8/888 100 TAGS 8	500
NU0851901V	NU0851901	CNU/8/901 TAGS from 901 to 950	500
NU0851951V	NU0851951	CNU/8/951 TAGS from 951 to 1,000	500
NU08519V	NU08519	CNU/8/999 100 TAGS 9	500
NU0851AV	NU0851A	CNU/8/031 100 TAGS A	500
NU0851BV	NU0851B	CNU/8/032 100 TAGS B	500
NU0851CV	NU0851C	CNU/8/033 100 TAGS C	500
NU0851DV	NU0851D	CNU/8/034 100 TAGS D	500
NU0851EV	NU0851E	CNU/8/035 100 TAGS E	500
NU0851FV	NU0851F	CNU/8/036 100 TAGS F	500
NU0851GV	NU0851G	CNU/8/037 100 TAGS G	500
NU0851HV	NU0851H	CNU/8/038 100 TAGS H	500
NU0851IV	NU0851I	CNU/8/043 100 TAGS I	500
NU0851JV	NU0851J	CNU/8/049 100 TAGS J	500
NU0851KV	NU0851KV	CNU/8/050 TAGS K	500
NU0851LV	NU0851L	CNU/8/044 100 TAGS L	500
NU0851MV	NU0851M	CNU/8/045 100 TAGS M	500
NU0851NV	NU0851N	CNU/8/016 100 TAGS N	500
NU0851OV	NU0851O	CNU/8/046 100 TAGS O	500
NU0851PV	NU0851P	CNU/8/047 100 TAGS P	500
NU0851QV	NU0851Q	CNU/8/048 100 TAGS Q	500
NU0851RV	NU0851R	CNU/8/013 100 TAGS R	500
NU0851SV	NU0851S	CNU/8/014 100 TAGS S	500
NU0851TV	NU0851T	CNU/8/015 100 TAGS T	500
NU0851UV	NU0851UV	CNU/8/017 100 TAGS U	500
NU0851VV	NU0851V	CNU/8/018 100 TAGS V	500
NU0851WV	NU0851W	CNU/8/019 100 TAGS W	500
NU0851XV	NU0851X	CNU/8/020 100 TAGS X	500
NU0851YV	NU0851Y	CNU/8/021 100 TAGS Y	500
NU0851ZV	NU0851Z	CNU/8/022 100 TAGS Z	500



Writing type

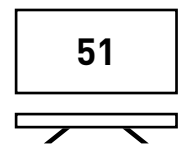

HORIZONTAL

Writing type

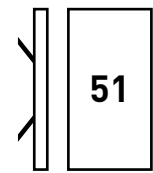

VERTICAL



Mounting on Cabur terminal blocks.

Pre-printed tags for Cabur terminal blocks

CNU/5

Tags appropriate for **labelling modular BPL.4 and TPL.4 rail assemblies in cards of 100 elements.**

In white polyamide with black printing, to be inserted directly into the special housing either before or after preparing the rail assembly.

Standard 5 mm pitch, height 5 mm.



Card CNU/5/123
Code N5123

CODE	ID CODE TABLE	MARKING
	{100 elements}	
NU005	CNU/5/030	blank
N5110	CNU/5/110	1-10 (10 series)
N5250	CNU/5/250	1-50 (2 series)
N5350	CNU/5/350	51-100 (2 series)
N5016	CNU/5/016	N
N5017	CNU/5/017	R
N5018	CNU/5/018	S
N5015	CNU/5/015	T
N5023	CNU/5/023	+
N5024	CNU/5/024	-
N5025	CNU/5/025	~
N5026	CNU/5/026	±
N5027	CNU/5/027	⊕
N5029	CNU/5/029	=
N5123	CNU/5/123	1-2-3-4-5-6-7-8-9-10

Pre-printed tags for Cabur spring-clamp terminal blocks

The rapid SHZ numbering strips can be inserted in the sides of the terminal block or in the special housing created on the upper part of the terminal block.

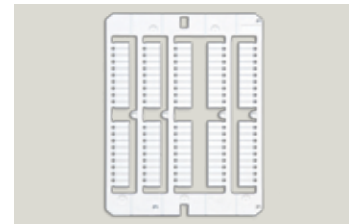
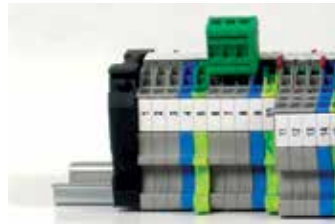

Tag SH004

Rapid numbering strips, Series SHZ

SHZ/1(*)		SHZ/2 (*)		MARKING
CODE	ID CODE	CODE	ID CODE	
SH004	SHZ/1/00	SH001	SHZ/2/00	Blank strips
SH419	SHZ/1/19	SH119	SHZ/2/19	Strip numbered from 1 to 9
SH4AA	SHZ/1/AA	SH1AA	SHZ/2/AA	Strip, marked A (1)
SH4BB	SHZ/1/BB	SH1BB	SHZ/2/BB	Strip, marked B (1)
SH4CC	SHZ/1/CC	SH1CC	SHZ/2/CC	Strip, marked C (1)
SH4DD	SHZ/1/DD	SH1DD	SHZ/2/DD	Strip, marked D (1)
SH4EE	SHZ/1/EE	SH1EE	SHZ/2/EE	Strip, marked E (1)
SH4FF	SHZ/1/FF	SH1FF	SHZ/2/FF	Strip, marked F (1)
SH4GG	SHZ/1/GG	SH1GG	SHZ/2/GG	Strip, marked G (1)
SH4HH	SHZ/1/HH	SH1HH	SHZ/2/HH	Strip, marked H (1)
SH4II	SHZ/1/II	SH1II	SHZ/2/II	Strip, marked I (1)
SH4JJ	SHZ/1/JJ	SH1JJ	SHZ/2/JJ	Strip, marked J (1)
SH4KK	SHZ/1/KK	SH1KK	SHZ/2/KK	Strip, marked K (1)
SH4LL	SHZ/1/LL	SH1LL	SHZ/2/LL	Strip, marked L (1)
SH4MM	SHZ/1/MM	SH1MM	SHZ/2/MM	Strip, marked M (1)
SH4NN	SHZ/1/NN	SH1NN	SHZ/2/NN	Strip, marked N (1)
SH400	SHZ/1/00	SH100	SHZ/2/00	Strip, marked O (1)
SH4PP	SHZ/1/PP	SH1PP	SHZ/2/PP	Strip, marked P (1)
SH4QQ	SHZ/1/QQ	SH1QQ	SHZ/2/QQ	Strip, marked Q (1)
SH4RR	SHZ/1/RR	SH1RR	SHZ/2/RR	Strip, marked R (1)
SH4SS	SHZ/1/SS	SH1SS	SHZ/2/SS	Strip, marked S (1)
SH4TT	SHZ/1/TT	SH1TT	SHZ/2/TT	Strip, marked T (1)

SHZ/1(*)		SHZ/2 (*)		MARKING
CODE	ID CODE	CODE	ID CODE	
SH4UU	SHZ/1/UU	SH1UU	SHZ/2/UU	Strip, marked U (1)
SH4VV	SHZ/1/VV	SH1VV	SHZ/2/VV	Strip, marked V (1)
SH4WW	SHZ/1/WW	SH1WW	SHZ/2/WW	Strip, marked W (1)
SH4XX	SHZ/1/XX	SH1XX	SHZ/2/XX	Strip, marked X (1)
SH4YY	SHZ/1/YY	SH1YY	SHZ/2/YY	Strip, marked Y (1)
SH4ZZ	SHZ/1/ZZ	SH1ZZ	SHZ/2/ZZ	Strip, marked Z (1)
SH4G1	SHZ/1/G1	SH1G1	SHZ/2/G1	Strip, marked =
SH4G2	SHZ/1/G2	SH1G2	SHZ/2/G2	Strip, marked +
SH4G2	SHZ/1/G3	SH1G3	SHZ/2/G3	Strip, marked -
SH4G4	SHZ/1/G4	SH1G4	SHZ/2/G4	Strip, marked ~
SH4G5	SHZ/1/G5	SH1G5	SHZ/2/G5	Strip, marked ±
SH4G6	SHZ/1/G6	SH1G6	SHZ/2/G6	Strip, marked ⊕
SH4G7	SHZ/1/G7	SH1G7	SHZ/2/G7	Strip, marked +
SH4G8	SHZ/1/G8	SH1G8	SHZ/2/G8	Strip, marked /
SH4G9	SHZ/1/G9	SH1G9	SHZ/2/G9	Strip, marked {

SNZ.4 for terminal block RN.1

SHZ/4		MARKING
CODE	ID CODE	
SN008	SNZ/4/00	Blank strips
SN819	SNZ/4/19	Strip numbered from 1 to 9

(* please contact our sales office for information about availability

Personalised printing service

Special numbering for terminal block marking

Cabur can supply, on request, special marking tags with numbers, letters, symbols and customised logos in packs of 500 tags, printed using the CaburJet system.

Request special marking by specifying the following on the order:

- A** - Item code, selected from those found in the table (e.g. NU0851SP)
- B** - Number of tags ordered (min. 500 pcs. / 1 pk.)
- C** - Writing type (horizontal or vertical)
- D** - Contents (text, numbers, symbols) to be printed on the tags (e.g. A1B)

To optimise the service, as an alternative or in addition to that required at points c) and d), we recommend sending Cabur a MarKing Pro file created with the specific requirements of the order.

For example, by ordering:

Code: NU0851SP
 Quantity: 1000
 Writing type: horizontal
 Content: ABC

You will receive 2 packs of 500 tags each of CNU/8/51, personalised as requested.

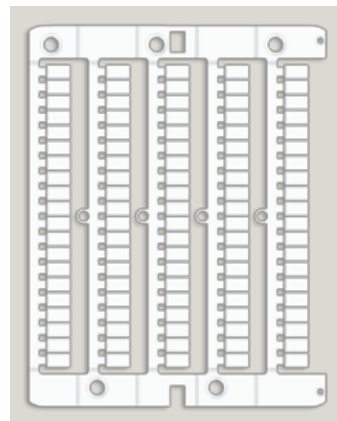
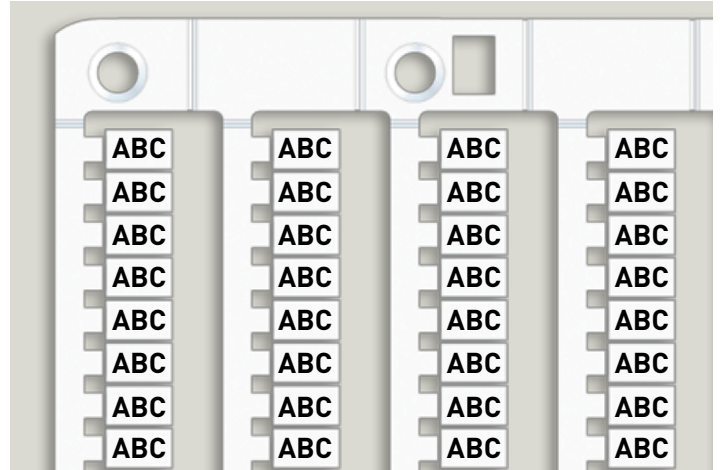

Mounting on Cabur terminal blocks

Writing type

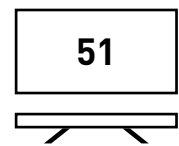

HORIZONTAL

Writing type

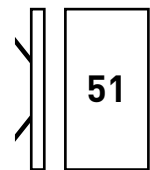

VERTICAL

SPECIAL NUMBERING		
CODE	ID CODE	DESCRIPTION
NU0800SP	NU0800SP	CNU/8/00 - special marking
NU0851SP	NU0851SP	CNU/8/51 - special marking
NU0861SP	NU0861SP	CNU/8/61 - special marking
NU1051SP	NU1051SP	CNU/10/51 - special marking
NU1061SP	NU1061SP	CNU/10/61 - special marking
SH004SP	SH004SP	SHZ.1 - special marking
NUWDU50SP	NUWDU50SP	NUWDU50 - special numbering
NUWDK50SP	NUWDK50SP	NUWDK50 - special numbering
NUPUTUK50SP	NUPUTUK50SP	NUPUTUK50 - special numbering
NUL1061	NUL1061	NUL1061 - special numbering



Personalised printing service

Special numbering for wire marking

Cabur can supply, on request, special marking tags for wires, with numbers, letters, symbols and customised logos in packs of 500 tags, printed using the CaburJet system.

Request special numberings for wire marking, by specifying the following on the order:

- A** - Item code, selected from those found in the table (e.g. NUT15SP)
- B** - Number of tags ordered (min. 500 pcs. / 1 pk.)
- C** - Contents (text, numbers, symbols) to be printed on the tags (e.g. A1B)

To optimise the service, as an alternative to or in addition to that required at point c), we recommend sending Cabur a MarKing Pro file created with the specific requirements of the order.

For example, by ordering:

Code: NUT15SP
 Quantity: 1500
 Content: ABC

An order will be placed for 3 packs of 500 tabs each of NUT15, customised as requested.

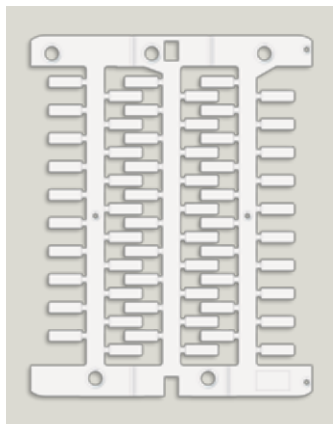
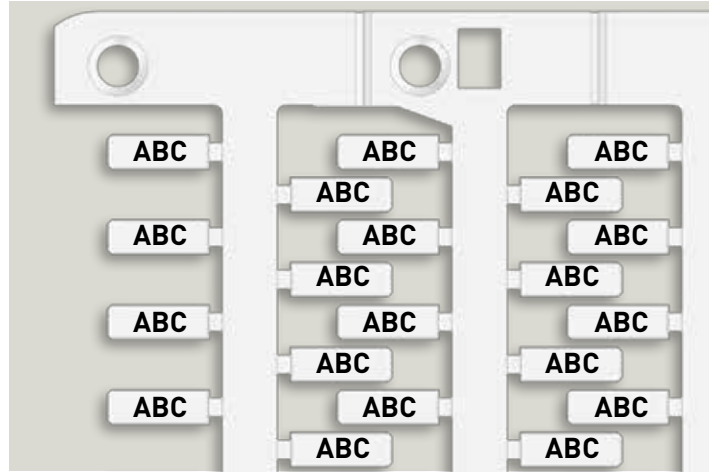

Mounting on Cabur terminal blocks

Writing type

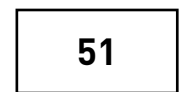

HORIZONTAL

SPECIAL NUMBERING		
CODE	ID CODE	DESCRIPTION
NUT12SP	NUT12SP	NUT12SP - special numbering
NUT12YSP	NUT12YSP	NUT12YSP - special numbering
NUT15SP	NUT15SP	NUT15SP - special numbering
NUT15YSP	NUT15YSP	NUT15YSP - special numbering
NUT18SP	NUT18SP	NUT18SP - special numbering
NUT18YSP	NUT18YSP	NUT18YSP - special numbering
NUT23SP	NUT23SP	NUT23SP - special numbering
NUT23YSP	NUT23YSP	NUT23YSP - special numbering



IDACBW20	39	IDACMW45	37	IDACNW15	37
IDACBW25	40	IDACMW60	40	IDACNW20	40
IDACBW30	41	IDACNW08	37	IDACNW25	41
IDACBW35	42	IDACNW15	37	IDACNW30	41
IDACBW45	36	IDACNW20	37	IDACNW35	41
IDACBW60	37	IDACNW25	37	IDACNW45	41
IDACCW08	38	IDACNW30	38	IDACNW60	41
IDACCW15	38	IDACNW35	38	IDACOW08	41
IDACCW20	39	IDACNW45	39	IDACOW15	41
IDACCW25	40	IDACNW60	40	IDACOW20	41
IDACCW30	41	IDACOW08	40	IDACOW25	41
IDACCW35	42	IDACOW15	36	IDACOW30	41
IDACCW45	36	IDACOW20	37	IDACOW35	41
IDACCW60	37	IDACOW25	37	IDACOW45	41
IDACDW08	38	IDACOW30	37	IDACOW60	41
IDACDW15	38	IDACOW35	38	IDACPW08	41
IDACDW20	39	IDACOW45	38	IDACPW15	41
IDACDW25	40	IDACOW60	39	IDACPW20	41
IDACDW30	41	IDACPW08	40	IDACPW25	41
IDACDW35	42	IDACPW15	41	IDACPW30	41
IDACDW45	36	IDACPW20	36	IDACPW35	41
IDACDW60	37	IDACPW25	37	IDACPW45	41
IDACEW08	38	IDACPW30	38	IDACPW60	41
IDACEW15	38	IDACPW35	38	IDACQW08	41
IDACEW20	39	IDACPW45	39	IDACQW15	41
IDACEW25	40	IDACPW60	40	IDACQW20	41
IDACEW30	41	IDACEW08	41	IDACQW25	41
IDACEW35	42	IDACEW15	36	IDACQW30	41
IDACEW45	36	IDACEW20	37	IDACQW35	41
IDACEW60	37	IDACEW25	37	IDACQW45	41
IDACFW08	38	IDACEW30	38	IDACQW60	41
IDACFW15	38	IDACEW35	38	IDACRW08	41
IDACFW20	39	IDACEW45	39	IDACRW15	41
IDACFW25	40	IDACEW60	40	IDACRW20	41
IDACFW30	41	IDACFW08	41	IDACRW25	41
IDACFW35	42	IDACFW15	36	IDACRW30	41
IDACFW45	36	IDACFW20	37	IDACRW35	41
IDACFW60	37	IDACFW25	38	IDACRW45	41
IDACGW08	38	IDACFW30	38	IDACRW60	41
IDACGW15	38	IDACFW35	39	IDACSW08	41
IDACGW20	39	IDACFW45	40	IDACSW15	41
IDACGW25	40	IDACFW60	41	IDACSW20	41
IDACGW30	41	IDACGW08	42	IDACSW25	41
IDACGW35	42	IDACGW15	36	IDACSW35	41
IDACGW45	36	IDACGW20	37	IDACSW60	41
IDACGW60	37	IDACGW25	38	IDACSW75	41
IDACHW08	38	IDACGW30	38	IDACSW	41
IDACHW15	38	IDACGW35	39	IDACSW	41
IDACHW20	39	IDACGW45	40	IDACSW	41
IDACHW25	40	IDACGW60	41	IDACSW	41
IDACHW30	41	IDACHW08	42	IDACSW	41
IDACHW35	42	IDACHW15	36	IDACSW	41
IDACHW45	36	IDACHW20	37	IDACSW	41
IDACHW60	37	IDACHW25	38	IDACSW	41
IDACIW08	38	IDACHW30	38	IDACSW	41
IDACIW15	38	IDACHW35	39	IDACSW	41
IDACIW20	39	IDACHW45	40	IDACSW	41
IDACIW25	40	IDACHW60	41	IDACSW	41
IDACIW30	41	IDACIW08	42	IDACSW	41
IDACIW35	42	IDACIW15	36	IDACSW	41
IDACIW45	36	IDACIW20	37	IDACSW	41
IDACIW60	37	IDACIW25	38	IDACSW	41
IDACJW08	38	IDACIW30	38	IDACSW	41
IDACJW15	38	IDACIW35	39	IDACSW	41
IDACJW20	39	IDACIW45	40	IDACSW	41
IDACJW25	40	IDACIW60	41	IDACSW	41
IDACJW30	41	IDACJW08	42	IDACSW	41
IDACJW35	42	IDACJW15	36	IDACSW	41
IDACJW45	36	IDACJW20	37	IDACSW	41
IDACJW60	37	IDACJW25	38	IDACSW	41
IDACKW08	38	IDACJW30	38	IDACSW	41
IDACKW15	38	IDACJW35	39	IDACSW	41
IDACKW20	39	IDACJW45	40	IDACSW	41
IDACKW25	40	IDACKW08	42	IDACSW	41
IDACKW30	41	IDACKW15	36	IDACSW	41
IDACKW35	42	IDACKW20	37	IDACSW	41
IDACKW45	36	IDACKW25	38	IDACSW	41
IDACKW60	37	IDACKW30	38	IDACSW	41
IDACKW75	38	IDACKW35	39	IDACSW	41
IDACKW90	39	IDACKW45	40	IDACSW	41
IDACKW105	40	IDACKW60	41	IDACSW	41
IDACKW120	41	IDACKW75	42	IDACSW	41
IDACKW135	42	IDACKW90	36	IDACSW	41
IDACKW150	36	IDACKW105	37	IDACSW	41
IDACKW165	37	IDACKW120	38	IDACSW	41
IDACKW180	38	IDACKW135	39	IDACSW	41
IDACKW195	39	IDACKW150	40	IDACSW	41
IDACKW210	40	IDACKW165	41	IDACSW	41
IDACKW225	41	IDACKW180	42	IDACSW	41
IDACKW240	42	IDACKW195	36	IDACSW	41
IDACKW255	36	IDACKW210	37	IDACSW	41
IDACKW270	37	IDACKW225	38	IDACSW	41
IDACKW285	38	IDACKW240	39	IDACSW	41
IDACKW300	39	IDACKW255	40	IDACSW	41
IDACKW315	40	IDACKW270	41	IDACSW	41
IDACKW330	41	IDACKW285	42	IDACSW	41
IDACKW345	42	IDACKW300	36	IDACSW	41
IDACKW360	36	IDACKW315	37	IDACSW	41
IDACKW375	37	IDACKW330	38	IDACSW	41
IDACKW390	38	IDACKW345	39	IDACSW	41
IDACKW405	39	IDACKW360	40	IDACSW	41
IDACKW420	40	IDACKW375	41	IDACSW	41
IDACKW435	41	IDACKW390	42	IDACSW	41
IDACKW450	42	IDACKW405	36	IDACSW	41
IDACKW465	36	IDACKW420	37	IDACSW	41
IDACKW480	37	IDACKW435	38	IDACSW	41
IDACKW495	38	IDACKW450	39	IDACSW	41
IDACKW510	39	IDACKW465	40	IDACSW	41
IDACKW525	40	IDACKW480	41	IDACSW	41
IDACKW540	41	IDACKW495	42	IDACSW	41
IDACKW555	42	IDACKW510	36	IDACSW	41
IDACKW570	36	IDACKW525	37	IDACSW	41
IDACKW585	37	IDACKW540	38	IDACSW	41
IDACKW600	38	IDACKW555	39	IDACSW	41
IDACKW615	39	IDACKW570	40	IDACSW	41
IDACKW630	40	IDACKW585	41	IDACSW	41
IDACKW645	41	IDACKW600	42	IDACSW	41
IDACKW660	42	IDACKW615	36	IDACSW	41
IDACKW675	36	IDACKW630	37	IDACSW	41
IDACKW690	37	IDACKW645	38	IDACSW	41
IDACKW705	38	IDACKW660	39	IDACSW	41
IDACKW720	39	IDACKW675	40	IDACSW	41
IDACKW735	40	IDACKW690	41	IDACSW	41
IDACKW750	41	IDACKW705	42	IDACSW	41
IDACKW765	42	IDACKW720	36	IDACSW	41
IDACKW780	36	IDACKW735	37	IDACSW	41
IDACKW795	37	IDACKW750	38	IDACSW	41
IDACKW810	38	IDACKW765	39	IDACSW	41
IDACKW825	39	IDACKW780	40	IDACSW	41
IDACKW840	40	IDACKW795	41	IDACSW	41
IDACKW855	41	IDACKW810	42	IDACSW	41
IDACKW870	42	IDACKW825	36	IDACSW	41
IDACKW885	36	IDACKW840	37	IDACSW	41
IDACKW900	37	IDACKW855	38	IDACSW	41
IDACKW915	38	IDACKW870	39	IDACSW	41
IDACKW930	39	IDACKW885	40	IDACSW	41
IDACKW945	40	IDACKW900	41	IDACSW	41
IDACKW960	41	IDACKW915	42	IDACSW	41
IDACKW975	42	IDACKW930	36	IDACSW	41
IDACKW990	36	IDACKW945	37	IDACSW	41
IDACKW1005	37	IDACKW960	38	IDACSW	41
IDACKW1020	38	IDACKW975	39	IDACSW	41
IDACKW1035	39	IDACKW990	40	IDACSW	41
IDACKW1050	40	IDACKW1005	41	IDACSW	41
IDACKW1065	41	IDACKW1020	42	IDACSW	41
IDACKW1080	42	IDACKW1035	36	IDACSW	41
IDACKW1095	36	IDACKW1050	37	IDACSW	41
IDACKW1110	37	IDACKW1065	38	IDACSW	41
IDACKW1125	38	IDACKW1080	39	IDACSW	41
IDACKW1140	39	IDACKW1095	40	IDACSW	41
IDACKW1155	40	IDACKW1110	41	IDACSW	41
IDACKW1170	41	IDACKW1125	42	IDACSW	41
IDACKW1185	42	IDACKW1140	36	IDACSW	41
IDACKW1200	36	IDACKW1155	37	IDACSW	41
IDACKW1215	37	IDACKW1170	38	IDACSW	41
IDACKW1230	38	IDACKW1185	39	IDACSW	41
IDACKW1245	39	IDACKW1200	40	IDACSW	41
IDACKW1260	40	IDACKW1215	41	IDACSW	41
IDACKW1275	41	IDACKW1230	42	IDACSW	41
IDACKW1290	42	IDACKW1245	36	IDACSW	41
IDACKW1305	36	IDACKW1260	37	IDACSW	41
IDACKW1320	37	IDACKW1275	38	IDACSW	41
IDACKW1335	38	IDACKW1290	39	IDACSW	41
IDACKW1350	39	IDACKW1305	40	IDACSW	41
IDACKW1365	40	IDACKW1320	41	IDACSW	41
IDACKW1380	41	IDACKW1335	42	IDACSW	41
IDACKW1395	42	IDACKW1350	36	IDACSW	41
IDACKW1410	36	IDACKW1365	37	IDACSW	41
IDACKW1425	37	IDACKW1380	38	IDACSW	41
IDACKW1440	38	IDACKW1395	39	IDACSW	41
IDACKW1455	39	IDACKW1410	40	IDACSW	41
IDACKW1470	40	IDACKW1425	41	IDACSW	41
IDACKW1485	41	IDACKW1440	42	IDACSW	41
IDACKW1500	42	IDACKW1455	36	IDACSW	41
IDACKW1515	36	IDACKW1470	37	IDACSW	41
IDACKW1530	37	IDACKW1485	38	IDACSW	41
IDACKW1545	38	IDACKW1500	39	IDACSW	41
IDACKW1560	39	IDACKW1515	40	IDACSW	41
IDACKW1575	40	IDACKW1530	41	IDACSW	41
IDACKW1590	41	IDACKW1545	42	IDACSW	41
IDACKW1605	42	IDACKW1560	36	IDACSW	41
IDACKW1620	36	IDACKW1575	37	IDACSW	41
IDACKW1635	37	IDACKW1590	38	IDACSW	41
IDACKW1650	38	IDACKW1605	39	IDACSW	41
IDACKW1665	39	IDACKW1620	40	IDACSW	41
IDACKW1680	40	IDACKW1635	41	IDACSW	41
IDACKW1695	41	IDACKW1650	42	IDACSW	41
IDACKW1710	42	IDACKW1665	36	IDACSW	41
IDACKW1725	36	IDACKW1680	37	IDACSW	41
IDACKW1740	37	IDACKW1695	38	IDACSW	41
IDACKW1755	38	IDACKW1710	39	IDACSW	41
IDACKW1770	39	IDACKW1725	40	IDACSW	41
IDACKW1785	40	IDACKW1740	41	IDACSW	41
IDACKW1800	41	IDACKW1755	42	IDACSW	41
IDACKW1815	42	IDACKW1770	36	IDACSW	41
IDACKW1830	36	IDACKW1785	37	IDACSW	41
IDACKW1845	37	IDACKW1800	38	IDACSW	41
IDACKW1860	38	IDACKW1815	39	IDACSW	41
IDACKW1875	39	IDACKW1830	40	IDACSW	41
IDACKW1890	40	IDACKW1845	41	IDACSW	41
IDACKW1905	41	IDACKW1860	42	IDACSW	41
IDACKW1920	42	IDACKW1875	36	IDACSW	41
IDACKW1935	36	IDACKW1890	37	IDACSW	41
IDACKW1950	37	IDACKW1905	38	IDACSW	41
IDACKW1965	38	IDACKW1920	39	IDACSW	41
IDACKW1980	39	IDACKW1935	40	IDACSW	41
IDACKW1995	40	IDACKW1950	41	IDACSW	41
IDACKW2010	41	IDACKW1965	42	IDACSW	41
IDACKW2025	42	IDACKW1980	36	IDACSW	41
IDACKW2040	36	IDACKW1995	37	IDACSW	41
IDACKW2055	37	IDACKW2010	38	IDACSW	41
IDACKW2070	38	IDACKW2025	39	IDACSW	41
IDACKW2085	39	IDACKW2040	40	IDACSW	41
IDACKW2100	40	IDACKW2055	41	IDACSW	41
IDACKW2115	41	IDACKW2070	42	IDACSW	41
IDACKW2130	42	IDACKW2085	36	IDACSW	41
IDACKW2145	36	IDACKW2100	37	IDACSW	41
IDACKW2160	37	IDACKW2115	38	IDACSW	41
IDACKW2175	38	IDACKW2130	39	IDACSW	41
IDACKW2190	39	IDACKW2145	40	IDACSW	41
IDACKW2205	40	IDACKW2160	41	IDACSW	41
IDACKW2220	41	IDACKW2175	42	IDACSW	41
IDACKW2235	42	IDACKW2190	36	IDACSW	41
IDACKW2250	36	IDACKW2205	37	IDACSW	41
IDACKW2265	37	IDACKW2220	38	IDACSW	41
IDACKW2280	38	IDACKW2235	39	IDACSW	41
IDACKW2295	39	IDACKW2250	40	IDACSW	41
IDACKW2310	40	IDACKW2265	41	IDACSW	41
IDACKW2325	41	IDACKW2280	42	IDACSW	41
IDACKW2340	42	IDACKW2295	36	IDACSW	41
IDACKW2355	36	IDACKW2310			

CODE	ID CODE	PAGE
ADRKITEK	KITCABUREK	13
ADRKITGR	KITCABURBG	13
ADRKITMU	KITCABURMU	13
BIN043015	BIN043015	28
BIN065015	BIN065015	28
BIN100015	BIN100015	28
BIN10009A	BIN10009A	22
BIN10009AHP	BIN10009AHP	22
BIN5009A	BIN5009A	22
BIN5009AHP	BIN5009AHP	22
CAB15MM	AB15MM	33
CAB30MM	CAB30MM	33
CABDIS	CABDIS	33
CABDIS1	CABDIS1	33
CABUNC	CABUNC	33
CBIN043015	CBIN043015	28
CBIN065015	CBIN065015	28
CBIN100015	CBIN100015	28
CABURJET	CABURJET	10
CCH02	CCH/2,5-4	44
CCH06	CCH/6	44
CCV03	CCV/2,5	44
CCV04	CCV/4	44
CCV05	CCV/5	44
CLNRJET	CLNRJET	11
CS000	CSC/00	36
CS111	CSC/11	36
CS222	CSC/22	36
CS333	CSC/33	36
CS444	CSC/44	36
CS555	CSC/55	36
CS666	CSC/66	36
CS777	CSC/77	36
CS888	CSC/88	36
CS999	CSC/99	36
CSAAA	CSC/AA	36
CSBBB	CSC/BB	36
CSC00	CSC	36
CSC09	CSC/09	36
CSCCC	CSC/CC	36
CSDDD	CSC/DD	36
CSEEE	CSC/EE	36
CSFFF	CSC/FF	36
CSGGG	CSC/GG	36
CSHHH	CSC/HH	36
CSIII	CSC/II	36
CSJJJ	CSC/JJ	36
CSKKK	CSC/KK	36
CSLLL	CSC/LL	36
CT004	CB/CTL/NERO	37
CT006	CB/CTL/ROSSO	37
CT03100B	CT03100B	45
CT03100G	CT03100G	45
CT05025B	CT05025B	45
CT05025G	CT05025G	45
CT06100B	CT06100B	45
CT06100G	CT06100G	45

CODE	ID CODE	PAGE
CT08100B	CT08100B	45
CT08100G	CT08100G	45
CT10100B	CT10100B	45
CT10100G	CT10100G	45
CT12050B	CT12050B	45
CT12050G	CT12050G	45
CT15050B	CT15050B	45
CT15050G	CT15050G	45
CT20025B	CT20025B	45
CT20025G	CT20025G	45
CT25025B	CT25025B	45
CT25025G	CT25025G	45
CT30025B	CT30025B	45
CT30025G	CT30025G	45
CT40025B	CT40025B	45
CT40025G	CT40025G	45
CTB05005B	CTB05005B	46
CTB05005G	CTB05005G	46
CTB06015B	CTB06015B	46
CTB06015G	CTB06015G	46
CTB10015B	CTB10015B	46
CTB10015G	CTB10015G	46
CTB12015B	CTB12015B	46
CTB12015G	CTB12015G	46
CTB15050B	CTB15050B	46
CTB15050G	CTB15050G	46
CTB20010B	CTB20010B	46
CTB20010G	CTB20010G	46
CTB25010B	CTB25010B	46
CTB25010G	CTB25010G	46
CTB30005B	CTB30005B	46
CTB30005G	CTB30005G	46
CTB40005B	CTB40005B	46
CTB40005G	CTB40005G	46
GTA030150B	GTA030150B	48
GTA048100B	GTA048100B	48
GTA060075B	GTA060075B	48
GTA090050B	GTA090050B	48
GTA120025B	GTA120025B	48
GTA190025B	GTA190025B	48
GTA240025B	GTA240025B	48
GTA300025B	GTA300025B	48
GTA400025B	GTA400025B	48
GTBOXB016X15	GTBOXB016X15	49
GTBOXB024X15	GTBOXB024X15	49
GTBOXB032X15	GTBOXB032X15	49
GTBOXB048X10	GTBOXB048X10	49
GTBOXB064X10	GTBOXB064X10	49
GTBOXB095X10	GTBOXB095X10	49
GTBOXB127X10	GTBOXB127X10	49
GTBOXB190X05	GTBOXB190X05	49
GTBOXB254X05	GTBOXB254X05	49
GTBOXG016X15	GTBOXG016X15	49
GTBOXG024X15	GTBOXG024X15	49
GTBOXG032X15	GTBOXG032X15	49
GTBOXG048X10	GTBOXG048X10	49
GTBOXG064X10	GTBOXG064X10	49

CODE	ID CODE	PAGE
GTBOXG095X10	GTBOXG095X10	49
GTBOXG127X10	GTBOXG127X10	49
GTBOXG190X05	GTBOXG190X05	49
GTBOXG254X05	GTBOXG254X05	49
GTBOXN016X15	GTBOXN016X15	49
GTBOXN024X15	GTBOXN024X15	49
GTBOXN032X15	GTBOXN032X15	49
GTBOXN048X10	GTBOXN048X10	49
GTBOXN064X10	GTBOXN064X10	49
GTBOXN095X10	GTBOXN095X10	49
GTBOXN127X10	GTBOXN127X10	49
GTBOXN190X05	GTBOXN190X05	49
GTBOXN254X05	GTBOXN254X05	49
GTE012200B	GTE012200B	47
GTE016200B	GTE016200B	47
GTE024200B	GTE024200B	47
GTE032200B	GTE032200B	47
GTE048100B	GTE048100B	47
GTE064100B	GTE064100B	47
GTE095100B	GTE095100B	47
GTE127100B	GTE127100B	47
GTE190100B	GTE190100B	47
GTE254050B	GTE254050B	47
GTE381050B	GTE381050B	47
GTE508050B	GTE508050B	47
GTF012150B	GTF012150B	47
GTF012150T	GTF012150T	48
GTF012150W	GTF012150W	47
GTF016150B	GTF016150B	47
GTF016150GV	GTF016150GV	48
GTF016150T	GTF016150T	48
GTF016150W	GTF016150W	47
GTF024150B	GTF024150B	47
GTF024150GV	GTF024150GV	48
GTF024150T	GTF024150T	48
GTF024150W	GTF024150W	47
GTF032150B	GTF032150B	47
GTF032150GV	GTF032150GV	48
GTF032150T	GTF032150T	48
GTF032150W	GTF032150W	47
GTF048075B	GTF048075B	47
GTF048075GV	GTF048075GV	48
GTF048075T	GTF048075T	48
GTF048075W	GTF048075W	47
GTF064075B	GTF064075B	47
GTF064075GV	GTF064075GV	48
GTF064075T	GTF064075T	48
GTF064075W	GTF064075W	47
GTF095075B	GTF095075B	47
GTF095075GV	GTF095075GV	48
GTF095075T	GTF095075T	48
GTF095075W	GTF095075W	47
GTF101615B	GTF101615B	47
GTF127050B	GTF127050B	47
GTF127050GV	GTF127050GV	48
GTF127050T	GTF127050T	48
GTF190030B	GTF190030B	47

CODE	ID CODE	PAGE
GTF190030GV	GTF190030GV	48
GTF190030T	GTF190030T	48
GTF190030W	GTF190030W	48
GTF254030B	GTF254030B	47
GTF254030GV	GTF254030GV	48
GTF254030T	GTF254030T	48
GTF254030W	GTF254030W	48
GTF381030B	GTF381030B	47
GTF381030GV	GTF381030GV	48
GTF381030T	GTF381030T	48
GTF381030W	GTF381030W	48
GTF508030B	GTF508030B	47
GTF508030GV	GTF508030GV	48
GTF508030T	GTF508030T	48
GTF508030W	GTF508030W	48
GTF762015B	GTF762015B	47
ID30215	ID30215	34
ID31540	ID31540	34
ID325160	ID325160	34
IDAC..W08	IDAC..W08	35
IDAC..W15	IDAC..W15	35
IDAC..W20	IDAC..W20	35
IDAC..W25	IDAC..W25	35
IDAC..W30	IDAC..W30	35
IDAC..W35	IDAC..W35	35
IDAC..W45	IDAC..W45	35
IDAC..W60	IDAC..W60	35
ID3160700	ID3160700	34
IDEN01	IDEN01	37
INKBJET	INKBJET	11
INKBOTT1	INKBOTT1	13
INKCART5	INKCART5	13
KITPULIZIA	KITPULIZIA	13
KSPLOTTER	KSPLOTTER	12
MAN0W	MAN0W	32
MAN10W	MAN10W	32
MAN11W	MAN11W	32
MAN12W	MAN12W	32
MAN13W	MAN13W	32
MAN14W	MAN14W	32
MAN15W	MAN15W	32
MAN16W	MAN16W	32
MAN1W	MAN1W	32
MAN2W	MAN2W	32
MAN3W	MAN3W	32
MAN4W	MAN4W	32
MAN5W	MAN5W	32
MAN6W	MAN6W	32
MAN7W	MAN7W	32
MAN8W	MAN8W	32
MAN9W	MAN9W	32
MANAW	MANAW	32
MANBW	MANBW	32
MANCW	MANCW	32
MANDW	MANDW	32
MANEW	MANEW	32
MANFW	MANFW	32

CODE	ID CODE	PAGE
MANGW	MANGW	32
MANHW	MANHW	32
MANIW	MANIW	32
MANJW	MANJW	32
MANKW	MANKW	32
MANLW	MANLW	32
MANMW	MANMW	32
MANNW	MANNW	32
MANOW	MANOW	32
MANPW	MANPW	32
MANQW	MANQW	32
MANRW	MANRW	32
MANSW	MANSW	32
MANTW	MANTW	32
MANUW	MANUW	32
MANVW	MANVW	32
MANWW	MANWW	32
MANXW	MANXW	32
MANYW	MANYW	32
MANZW	MANZW	32
N5015	CNU/5/015	56
N5016	CNU/5/016	56
N5017	CNU/5/017	56
N5018	CNU/5/018	56
N5023	CNU/5/023	56
N5024	CNU/5/024	56
N5025	CNU/5/025	56
N5026	CNU/5/026	56
N5027	CNU/5/027	56
N5029	CNU/5/029	56
N5110	CNU/5/110	56
N5123	CNU/5/123	56
N5250	CNU/5/250	56
N5350	CNU/5/350	56
NU005	CNU/5/030	56
NU0550	NU0550	20
NU0800	NU0800	19
NU0800SP	NU0800SP	57
NU0851	NU0851	54
NU0851	NU0851	54
NU0851001V	NU0851001	54
NU0851010V	NU0851010	54
NU0851011V	NU0851011	54
NU0851012V	NU0851012	54
NU0851013V	NU0851013	54
NU0851014V	NU0851014	54
NU0851015V	NU0851015	54
NU0851016V	NU0851016	54
NU0851017V	NU0851017	54
NU0851018V	NU0851018	54
NU0851019V	NU0851019	54
NU0851020V	NU0851020	54
NU085102AV	NU085102A	54
NU0851051V	NU0851051	54
NU08510L1V	NU08510L1	54
NU08510L2V	NU08510L2	54
NU08510L3V	NU08510L3	54

CODE	ID CODE	PAGE
NU08510NIV	NU08510NI	54
NU08510PEV	NU08510PE	54
NU08510R1V	NU08510R1	54
NU08510S1V	NU08510S1	54
NU08510S2V	NU08510S2	54
NU08510S3V	NU08510S3	54
NU08510U1V	NU08510U1	54
NU08510U2V	NU08510U2	54
NU08510V	NU08510	54
NU08510V1V	NU08510V1	54
NU08510V2V	NU08510V2	54
NU08510W1V	NU08510W1	54
NU08510W2V	NU08510W2	54
NU0851101V	NU0851101	54
NU085110V	NU085110	54
NU085111V	NU085111	54
NU085112V	NU085112	54
NU085114V	NU085114	54
NU0851151V	NU0851151	54
NU085115V	NU085115	54
NU08511V	NU08511	54
NU0851201V	NU0851201	54
NU0851251V	NU0851251	54
NU08512V	NU08512	54
NU0851301V	NU0851301	54
NU0851351V	NU0851351	54
NU08513V	NU08513	54
NU0851401V	NU0851401	54
NU0851451V	NU0851451	54
NU08514V	NU08514	54
NU0851501V	NU0851501	54
NU0851510V	NU0851510	55
NU0851520V	NU0851520	55
NU0851530V	NU0851530	55
NU0851540V	NU0851540	55
NU0851550V	NU0851550	55
NU0851551V	NU0851551	55
NU0851560V	NU0851560	55
NU0851570V	NU0851570	55
NU0851580V	NU0851580	55
NU0851590V	NU0851590	55
NU08515V	NU08515	55
NU0851600V	NU0851600	55
NU0851601V	NU0851601	55
NU0851651V	NU0851651	55
NU08516V	NU08516	55
NU0851701V	NU0851701	55
NU0851751V	NU0851751	55
NU08517V	NU08517	55
NU0851801V	NU0851801	55
NU0851851V	NU0851851	55
NU08518V	NU08518	55
NU0851901V	NU0851901	55
NU0851951V	NU0851951	55
NU08519V	NU08519	55
NU0851AV	NU0851A	55
NU0851BV	NU0851B	55

CODE	ID CODE	PAGE
NU0851CV	NU0851C	55
NU0851DV	NU0851D	55
NU0851EV	NU0851E	55
NU0851FV	NU0851F	55
NU0851GV	NU0851G	55
NU0851HV	NU0851H	55
NU0851IV	NU0851I	55
NU0851JV	NU0851J	55
NU0851KV	NU0851K	55
NU0851LV	NU0851L	55
NU0851MV	NU0851M	55
NU0851NV	NU0851N	55
NU0851OV	NU0851O	55
NU0851PV	NU0851P	55
NU0851QV	NU0851Q	55
NU0851RV	NU0851R	55
NU0851SP	NU0851SP	55
NU0851SV	NU0851S	55
NU0851TV	NU0851T	55
NU0851UV	NU0851U	55
NU0851VW	NU0851V	55
NU0851WV	NU0851W	55
NU0851XV	NU0851X	55
NU0851YV	NU0851Y	55
NU0851ZV	NU0851Z	55
NU0861	NU0861	19
NU0861SP	NU0861SP	57
NU1051	NU1051	19
NU1051SP	NU1051SP	57
NU1055	NU1055	19
NU1061	NU1061	19
NU1061SP	NU1061SP	57
NU1065	NU1065	19
NUL1061	NUL1061	20
NUL1061	NUL1061	57
NUPUTUK50	NUPUTUK50	20
NUPUTUK50SP	NUPUTUK50SP	57
NUT12	NUT 12	16
NUT12SP	NUT12SP	58
NUT12Y	NUT 12	16
NUT12YSP	NUT12YSP	58
NUT15	NUT 15	16
NUT15SP	NUT15SP	58
NUT15Y	NUT 15	16
NUT15YSP	NUT15YSP	58
NUT18	NUT 18	16
NUT18SP	NUT18SP	58
NUT18Y	NUT 18	16
NUT18YSP	NUT18YSP	58
NUT23	NUT 23	16
NUT23SP	NUT23SP	58
NUT23Y	NUT 23	16
NUT23YSP	NUT23YSP	58
NUWDK50	NUWDK50	20
NUWDK50SP	NUWDK50SP	58
NUWDU50	NUWDU50	20
NUWG051	NUWG051	20

CODE	ID CODE	PAGE
NUWDU50SP	NUWDU50SP	58
NUWG050	NUWG050	20
PADCABUR	PADCABUR	13
PADGRAPH	PADGRAPH	13
PADMUTHO	PADMUTHO	13
PEN025CAB	PEN025CAB	13
PEN035CAB	PEN035CAB	13
PEN035GRA	PEN035GRA	13
POMPASP	POMPASP	13
PT3017B	PT3017B	26
PT3017BA	PT3017BA	26
PT5217B	PT5217B	26
PT5217BA	PT5217BA	26
PT7017B	PT7017B	26
PT7017BA	PT7017BA	26
PTD022	PTD022	26
PTD022A	PTD022A	26
PTD225	PTD225	26
PTD225A	PTD225A	26
PTM	PTM	27
PTMS	PTMS	27
SH004	SHZ.1	19
SH004	SHZ/1/00	56
SH004SP	SH004SP	57
SH419	SHZ/1/19	56
SH4AA	SHZ/1/AA	56
SH4BB	SHZ/1/BB	56
SH4CC	SHZ/1/CC	56
SH4DD	SHZ/1/DD	56
SH4EE	SHZ/1/EE	56
SH4FF	SHZ/1/FF	56
SH4G1	SHZ/1/G1	56
SH4G2	SHZ/1/G2	56
SH4G2	SHZ/1/G3	56
SH4G4	SHZ/1/G4	56
SH4G5	SHZ/1/G5	56
SH4G6	SHZ/1/G6	56
SH4G7	SHZ/1/G7	56
SH4G8	SHZ/1/G8	56
SH4G9	SHZ/1/G9	56
SH4GG	SHZ/1/GG	56
SH4HH	SHZ/1/HH	56
SH4II	SHZ/1/II	56
SH4JJ	SHZ/1/JJ	56
SH4KK	SHZ/1/KK	56
SH4LL	SHZ/1/LL	56
SH4MM	SHZ/1/MM	56
SH4NN	SHZ/1/NN	56
SH400	SHZ/1/OO	56
SH4PP	SHZ/1/PP	56
SH4QQ	SHZ/1/QQ	56
SH4RR	SHZ/1/RR	56
SH4SS	SHZ/1/SS	56
SH4TT	SHZ/1/TT	56
SH4UU	SHZ/1/UU	56
SH4VV	SHZ/1/VV	56
SH4WW	SHZ/1/WW	56

CODE	ID CODE	PAGE
SH4XX	SHZ/1/XX	56
SH4YY	SHZ/1/YY	56
SH4ZZ	SHZ/1/ZZ	56
SN008	SNZ/4/00	56
SN819	SNZ/4/19	56
SPEEDRAIL	SPEEDRAIL	52
ST10512W	ST10512W	23
ST105W	ST105W	28
ST105Y	ST105Y	28
ST105AW	ST105AW	28
ST105AY	ST105AY	28
SWMP2	SWMP2	14
TA100060	TA100060	29
TA100060Y	TA100060Y	29
TA100090	TA100090	29
TA100090Y	TA100090Y	29
TA128AW	TA128AW	23
TA128AY	TA128AY	23
TA1517AW	TA1517AW	23
TA156AW	TA156AW	23
TA156AY	TA156AY	23
TA159AW	TA159AW	23
TA159AY	TA159AY	23
TA178AW	TA178AW	23
TA178AY	TA178AY	23
TA1808T	TA1808T	22
TA207AW	TA207AW	23
TA207AY	TA207AY	23
TA207S	TA207S	22
TAG209AY	TAG209AY	22
TAG209AW	TAG209AW	22
TA209Y	TA209Y	22
TA2080AM	TA2080AM	24
TA2080AW	TA2080AW	24
TA2080AY	TA2080AY	24
TA209AW	TA209AW	23
TA209AY	TA209AY	23
TA209SO	TA209SO	22
TA209W	TA209W	22
TA2715AM	TA2715AM	23
TA2715W	TA2715W	25
TA2715Y	TA2715Y	25
TA3070AM	TA3070AM	24
TA3070AW	TA3070AW	24
TA3070AY	TA30700AY	24
TA359W	TA359W	22
TA407AW	TA407AW	24
TA4090AM	TA4090AM	24
TA4090AW	TA4090AW	24
TA4090AY	TA4090AY	24
TA5015AM	TA5015AM	23
TA5015W	TA5015W	25
TA5015Y	TA5015Y	25
TA60100AM	TA60100AM	24
TA60100AW	TA60100AW	24
TA60100AY	TA60100AY	24
TA6715AM	TA6715AM	23

CODE	ID CODE	PAGE
TA6715W	TA6715W	25
TA6715Y	TA6715Y	25
TA80100AM	TA80100AM	24
TA80100AW	TA80100AW	24
TA80100AY	TA80100AY	24
TA1640AW	TA1640AW	24
TAG2715AW	TAG2715AW	24
TAG2715AY	TAG2715AY	24
TAG5015AW	TAG5015AW	24
TAG5015AY	TAG5015AY	24
TAG6715AW	TAG6715AW	24
TAG6715AY	TAG6715AY	24
TIM02	TIM02	27
TUB1200	TUB1200	17
TUB1201	TUB1201	17
TUB1202	TUB1202	17
TUB1203	TUB1203	17
TUB1204	TUB1204	17
TUB1205	TUB1205	17
TUB1500	TUB1500	17
TUB1501	TUB1501	17
TUB1502	TUB1502	17
TUB1503	TUB1503	17
TUB1504	TUB1504	17
TUB1505	TUB1505	17
TUB1800	TUB1800	17
TUB1801	TUB1801	17
TUB1802	TUB1802	17
TUB1803	TUB1803	17
TUB1804	TUB1804	17
TUB1805	TUB1805	17
TUB209	TUB209	22
TUB2300	TUB2300	17
TUB2301	TUB2301	17
TUB2302	TUB2302	17
TUB2303	TUB2303	17
TUB2304	TUB2304	17
TUB2305	TUB2305	17
TUB2715	TUB2715	27
TUB359	TUB359	22
TUB5015	TUB5015	27
TUB6715	TUB6715	27
TMC16040W	TMC16040W	18
TMC16040Y	TMC16040Y	18
UMCT3127	UMPU02510	43
UMCT3128	UMPI4060	43
UMCT3129	UMPI1525	43
UMCT3149	UMCT	43
UMCT3153	UMPU1625	43
UMCT3154	UMPU3550	43
VET100060	VET100060	29
VET100090	VET100090	29
VET2715	VET2715	25
VET5215	VET5215	25
VET6715	VET6715	25
WP30002	WP5-14	40
WP30003	WP5-16	40

CODE	ID CODE	PAGE
WP30005	WP75-14	40
WP30006	WP75-16	40
WP30009	WP1-14	40
WP30010	WP1-18	40
WP30013	WP15-14	40
WP30014	WP15-18	40
WP30016	WP25-14	40
WP30017	WP25-19	40
WP30019	WP40-16	40
WP30020	WP40-20	40
WP30022	WP60-20	40
WP30023	WP60-26	40
WP30024	WP100-21	40
WP30025	WP100-28	40
WP30026	WP160-22	40
WP30027	WP160-28	40
WP30028	WP250-29	40
WP30029	WP250-32	40
WP30030	WP350-30	40
WP30031	WP350-41	40
WP30032	WP500-40	40
WP30033	WP500-41	40
WP90001	WPD05/15	40
WP90002	WPD75/15	40
WP90003	WPD01/15	40
WP90004	WPD15/16	40
WP90005	WPD25/18	40
WP90006	WPD04/23	40
WP90007	WPD06	40
WP90008	WPD10	40
WPF15030/R	WPF5016	42
WPF15035/R	WPF5017	42
WPF15040/R	WPF5018	42
WPF15050/R	WPF5019	42
WPF15060/R	WPF5020	42
WPF25030/B	WPF5021	42
WPF25035/B	WPF5022	42
WPF25040/B	WPF5023	42
WPF25050/B	WPF5024	42
WPF25060/B	WPF5025	42
WPF40040/Y	WPF5026	42
WPF40050/Y	WPF5027	42
WPF40060/Y	WPF5028	42
WPF40080/Y	WPF5029	42
WPF60040/Y	WPF5030	42
WPF60050/Y	WPF5031	42
WPF60060/Y	WPF5032	42
WPF60080/Y	WPF5033	42
WPN10508	WPN0508	41
WPN10758	WPN0758	41
WPN11010	WPN1010	41
WPN11015	WPN10015	41
WPN11510	WPN1510	41
WPN11615	WPN16015	41
WPN12510	WPN2510	41
WPN12515	WPN25015	41
WPN14012	WPN4012	41

CODE	ID CODE	PAGE
WPN16012	WPN6012	41
WPO150100/R	WPO4025	41
WPO15035/R	WPO4020	41
WPO15040R	WPO4021	41
WPO15050/R	WPO4022	41
WPO150600/R	WPO4023	41
WPO15080/R	WPO4024	41
WPO250100/B	WPO4032	41
WPO25030/B	WPO4026	41
WPO25035/B	WPO4027	41
WPO25040/B	WPO4028	41
WPO25050/B	WPO4029	41
WPO25060/B	WPO4030	41
WPO25080/B	WPO4031	41
WPO4001000/Y	WPO4037	41
WPO400120/Y	WPO4038	41
WPO40040/Y	WPO4033	41
WPO40050/Y	WPO4034	41
WPO40060/Y	WPO4035	41
WPO40080/Y	WPO4036	41
WPO600100/Y	WPO4043	41
WPO600120/Y	WPO4044	41
WPO60040/Y	WPO4039	41
WPO60050/Y	WPO4040	41
WPO60060/Y	WPO4041	41
WPO60080/Y	WPO4042	41

NOTES:
