

# **Electronic Products for electrical panels**

**2014 edition**



UNI EN-ISO 9001



UNI EN-ISO 14001



**WARNING** If not specified, the technical data in this catalogue are typical and measured at 25°C (77°F), 230 Vac, Unom, Vdc and rated current; ripple is measured at 20 MHz with probe connected to 0.1  $\mu$ F. The technical data in this catalogue are typical and are not binding for Cabur and may be modified without prior notice, simply for production or improvement and/or evolution reason. Please contact our technical-commercial offices for any relevant confirmation or updates. For more informations visit our web site [www.cabur.eu](http://www.cabur.eu).

## Introduction

Cabur	page	6
Products range	page	8
Web site	page	9
Quality and environment	page	10
Standards and Directives	page	11

## Power supplies

Introduction	page	12
Quick selection table	page	14
CSD series - modular single-phase switching power supply - Domotic Power	page	16
CSF series - single-phase switching power supply - Cool Power	page	21
Single-phase switching power supply in IP65 housing	page	29
CSL series - single-phase switching power supply - Easy Power	page	30
CSW series - 1-2-3-phase switching power supply - Universal Power	page	35
CSG series - 3-phase switching power supply - Triple Power	page	39
CSA series - DC/DC switching converters	page	46
Power supply with 24 Vac input	page	49
Battery charger DC-UPS	page	53
Batteries holder module	page	56
CSC series - switching power supply with integrated battery charger	page	57
Accessory for power supplies redundant parallel connections	page	58
Motor brake controller	page	60

## Surge protection devices

Introduction	page	62
Pluggable surge protection devices	page	64

## Overcurrent protection devices

Introduction	page	65
Adjustable electronic overcurrent protection	page	66

## EMI Filters

Quick selection table	page	67
TDV series - 3-phase filter without neutral	page	68
TDS series - 3-phase filter without neutral	page	69
TDDS series - 3-phase filter without neutral	page	70
TDSS series - 3-phase filter without neutral	page	71
TYT series - 3-phase filter with neutral	page	72
TY series - compact three-phase filter with neutral	page	73
DK series - single-cell single-phase filter	page	74
DP series - double-cell single-phase filter	page	75

## Signal conditioners

Introduction	page	76
Quick selection table	page	78
Programmable analog signal converters	page	81
Analog signal converters	page	84
Passive galvanic isolators	page	87
Analog signal to threshold converter	page	88
Universal temperature converters	page	89
Temperature to threshold converter	page	90
Programmable converters for RTD sensor	page	91
Programmable converters for TC J and K sensor	page	92
Current to threshold converters	page	93
Current to analog signal converters	page	94



Frequency to analog signal converters .....	page 97
Auxiliary power supply for sensors and potentiometers .....	page 98
NPN and PNP signal inverter .....	page 99
<b>Electromechanical relay modules</b>	
Single relay quick selection table .....	page 100
R series - single relay DC input .....	page 101
CM series - single relay DC input .....	page 103
CM series - single relay AC input .....	page 106
CKR and CWRE series - Relay modules .....	page 108
Multiple relays quick selection table .....	page 111
24 V SPDT multiple relay modules .....	page 112
24 V DPDT multiple relay modules .....	page 116
24 V SPDT multiple relay modules with test button .....	page 119
110...120 V SPDT multiple relay modules .....	page 120
230 Vac SPDT multiple relay modules .....	page 121
CR and CRE series - super compact relay modules .....	page 122
PLC and CN interfaces quick selection table for .....	page 124
PLC Siemens S7 interfaces modules .....	page 125
PLC Telemecanique interfaces modules .....	page 128
<b>Solid state relay modules</b>	
Quick selection table .....	page 129
Single solid state relays modules .....	page 130
CKS series - modular single solid state relays modules .....	page 133
SPDT single solid state relays modules .....	page 135
Signal optoisolators .....	page 136
Multiple solid state relays modules .....	page 137
<b>Passive interface modules</b>	
Quick selection table .....	page 141
SUB-D / terminals interfaces .....	page 142
FLAT-cable / terminals interfaces .....	page 145
CCM series - components holder modules .....	page 147
CDM series - diodes holder modules .....	page 148
CLT series - LED testing module .....	page 150
CLP series - lamp testing module .....	page 151
<b>Accessories</b>	
Electronic circuit housing .....	page 152
Plug-in and screw type jumpers .....	page 154
Marking system .....	page 154
DIN rail clamp .....	page 156
Mounting rails .....	page 157
<b>Index</b> .....	page 159



• **Terminal blocks for electrical boards**

Terminal blocks for electrical panels, polyamide screw-clamp and spring-clamp terminal blocks, control terminal boards, high-current terminal boards, mobile terminal blocks, distribution terminal boards, 12-pole polyamide terminal boards

• **Electronic products for electrical boards**

power supplies, analog modules, relay modules, signal converters

• **Connection systems for photovoltaic plants**

Connectors, tools, cables, brackets for mounting of photovoltaic panels, string boxes, control units, monitoring systems, surge protection devices, diodes, fuse-holders

• **Industrial marking systems**

printing systems, tags and accessories for wire and terminal block identification, tags for contactors and buttons, modular strips for distribution panels, panel identification tags, labels and signboards



If you wish to receive complete and updated technical documentation on Cabur products, please send a request using the dedicated form that you can download **online on the [www.cabur.eu](http://www.cabur.eu) website**  
<http://www.cabur.eu/documentations>

or just fill in, and send the form below

**PLEASE SEND ME THE COMPREHENSIVE TECHNICAL DOCUMENTATION**

Surname ..... Name ..... Function .....

Company Name ..... Field of activity:  Distributor  Installer  Panel Builder  Other

Address ..... Town ..... Postcode .....

Telephone ..... Fax ..... E-mail .....

The data provided will be stored and used by Cabur srl in both paper and electronic form, both directly and through a reliable service provider, safely and with attention to privacy. At any time, you may exercise your rights pursuant to Italian Legislative Decree no. 196/2003, by writing to the data manager at the following address: Cabur srl, with offices in Altare (SV), Località Isola Grande 45 - Italy. I authorize the use of my data in accordance with Italian Legislative Decree no. 196/2003, as amended, for:

- The provision of goods and services (necessary to send documentation) YES  NO
- Statistical profiles and processing YES  NO
- Sending commercial communications YES  NO
- Communication of data to agencies and partner companies YES  NO

**I agree to my personal data being processed for the a.m. purposes.**  
Signature

\_\_\_\_\_

Date \_\_\_\_\_

**PLEASE PHOTOCOPY AND SEND BY FAX AT**

**+39 019 58999280**

Shortly after its foundation, back in 1952, Cabur became a leading manufacturer of electrical panel terminal blocks, by focusing on installers' needs and providing leading edge technical solutions that, in some cases, would become popular in the industry.

In particular, in our product design and manufacturing, we have pioneered a quality focus on raw materials, functionality, reliability over time, and respect for the environment. That is the reason why Cabur was granted Class 1E (Equipment for Nuclear Power Generating Stations) qualification as early as in 1985 and, in addition, the ISO 9001/UNI-EN 29001 (Quality) and ISO 14001 (Environment) certifications, as well as compliance to Atex standards for "Ex e" installations on the most important terminal block lines. The quality of Cabur products and services has been acknowledged by several international certification institutes.



UNI EN-ISO 14001



UNI EN-ISO 9001

## The headquarter

In 2006 Cabur invested in an advanced 15.000 sqm production site in Altare (SV). By doubling the production surface and increasing the staff with the recruitment of new people enabled the company to rationalise the production processes, logistics, and sales, and increase their efficiency.

Cabur develops and produces a wide range of products for the electric and electronic industry, based on its own projects, which are well known for their reliability even in extrem deployment conditions and are produced to satisfy the various and complex needs of installer and end users.



Località Isola Grande 45  
17041 Altare (SV)  
ITALY

Tel. +39 019 58999.1  
Fax +39 019 58999280  
e-mail: info@cabur.it

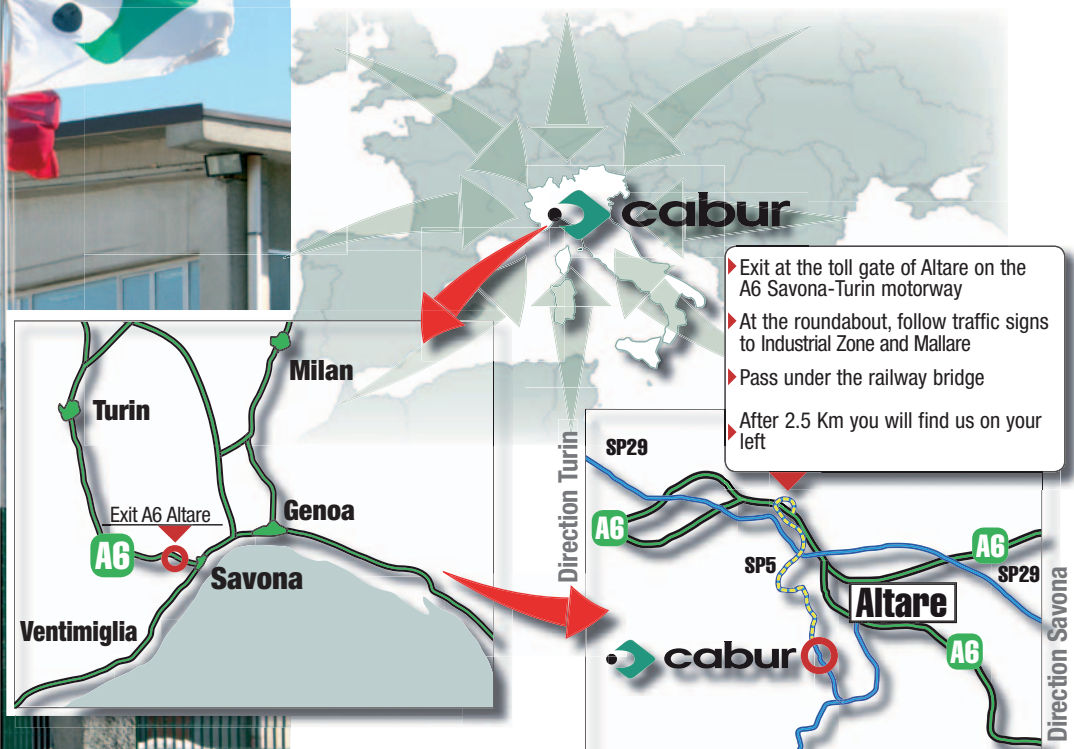



# Product range

With over 60 years of experience, Cabur develops and produces, by its own designs, a wide range of products for the electrical industry, providing the best in working conditions, in terms of operability and reliability.

Current production of:

- Terminal blocks for electrical boards
- Electronic products for electrical boards
- Installation products
- Products for photovoltaic installations
- Industrial marking systems

Fully meets users' varied and complex installation needs.

Our varied and diversified production represents the optimal synthesis of Cabur's long experience as partner of Italy's most important Industries and Research Laboratories, combined with foreign activities and collaboration, always with the aim of pinpointing and meeting users' installation needs.

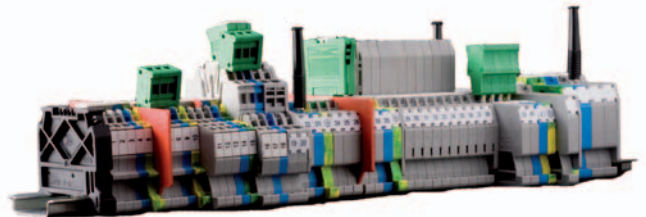
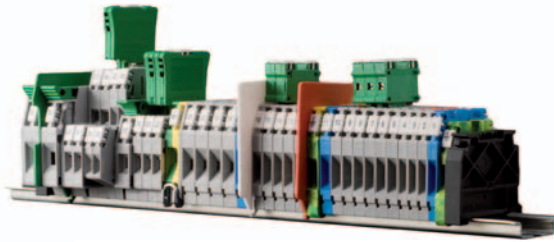

In particular as a result of a specific planning decision, products in our "standard" series are designed to meet the fundamental requirements of the most severe installation conditions and environments, thus avoiding to produce special product series for specific applications. This kind of planning has determined a clear qualitative improvement in the entire production, as well as a more streamlined and simplified product management, first of all to the advantage of the Distribution, which can guarantee to final Clients the most efficient service.



In addition to terminal blocks, Cabur product offering features a full range of electronic products for electric panels for plant and machine automation and process control. These products are designed for an easy deploy and for easy material management, thanks to the use of innovative and leading-edge technology.



The line of products for industrial marking completes the range with innovative printing solutions, labels for wires, terminal blocks and buttons, tags and modular strips for distribution boards.

## Highest ... ...mass produced quality

We guarantee top performance of our contacts and maximum flexibility of connection solutions. A full range of standard products for automation panels is available at all major Wholesalers. Full support is provided by Cabur sales force both in Italy and in over 30 countries abroad, as well as by our Engineers, in order to provide our clients with the best installation solutions.

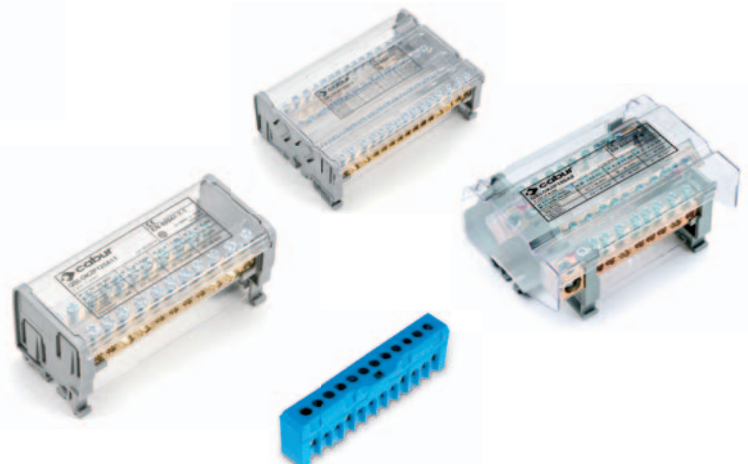

## The new [www.cabur.eu](http://www.cabur.eu) web site

On our web site, our customers and industry operators can always get up-to-date information on new products and sales offers. The data sheets of all Cabur products, including the items in this catalogue, are available online in electronic format, with a completely renewed data base structure, that can be consulted by its index or queried with an advanced research engine.

Moreover, on our web site you can:

- ask our specialists for technical information and application advice
- contact our sales staff and ask them for estimates
- download manuals and other technical literature
- get access to quality and compliance certificates
- look at our latest sales literature
- ask for free catalogues and brochures
- ... and much more.

By this newsletter, Cabur communicates also via e-mail its main innovations and commercial activities to all those who apply for it through the registration form.

In conclusion, Cabur web site ([www.cabur.eu](http://www.cabur.eu)) is the ideal tool to get real time information and contacts with our company.

# www.cabur.eu

## Real time information on our company, products, and certifications



In order to be promptly updated about the availability of new technical and commercial documentation, please register on the site and join the newsletter service.



# Quality and Environment

## ISO 9001 CSQ Certification

Until recently, Cabur "Quality" was simply recognised through the appreciation of its customers. This has allowed the company to become a leader in Italy in the design, production and distribution of "terminal blocks for electrical panels" and, more recently, to extend its products offering to the segment of "electronic products" with recognised reliability levels in both Italian and foreign markets. Obviously, this cannot be the result of improvisation, but of a constant organisation process begun back in 1985 with the definition and implementation of a Quality Assurance Programme based on ANSI N 45.2 (referred to the particularly severe nuclear environment) that has involved the entire structure of the Company and has made each function and worker responsible for quality standards. Since 1995, CSQ (international institute for the certification of business quality systems) has certified the Quality system designed and adopted by Cabur. The Quality system refers to the most complete and severe standard amongst UNI EN ISO 9000 series defining the requirements for Total Quality in Companies, that is ISO 9001, including the activities of Product Design, Development, Manufacturing and Customer Service. After the issue of the new Edition of the Standard (ISO 9001:2008), the whole Quality System has been revised and renewed to be fully compliant with the new regulations.



UNI EN-ISO 9001



## ISO 14001 CSQ Certification

In its continuous improvement process, CABUR has adopted an environmental management system since 2001, obtaining the international CSQ UNI EN 14001 recognition.

This goal represents a guarantee given of the respect Cabur has for the surrounding environment as well as a demonstration of the adoption of environmental safeguard rules and, additionally, a pledge for constant ecological improvement.

This kind of Certification is still quite uncommon in Italy; Cabur has nevertheless been able to achieve and add it to its corporate philosophy, which is always aimed at the anticipation, rather than to the passive adaptation, of those needs that are becoming more and more urgent and global. Environment is undoubtedly one of these issues and, anticipating many other companies, not only in Italy, Cabur firmly decided to adopt a system that monitors and prevents environmental risk, inherent to every stage of its manufacturing process. Operational procedures and other paper documentation were unified and harmonised with the running Quality Assurance System and the manual, becoming of both Quality and Environmental Management, is now a complete reference point. The Quality Assurance and Environmental Management Department is at your complete disposal to provide any further information and/or clarification on the entire Quality / Environment System and Customer Service. Cabur can provide you with a copy of both CSQ and EQNET certificates, or with a copy of the Quality and Environmental Management manual.



UNI EN-ISO 14001



# Standards and directives

## The 2011/65/CE Directive



**D**irective 2011/65/CE, known as RoHS 2, sets limits to the use of specific dangerous materials, listed in Annex II of the Directive, in electric and electronic devices.

The Directive applies exclusively to devices included in the following categories, as listed in attachment 1, i.e.:

1. Large appliances
2. Small appliances
3. IT and telecommunication appliances
4. Consumers' appliances
5. Lighting appliances
6. Electric and electronic tools.
7. Toys and devices for hobbies and sports
8. Medical devices
9. Monitors and control instruments, including industrial monitoring and control instruments
10. Vending machines
11. Other electric and electronic devices not listed in the above categories

### Cabur Products' compliance to RoHS Directive

Products like terminal blocks and connectors are not considered electric or electronic appliances; nevertheless, in consideration of the needs of those Customers deploying these products into appliances and devices which are subject to the Directive, Cabur has decided to review its production to make it RoHS compliant.

From 2006, with the introduction of the former 2002/95/CE Directive, we have been disposing of non-compliant items, completely eliminating – wherever possible – the dangerous material and substances listed in Annex II from components in our production, with a Zero Tolerance mindset. Those materials remain in limited quantity, well below the limits set by the Directive, only in those components that cannot be efficiently and effectively produced with available alternative technological solutions.

Further information and updates are always available on [www.cabur.eu](http://www.cabur.eu).

Our staff is available for further details both on our products and on the application of the RoHS Directive.

## CE Marking



**A**ll products in this catalogue meet all EU applicable standards when the catalogue was printed. Therefore, all required CE markings are placed on the products and on all product related documents.

Do not hesitate to contact our staff for any further information and/or explanations on Reference Standards. Cabur Customer Service can provide you with certificates of compliance to Reference Standards, type approvals, and CE markings.



# Cabur power house

**C**ontinues to renew and expand its range of power supplies for use in industrial automation and control of processes and systems, improving product performance and technology to meet the needs created by the continuing changes in applications and regulations.

**QUALITY AND SAFETY:** Cabur was the first Italian company to obtain UL508 Industrial Control Equipment certification for industrial automation processes and Hazardous Location Class 1 Div. 2 for processes in dangerous areas, as well as to have been certified as conforming to the Directives on Electric Safety. It also has been EMC certified by an accredited laboratory. All of these are indispensable for the CE certified label.

## INNOVATION AND RESEARCH:

- 1997 - Cabur is the first Italian company to produce switching power supplies for Din-rail with 90-264Vac/110-340Vdc universal input.
- 2001 - Cabur is the first Italian company to produce high efficiency power supplies with resonant technology (the 20A three-phase dissipates only 36W compared with over 75W for our competitors at the time).
- 2009 – With the new generation of power supplies in the catalogue, Cabur has further improved performance using “Synchronous Rectifier” technology, which reduces power dissipation and operating temperature to the minimum, an indispensable factor in minimizing the size of the power supplies, which are the smallest on the market. The lifespan of a power supply is halved by every +10°C increase in operating temperature. Hence, reducing operating temperature is fundamental to endurance and reliability, two objectives that can be achieved only by using circuit technology and next generation components. Thanks to this combination, Cabur has achieved output of over 94% (the new 20A three-phase dissipates only 28W, compared to the 50-75W in heat dissipation found in other products currently on the market).

**HIGH OVERLOAD CAPACITY:** the new power supplies have an overload capacity of over +50% for 5 seconds or for several minutes (please see the technical data), while maintaining stable output voltage even under these conditions.

**SYSTEM COMMUNICATIONS:** all the CSF, CSG, and CSW Series models are provided with “intelligent” alarm contacts that commutate when the output voltage drops below -10% of the nominal value. This allows the controls to activate automated or emergency procedures to reduce machine stoppage, production losses, and the risk to safety.

**TOTAL PROTECTION:** all models are provided with output protection against overload short circuiting, overtemperature, and overvoltage, both for input and output. Input for the three-phase models includes the Active Surge Suppressor – Inrush Current Limiter, which avoids malfunctioning in the case of overvoltage generated by commutation of loads or malfunctions on industrial networks, where the value can reach 3-4 times the network voltage, with a duration of 1.3ms (Regulation VDE-0160), which can be destructive for the input components. This increases reliability, especially in networks subject to power surges and power malfunctions.

**SHORT CIRCUIT** and overload protection: this serves to protect the power supply from malfunctions due to overloading and overheating of the components. This function can be designed by starting with different application needs, with varying practical results and costs. In automated applications, the operating conditions and the nature of the loads can vary greatly and are only partially known to the power supply designer. Power supplies for automated processes need to meet a number of requirements. They need to be protected from overcurrent, but at the same time they need to be able to supply loads which call for a high peak current, working at temperatures of at least 45° C, according to regulations, and sometimes higher, in critical ventilation situations and guaranteeing high reliability and acceptable costs.

The overcurrent protection must support the high peak currents required by loads such as filament lamps (cold, they make a short circuit), capacitive loads such as dc/dc converters and filter condensators (when these switch on they are seen as a short-circuit for a few tenths of a ms) or inductive loads (engines in dc, electromagnets, etc.) which at peak require currents from 5 – 30 times their nominal power. Frequently, all these loads must be started up at the same time. The peak current must be provided for a sufficient duration to “start” the load, which can go from a few tenths of a ms up to 5s.

With high power power supplies, which power various loads protected from overcurrent, the capacity to provide overcurrent is indispensable to guarantee selectivity in protection interventions. This is because it allows the fuse of the malfunctioning load to be “burned” before the electronic protection of the power supply intervenes, disconnecting the output and hence the entire system.

## ELECTRONIC OVERLOAD POWER SUPPLY PROTECTION CAN BE OBTAINED USING VARIOUS TECHNIQUES:

- switch off the output as soon as possible: this is cost effective but doesn't allow for either start up of heavy loads nor for protection selectivity for various loads.
- constant power protection: if the allowed overload is sufficiently high, it is possible to start up heavy loads. However, if the condition continues, the power supply will continue to operate in overload and with a high thermal stress level. Hiccup protection: combines the advantages of the techniques described above, while limiting the disadvantages because it allows over +50-100% of the overload for at least 5 seconds, and then switches off output for a longer break. In this way, the peak power necessary for heavy load peaks is obtained while component heating is decreased, as they can cool off during the break. Hiccup protection with high overcurrent output, for durations from 200 ms to over 5 sec., has been proven to satisfy the new requirements established by the Machinery Directive EN 60204-1.

Real operating temperature: the operating temperature range for all Cabur models is between -20 and +50°C at full load without derating (see technical data), certified in accordance with the rigorous UL508 standard. The project takes into consideration the ambient temperature, allowed overcurrent, and overcurrent duration when determining component size, and is always more than the 45°C required by the standards for electric panels. Ambient temperature is a fundamental reference parameter, because this influences not only performance, but also component operating temperature and power supply duration.

**HOLD UP TIME:** this is the time in which the power supply output supplies nominal voltage at nominal load. This performance is important because it limits the cases in which machine/system stoppage can occur due to voltage “holes” in the network. EMC standards establish that Hold Up time must be at least 10ms. For all Cabur power supplies, Hold Up time is greater than that required by the official standards, which ensures better operational consistency in networks with frequent voltage holes.

**MTBF:** this figure should be taken with a care, because it is the result of theoretical calculations that are easy to manipulate. For example, if we know that the mortality rate for 25 year old men is 0.1%/year, the resultant MTBF, calculated in accordance with SN29500 – IEC 61709, would be 800 years. Obviously, this result is highly unrealistic. The significant piece of information is the “life expectancy,” which for men averages about 75 years – less spectacular but more realistic. The same reasoning can be applied to electronic products for which, in accordance with the calculation methods, we can use an MTBF of 750,000 hours (85 years), or a life expectancy of about 70,000 hours (7.9 years, on average). The second estimate is less optimistic, but is without doubt closer to reality. As a consequence, data published regarding MTBF must be interpreted based on the credibility of the calculation methods used. In addition to the values according to SN 29500, Cabur has also chosen to declare those according to the MIL HDBKn217F standards, which are much stricter.

**CUSTOM POWER SUPPLIES:** Cabur designs and produces “custom” power supplies on request to meet the requirements of regulations and the high demanding applications. Furthermore our laboratory offers technical documentation and the measures which prove the conformity of the products with the directives on Electric Safety and Electromagnetic Compatibility, besides the necessary technical support to define the product characteristics on the basis of the client's needs and our own experience.

**THE ENVIRONMENT AND ROHS CONFORMANCE:** Cabur was one of the first Italian companies to obtain the International Environmental Certificate UNI EN ISO 14001, certified by CSQ for ecologically compatible treatment of all the materials used in our production.



## General Notes

**PARALLEL AND REDUNDANT PARALLEL CONNECTION:** all Cabur power supplies can be connected in parallel to combine the power of two or more power supplies. In addition, models that already include an output separation diode (ORing diode) are available for use with redundant parallels (please see the related item in the catalogue). We recommend adjusting the outputs of all the power supply units to the same voltage (tolerance  $\pm 50$  mV), applying the same calibration load, before connecting them in parallel. We also recommend using power supply units of the same model. If it is necessary to connect two power supplies without internal diodes in redundant parallel, the connection must be completed as in fig. 1.

**CONNECTION IN SERIES:** all Cabur power supplies can have their outputs connected in series to double the voltage (see fig. 2) or to obtain dual voltage output, for example with  $\pm 12$ V or  $\pm 24$  V (see fig. 3). We recommend that you use power supplies of the same model and an anti-parallel diode, of an appropriate size to resist the maximum current of the power supply.

**POWER SIGNAL OK:** this is found on all CSF, CSG, and CWS models. The 1A/30Vdc contact commutates when output voltage falls below the threshold of -10% of nominal voltage, in the case of a short circuit on the output line or an overload that exceeds the specifications, or due to network failure.

**100-340Vdc POWER SUPPLY:** available for certain models (please see technical data), which respect the following:

- power supply of 110...127 Vdc, reduces output current by 25%
- min. voltage allowed 100 Vdc, max 340 for single phase, 280...775 Vdc for single/two-phase, 564...775Vdc for three-phase (please see technical data)
- respect input polarity as indicated in the instructions.

### Note for power supplies with secondary input from a transformer

**INSULATION:** this series of power supply units is not insulated.

**TYPE OF USE:** they are suitable for use in PELV (one pole of the Protective Extra Low Voltage earthed) and SELV (Safety Extra Low Voltage, no pole earthed). The transformer used must have double or reinforced isolation in accordance with CEI 14.6 / EN 60742.

In the case of use in PELV circuits, only earth one pole of the 24 Vdc of the power supply unit.

In the case of use in SELV circuits, do not earth the input earth terminal.

**Earthing one pole of the secondary of the transformer and the 24Vdc of the power supply would damage the power supply.**

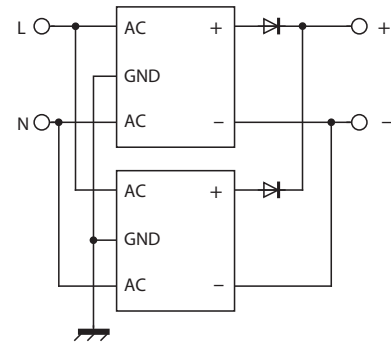

figure 1

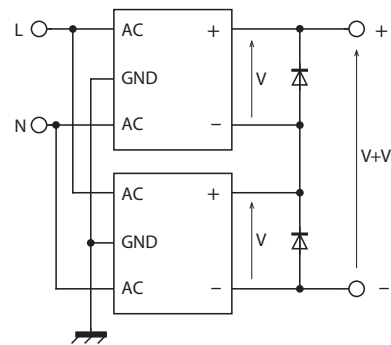

figure 2

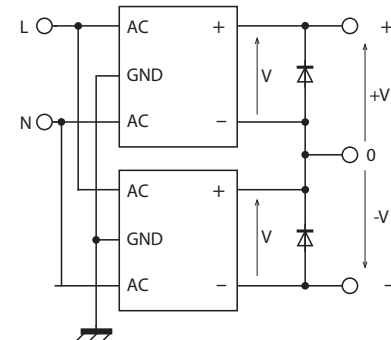

figure 3

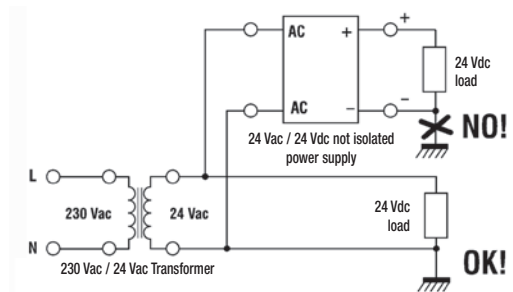

figure 4

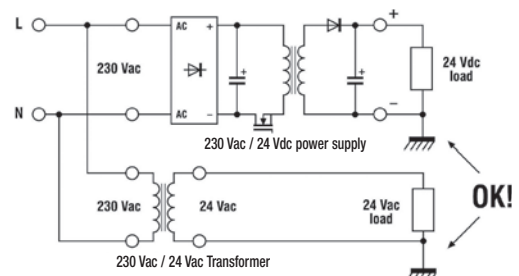

figure 5

# Power supply quick selection table

These tables allow you to quickly select only the items, then check if all product's technical data meet your application requirements.

## Single-phase switching power supply - Cool Power series

Output voltage	Output current	Input voltage	Notes	Type	Cat. No.	Page
10...15 Vdc	1.5...1 A	90...264 Vac / 100...320 Vdc	(1) (8) (9)	CSF30B	XCSF30B	22
12...15 Vdc	6 A	90...264 Vac / 100...345 Vdc	(1) (7) (8) (9)	CSF85B	XCSF85B	23
12...15 Vdc	16 A	120 Vac / 230 Vac	(2) (7) (8)	CSF240B	XCSF240B	25
24 Vdc	1.2 A	90...264 Vac / 100...320 Vdc	(1) (9)	CSF30C	XCSF30C	22
24 Vdc	3.5 A	90...264 Vac / 100...345 Vdc	(1) (7) (9)	CSF85C	XCSF85C	23
24 Vdc	3.5 A	90...264 Vac / 100...345 Vdc	(1) (6) (7) (9)	CSF85CP	XCSF85CP	23
24 Vdc	5 A	90...264 Vac / 100...345 Vdc	(1) (7) (9)	CSF120C	XCSF120C	24
24 Vdc	5 A	90...264 Vac / 100...345 Vdc	(1) (6) (7) (9)	CSF120CP	XCSF120CP	24
24 Vdc	10 A	120 Vac / 230 Vac	(2) (7)	CSF240C	XCSF240C	25
24 Vdc	10 A	120 Vac / 230 Vac	(2) (6) (7)	CSF240CP	XCSF240CP	25
24 Vdc	20 A	120 Vac / 230 Vac	(2) (6) (7)	CSF500C	XCSF500C	27
48 Vdc	2.5 A	90...264 Vac / 100...345 Vdc	(1) (6) (7)	CSF120DP	XCSF120DP	24
48 Vdc	5 A	120 Vac / 230 Vac	(2) (6) (7)	CSF240DP	XCSF240DP	25
48 Vdc	10 A	120 Vac / 230 Vac	(2) (6) (7)	CSF500D	XCSF500D	27
72 Vdc	3.5 A	120 Vac / 230 Vac	(2) (6) (7) (8)	CSF240G	XCSF240G	26
72 Vdc	6.7 A	120 Vac / 230 Vac	(2) (6) (7) (8)	CSF500G	XCSF500G	28

## Single-phase switching power supply - Easy Power series

Output voltage	Output current	Input voltage	Notes	Type	Cat. No.	Page
24 Vdc	3.5 A	90...264 Vac	(1)	CSL85C	XCSL85C	31
24 Vdc	5 A	90...264 Vac	(1)	CSL120C	XCSL120C	32
24 Vdc	10 A	120 Vac / 230 Vac	(2)	CSL240C	XCSL240C	33
24 Vdc	20 A	230 Vac	-	CSL481C	XCSL481C	34

## Single-phase switching power supply - Domotic Power series

Output voltage	Output current	Input voltage	Notes	Type	Cat. No.	Page
5...15 Vdc	3...1.5 A	90...264 Vac / 100...345 Vdc	(1) (8) (9)	CSD30E	XCSD30E	18
±12...±15	0.6 A	90...264 Vac / 100...345 Vdc	(1) (8) (9)	CSD30F	XCSD30F	18
12 Vdc	1.2 A	90...264 Vac / 100...315 Vdc	(1) (9)	CSD15B	XCSD15B	17
12...15 Vdc	3.5...3 A	90...264 Vac / 100...345 Vdc	(1) (8) (9)	CSD50B	XCSD50B	19
24 Vdc	0.6 A	90...264 Vac / 100...315 Vdc	(1) (9)	CSD15C	XCSD15C	17
24 Vdc	1.2 A	90...264 Vac / 100...345 Vdc	(1) (9)	CSD30C	XCSD30C	18
24 Vdc	3 A	90...264 Vac / 100...345 Vdc	(1) (9)	CSD70C	XCSD70C	20

## Single phase, 2-phase and 3-phase switching power supply - Universal Power series

Output voltage	Output current	Input voltage	Notes	Type	Cat. No.	Page
12...15 Vdc	8...7 A	1-2x 230-400-500 Vac	(1) (3) (7) (8) (9)	CSW121B	XCSW121B	36
12...15 Vdc	16...15 A	1-2-3x 230-400-500 Vac	(1) (3) (4) (7) (8) (9)	CSW241B	XCSW241B	37
24 Vdc	5 A	1-2x 230-400-500 Vac	(1) (3) (7) (9)	CSW121C	XCSW121C	36
24 Vdc	10 A	1-2-3x 230-400-500 Vac	(1) (3) (4) (7) (9)	CSW241C	XCSW241C	37
24 Vdc	20 A	1-2-3x 230-400-500 Vac	(1) (3) (4) (7) (9)	CSW481C	XCSW481C	38
48 Vdc	2.5 A	1-2x 230-400-500 Vac	(1) (3) (6) (7) (9)	CSW121DP	XCSW121DP	36
48 Vdc	5 A	1-2-3x 230-400-500 Vac	(1) (3) (4) (6) (7) (9)	CSW241DP	XCSW241DP	37
48 Vdc	10 A	1-2-3x 230-400-500 Vac	(1) (3) (4) (7) (9)	CSW481D	XCSW481D	38
72 Vdc	3.3 A	1-2-3x 230-400-500 Vac	(1) (3) (4) (6) (7) (8) (9)	CSW241G	XCSW241G	37
72 Vdc	6 A	1-2-3x 230-400-500 Vac	(1) (3) (4) (7) (8) (9)	CSW481G	XCSW481G	38

# Power supply quick selection table

These tables allow you to quickly select only the items, then check if all product's technical data meet your application requirements.

## 3-phase switching power supply - Triple Power series

Output voltage	Output current	Input voltage	Notes	Type	Cat. No.	Page
24 Vdc	20 A	3x 400-500 Vac	(4) (7)	CSG481C	XCSG481C	40
24 Vdc	20 A	3x 400-500 Vac	(4) (7)	CSG500C	XCSG500C	41
24 Vdc	30 A	3x 400-500 Vac	(4) (7)	CSG720C	XCSG720C	42
24 Vdc	40 A	3x 400-500 Vac	(4) (7)	CSG960C	XCSG960C	43
24 Vdc	100 A	3x 400-500 Vac	(4) (6) (7) (8)	CSG2401C	XCSG2401C	44
48 Vdc	10 A	3x 400-500 Vac	(4) (6) (7)	CSG500D	XCSG500D	41
48 Vdc	15 A	3x 400-500 Vac	(4) (6) (7)	CSG720D	XCSG720D	42
48 Vdc	20 A	3x 400-500 Vac	(4) (6) (7)	CSG960D	XCSG960D	43
48 Vdc	50 A	3x 400-500 Vac	(4) (6) (7) (8)	CSG2401D	XCSG2401D	44
72 Vdc	6.7 A	3x 400-500 Vac	(4) (6) (7) (8)	CSG500G	XCSG500G	41
72 Vdc	13.3 A	3x 400-500 Vac	(4) (6) (7) (8)	CSG960G	XCSG960G	43
72 Vdc	33 A	3x 400-500 Vac	(4) (6) (7) (8)	CSG2401G	XCSG2401G	45
170 Vdc	14 A	3x 400-500 Vac	(4) (6) (7) (8)	CSG2401R	XCSG2401R	45

## Power supply with IP65 protection degree

Output voltage	Output current	Input type	Input voltage	Notes	Type	Cat. No.	Page
24 Vdc	5 A	single-phase	90...264 Vac / 100...345 Vdc	(1) (7) (9)	CSF565	XCSF565	29

## Power supply with input from transformer

Output voltage	Output current	Input type	Input voltage	Notes	Type	Cat. No.	Page
1.2...24 Vdc	1.5 A	from transformer	9...26 Vac	(5) (8)	CL1R	XCL1R	51
1.2...24 Vdc	5 A	from transformer	9...26 Vac	(5) (8)	CL5R	XCL5R	51

## Filtered power supply with not stabilised output

Output voltage	Output current	Input type	Input voltage	Notes	Type	Cat. No.	Page
12...24 Vdc	1 A	from transformer	9...20 Vac	(5)	AR1	XAR1	52
12...24 Vdc	6 A	from transformer	9...20 Vac	(5)	AR6	XAR6	52

## DC/DC isolated converter

Input voltage	Output voltage	Output current	Notes	Type	Cat. No.	Page
12 Vdc	24 Vdc	5 A	(9)	CSA120BC	XCSA120BC	46
12 Vdc	48 Vdc	2.5 A	(9)	CSA120BD	XCSA120BD	46
24 Vdc	12...15 Vdc	7 A	(8) (9)	CSA120CB	XCSA120CB	46
24 Vdc	24 Vdc	5 A	(9)	CSA120CC	XCSA120CC	46
48 Vdc	12...15 Vdc	8 A	(8) (9)	CSA120DB	XCSA120DB	47
48 Vdc	24 Vdc	5 A	(9)	CSA120DC	XCSA120DC	47
110 Vdc	24 Vdc	10 A	(6) (7) (9)	CSA240FC	XCSA240FC	48

(All single phase wide range power supply can be feed at 110 Vdc)

### Note

- (1) wide range single-phase input
- (2) double range single-phase input
- (3) two-phase input
- (4) three-phase input

- (5) input from a secondary of a transformer
- (6) redundant version
- (8) with failure contact (power good)
- (8) with adjustable output
- (9) DC/DC converter

# Modular switching power supply CSD series

## DOMOTIC POWER

Single phase switching power supplies with output power up to 70W for civil and industrial automation applications.

The housings have the standard dimensions for installation in DIN modular panels, and are **optimized for the deployment in the field of building automation**. The high performance and compact size make them an excellent solution for low-depth electrical panels.

The high efficiency and low dissipated power save energy and increase the life of the components.

### Suggested uses

- Applications in industrial automation
- Applications in civil automation
- General applications in systems fit into small remote panels

### Main features

- The 90...264 Vac and 110...370 Vdc input makes them suitable for use on all power supply lines.
- These power supplies are Insulation Class 2, thus they don't require grounding, which reduces costs and times during installation into remote panels, surveillance and monitoring systems.
- Their high efficiency reduces energy consumption and working temperature and allows their use in small panels.
- Their backup power allows the supply of continuous current at least +50% above the rated value ensuring safety and reliability.
- Dimensioned power supply and surge protection supplying breakaway starting currents 150% above the rated value required by heavy loads.
- Thermal protection prevents faults caused by prolonged overload at high ambient temperatures.
- Their internal components' high efficiency and excellent ventilation offer small dimensions and IP20 protection against accidental contacts in compliance with IEC529.



### Short circuit and overload

*Designed to provide load start up current required by medium loads*

### Compact size

*Ideal solution for electrical panels with low profile*

### Power boost

*The output power supplied reaches up to 130% of the rated value*

### High Efficiency

*Designed to save energy and reduce working temperature*

### 90...264 Vac and 110...350 Vdc input wide range

*Suitable in single phase voltage networks*

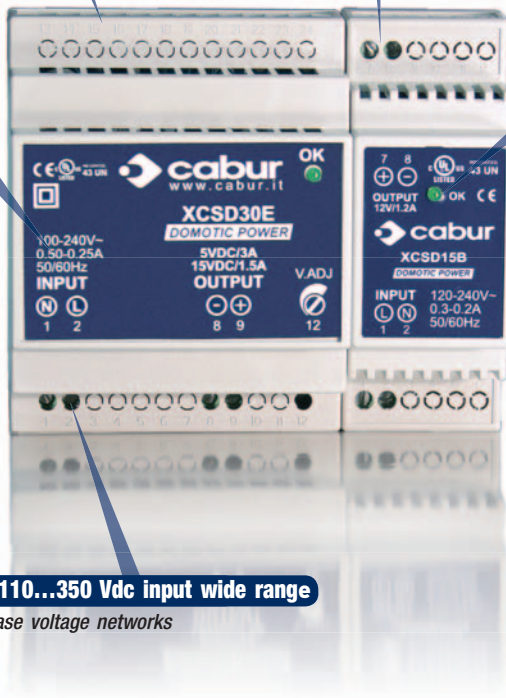

# Single-phase switching power supply 120-230 Vac output power 15 W

- Single-phase input 90...264 Vac and DC 100...315 Vdc
- Short circuit, overload, over temperature, input overvoltage protections
- Isolation Class 2, no grounding needed
- Compact dimensions
- Suitable for applications in SELV and PELV circuits

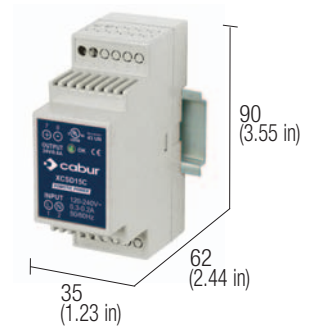

## NOTES

- The depth dimension includes the DIN rail clamp.
- (2) Over 50°C (122°F) apply a derating: C version: -0.015 A/°C; B version: -0.03 A/°C.
- (3) Overload and short circuit current depends on the total line resistance

## BLOCK DIAGRAM

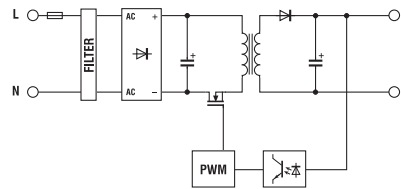

## VERSIONS

- Output 24 Vdc 0.6 A
- Output 24 Vdc 0.6 A redundant version
- Output 12 Vdc 1.2 A
- Output 48 Vdc 0.3 A

Cod. XCSD15C	Cod. XCSD15B
CSD15C	-
-	CSD15B
-	-

## INPUT TECHNICAL DATA

- Input rated voltage
- Frequency
- Current @ nominal Iout (Iin 120 / 230 Vac)
- Inrush peak current
- Power factor
- Internal protection fuse
- External protection on AC line

<b>120-230 Vac</b> (range 90...264 Vac / 100...315 Vdc)
47...63 Hz
0.3 A / 0.16 A ± 10%
< 5 A
> 0.6
T 1 A replaceable
circuit breaker: 2 A - C characteristic - fuse: T 2 A

## OUTPUT TECHNICAL DATA

- Output rated voltage
- Output adjustable range
- Continuous current
- Overload limit
- Short circuit peak current
- Load regulation
- Ripple @ nominal ratings
- Hold up time @ Iin (Iin 120 / 230 Vac)
- Overload / short circuit protections
- Status display
- Alarm contact threshold
- Parallel connection
- Redundant parallel connection

24 Vdc ± 1%	12 Vdc ± 0.5 Vdc
—	—
<b>0.6 A @ 50°C</b> (2)	<b>1.2 A @ 50°C</b> (2)
1.08 A (3)	2.16 A (3)
—	—
< 1%	< 1%
≤ 30 mVpp	≤ 30 mVpp
>12 ms / >20 ms	>12 ms / >20 ms
hiccup at the overload limit with auto reset / over temperature protection	
"DC OK" green LED	
—	—
possible	possible
possible with external ORing diode	possible with external ORing diode

## GENERAL TECHNICAL DATA

- Efficiency (Iin 120 / 230 Vac)
- Dissipated power (Iin 120 / 230 Vac)
- Operating temperature range
- Input/output isolation
- Input/ground isolation
- Output/ground isolation
- Standard/approvals
- EMC Standards
- MTBF @ 25°C @ nominal ratings
- Overvoltage category/Pollution degree
- Protection degree
- Connection terminal
- Housing material
- Approx. weight
- Mounting information

>85% / >87%
2,5 W / 2,2 W
-20...+60°C, with derating over 50°C / over temperature protection (2)
3 kVac / 60 s SELV output
class 2 without PE connection
class 2 without PE connection
EN50178, EN61558, EN60950, IEC950, UL508
EN61000-6-2, EN61000-6-4, EN61000-4-2, EN61000-4-3, EN61000-4-4, EN61000-4-5, EN61000-4-6, EN61000-4-11
>750'000 h acc. to SN 29500 / >250'000 h acc. to MIL Std. HDBK 217F
II / 2
IP 20 IEC 529, EN60529
2.5 mm <sup>2</sup> fixed screw type
UL94V-0 plastic material
130 g (5.12 oz)
vertical on rail, allow 10 mm spacing between adjacent components

## MOUNTING ACCESSORIES

- Mounting rail type according to IEC60715/TH35-7.5
- Mounting rail type according to IEC60715/G32

## PR/3/AC, PR/3/AC/ZB, PR/3/AS, PR/3/AS/ZB



# Single-phase switching power supply 120-230 Vac output power 30 W

- Single-phase input 90...264 Vac and DC 100...345 Vdc
- Short circuit, overload, over temperature, input overvoltage protections
- Isolation Class 2, no grounding needed
- Compact dimensions
- Suitable for applications in SELV and PELV circuits

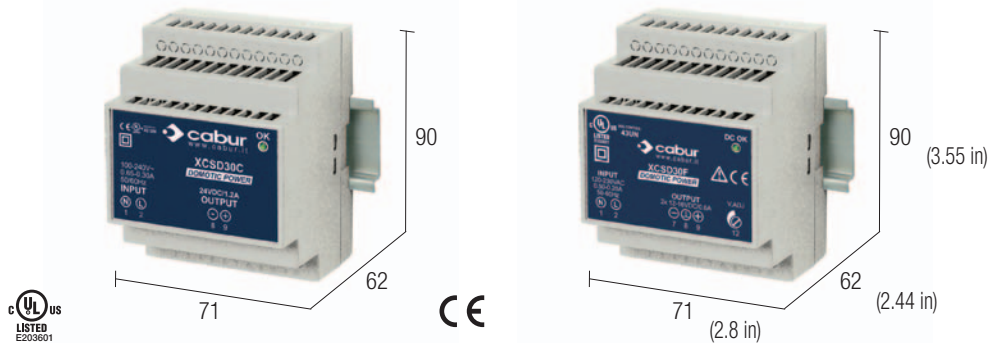

## NOTES

- The depth dimension includes the DIN rail clamp.
- (2) Over 50°C (122°F) apply a derating: C and F versions: -0.03 A/°C; E version: -0.08...-0.04 A/°C.
- (3) Overload and short circuit current depends on the total line resistance.
- (4) Output current depends on the output voltage: 3.3A @ 5Vdc, 2A @ 9Vdc, 2.2A @ 12Vdc, 1.5A @ 15Vdc.

## BLOCK DIAGRAM

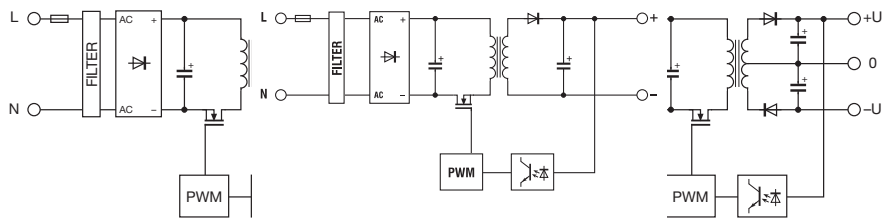

## VERSIONS

- Output 24 Vdc 1.2 A
- Output 24 Vdc 1.2 A redundant version
- Output 5...15 Vdc 3.3...1.5 A
- Output ±12...±15 Vdc 0.6 A

## INPUT TECHNICAL DATA

- Input rated voltage
- Frequency
- Current @ nominal Iout (Uin 120 / 230 Vac)
- Inrush peak current
- Power factor
- Internal protection fuse
- External protection on AC line

## OUTPUT TECHNICAL DATA

- Output rated voltage
- Output adjustable range
- Continuous current
- Overload limit
- Short circuit peak current
- Load regulation
- Ripple @ nominal ratings
- Hold up time @ In (Uin 120 / 230 Vac)
- Overload / short circuit protections
- Status display
- Alarm contact threshold
- Parallel connection
- Redundant parallel connection

## GENERAL TECHNICAL DATA

- Efficiency (Uin 120 / 230 Vac)
- Dissipated power (Uin 120 / 230 Vac)
- Operating temperature range
- Input/output isolation
- Input/ground isolation
- Output/ground isolation
- Standard/approvals
- EMC Standards
- MTBF @ 25°C @ nominal ratings
- Overvoltage category/Pollution degree
- Protection degree
- Connection terminal
- Housing material
- Approx. weight
- Mounting information

## MOUNTING ACCESSORIES

- Mounting rail type according to IEC60715/TH35-7.5
- Mounting rail type according to IEC60715/G32

## Cod. XCSD30C

CSD30C

## Cod. XCSD30E

-

## Cod. XCSD30F

CSD30F

120-230 Vac (range 90...264 Vac / 100...345 Vdc)			
47...63 Hz			
0.55 A / 0.28 A ± 10%	0.45 A / 0.25 A ± 10%		0.4 A / 0.2 A ± 10%
< 13 A	< 13 A		< 13 A
> 0.6			
T 2 A replaceable			
circuit breaker: 3 A - C characteristic - fuse: T 3.15 A			

24 Vdc ± 1%	5...15 Vdc	±12...±15 Vdc
—	5...15 Vdc	±12...±15 Vdc
1.2 A @ 50°C (2)	3.3...1.5 A @ 50°C (2)(4)	2x0.6 A @ 50°C (2)
1.6 (3)	4 A (3)	>2x0.8 A (3)
—	—	—
< 1%	< 1%	< 1%
≤ 50 mVpp	≤ 50 mVpp	≤ 50 mVpp
>30 ms / >60 ms	>50 ms / >100 ms	>50 ms / >100 ms
hiccup at the overload limit with auto reset / over temperature protection		
"DC OK" green LED		
—	—	—
possible	possible	possible
possible with external ORing diode	possible with external ORing diode	possible with external ORing diode

>85% / >87%	>87% / >89%	>87% / >89%
5,1 W / 4,3 W	4,0 W / 3,4 W	1,6 W / 1,3 W
-20...+60°C, with derating over 50°C / over temperature protection (2)		
3 kVac / 60 s SELV output		
class 2 without PE connection		
class 2 without PE connection		
EN50178, EN61558, EN60950, IEC950, UL508		
EN61000-6-2, EN61000-6-4, EN61000-4-2, EN61000-4-3, EN61000-4-4, EN61000-4-5, EN61000-4-6, EN61000-4-11		
>750'000 h acc. to SN 29500 / >250'000 h acc. to MIL Std. HDBK 217F		
II / 2		
IP 20 IEC 529, EN60529		
2.5 mm <sup>2</sup> fixed screw type		
UL94V-0 plastic material		
200 g (7.06 oz)		
vertical on rail, allow 10 mm spacing between adjacent components		

PR/3/AC, PR/3/AC/ZB, PR/3/AS, PR/3/AS/ZB

# Single-phase switching power supply 120-230 Vac output power 50 W

- Single-phase input 90...264 Vac and DC 100...345 Vdc
- Short circuit, overload, over temperature, input overvoltage protections
- Isolation Class 2, no grounding needed
- Compact dimensions
- Suitable for applications in SELV and PELV circuits

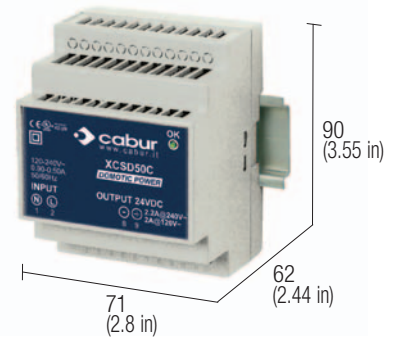

## NOTES

- The depth dimension includes the DIN rail clamp.
- (2) With 100...127 Vdc input voltage, constant output power and  $T_a > 45^\circ\text{C}$ , the output current must be derated by 25%
- (3) Over  $50^\circ\text{C}$  ( $122^\circ\text{F}$ ) apply a derating:  
C version:  $-0.06\text{ A}/^\circ\text{C}$ ; B version:  $-0.085\text{ A}/^\circ\text{C}$ .
- (4) Overload and short circuit current depends on the total line resistance.

## BLOCK DIAGRAM

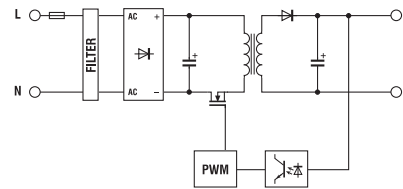

## VERSIONS

- Output 24 Vdc 2.2 A
- Output 24 Vdc 2.2 A redundant version
- Output 12...15 Vdc 3.5...3 A
- Output 48 Vdc 1.1 A

## INPUT TECHNICAL DATA

Input rated voltage	120-230 Vac (range 90...264 Vac / 100...345 Vdc) (2)
Frequency	47...63 Hz
Current @ nominal Iout (Uin 120 / 230 Vac)	0.9 A / 0.5 A $\pm 10\%$
Inrush peak current	< 15 A
Power factor	> 0.6
Internal protection fuse	T 2 A replaceable
External protection on AC line	circuit breaker: 3 A - C characteristic - fuse: T 3.15 A

## OUTPUT TECHNICAL DATA

Output rated voltage	12...15 Vdc
Output adjustable range	12...15 Vdc
Continuous current	3.5...3 A @ $50^\circ\text{C}$ (3)
Overload limit	4.37...3.75 A (4)
Short circuit peak current	—
Load regulation	< 1%
Ripple @ nominal ratings	$\leq 50\text{ mVpp}$
Hold up time @ In (Uin 120 / 230 Vac)	>20 ms / >40 ms
Overload / short circuit protections	hiccup at the overload limit with auto reset / over temperature protection
Status display	"DC OK" green LED
Alarm contact threshold	—
Parallel connection	possible
Redundant parallel connection	possible with external ORing diode

## GENERAL TECHNICAL DATA

Efficiency (Uin 120 / 230 Vac)	>85% / >88%
Dissipated power (Uin 120 / 230 Vac)	7.9 W / 6.1 W
Operating temperature range	$-20\text{...}+60^\circ\text{C}$ , with derating over $50^\circ\text{C}$ / over temperature protection (3)
Input/output isolation	3 kVac / 60 s SELV output
Input/ground isolation	class 2 without PE connection
Output/ground isolation	class 2 without PE connection
Standard/approvals	EN50178, EN61558, EN60950, IEC950, UL508
EMC Standards	EN61000-6-2, EN61000-6-4, EN61000-4-2, EN61000-4-3, EN61000-4-4, EN61000-4-5, EN61000-4-6, EN61000-4-11
MTBF @ $25^\circ\text{C}$ @ nominal ratings	>750'000 h acc. to SN 29500 / >250'000 h acc. to MIL Std. HDBK 217F
Overvoltage category/Pollution degree	II / 2
Protection degree	IP 20 IEC 529, EN60529
Connection terminal	2.5 mm <sup>2</sup> fixed screw type
Housing material	UL94V-0 plastic material
Approx. weight	200 g (7.06 oz)
Mounting information	vertical on rail, allow 10 mm spacing between adjacent components

## MOUNTING ACCESSORIES

- Mounting rail type according to IEC60715/TH35-7.5
- Mounting rail type according to IEC60715/G32

## Cod. XCSD50B

—		
	CSD50B	—

## 120-230 Vac (range 90...264 Vac / 100...345 Vdc) (2)

47...63 Hz
0.9 A / 0.5 A $\pm 10\%$
< 15 A
> 0.6
T 2 A replaceable
circuit breaker: 3 A - C characteristic - fuse: T 3.15 A

## 12...15 Vdc

12...15 Vdc
3.5...3 A @ $50^\circ\text{C}$ (3)
4.37...3.75 A (4)
—
< 1%
$\leq 50\text{ mVpp}$
>20 ms / >40 ms
hiccup at the overload limit with auto reset / over temperature protection
"DC OK" green LED
—
possible
possible with external ORing diode

## >85% / >88%

7.9 W / 6.1 W
$-20\text{...}+60^\circ\text{C}$ , with derating over $50^\circ\text{C}$ / over temperature protection (3)
3 kVac / 60 s SELV output
class 2 without PE connection
class 2 without PE connection
EN50178, EN61558, EN60950, IEC950, UL508
EN61000-6-2, EN61000-6-4, EN61000-4-2, EN61000-4-3, EN61000-4-4, EN61000-4-5, EN61000-4-6, EN61000-4-11
>750'000 h acc. to SN 29500 / >250'000 h acc. to MIL Std. HDBK 217F
II / 2
IP 20 IEC 529, EN60529
2.5 mm <sup>2</sup> fixed screw type
UL94V-0 plastic material
200 g (7.06 oz)
vertical on rail, allow 10 mm spacing between adjacent components

## PR/3/AC, PR/3/AC/ZB, PR/3/AS, PR/3/AS/ZB

—
---

# Single-phase switching power supply 120-230 Vac output power 70 W

- Single-phase input 90...264 Vac and DC 100...345 Vdc
- Short circuit, overload, over temperature, input overvoltage protections
- Isolation Class 2, no grounding needed
- Compact dimensions
- Suitable for applications in SELV and PELV circuits

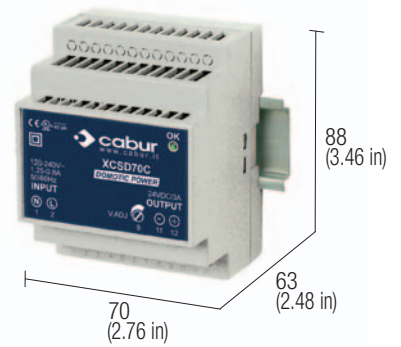

## NOTES

- The depth dimension includes the DIN rail clamp.
- (2) With 100...127 Vdc input voltage, constant output power and  $T_a > 45^\circ\text{C}$ , the output current must be derated by 25%.
- (3) Over  $50^\circ\text{C}$  ( $122^\circ\text{F}$ ) apply a derating: C version:  $-0.15\text{ A}/^\circ\text{C}$ .
- (4) Overload and short circuit current depends on the total line resistance.

## BLOCK DIAGRAM

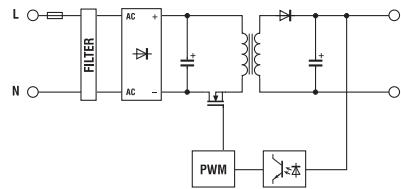

## VERSIONS

- Output 24 Vdc 3 A
- Output 24 Vdc 3 A redundant version
- Output 12...15 Vdc 5...4 A
- Output 48 Vdc 1.5 A

## Cod. XCSD70C

### CSD70C

-	-	-
---	---	---

## INPUT TECHNICAL DATA

- Input rated voltage
- Frequency
- Current @ nominal Iout (Uin 120 / 230 Vac)
- Inrush peak current
- Power factor
- Internal protection fuse
- External protection on AC line

<b>120-230 Vac</b> (range 90...264 Vac / 100...370 Vdc) (2)
47...63 Hz
1.25 A / 0.8 A $\pm$ 10%
< 15 A
> 0.6
T 2 A not replaceable
circuit breaker: 4 A C characteristic - fuse: T 3.15 A

## OUTPUT TECHNICAL DATA

- Output rated voltage
- Output adjustable range
- Continuous current
- Overload limit
- Short circuit peak current
- Load regulation
- Ripple @ nominal ratings
- Hold up time @ In (Uin 120 / 230 Vac)
- Overload / short circuit protections
- Status display
- Alarm contact threshold
- Parallel connection
- Redundant parallel connection

<b>24 Vdc</b>		
24...27.5 Vdc		
<b>3 A @ 55°C</b> (3)		
4 A (4)		
—		
< 1%		
$\leq$ 60 mVpp		
>15 ms / >30 ms		
hiccup at the overload limit with auto reset / over temperature protection		
"DC OK" green LED		
—		
possible		
possible with external ORing diode		

## GENERAL TECHNICAL DATA

- Efficiency (Uin 120 / 230 Vac)
- Dissipated power (Uin 120 / 230 Vac)
- Operating temperature range
- Input/output isolation
- Input/ground isolation
- Output/ground isolation
- Standard/approvals
- EMC Standards
- MTBF @ 25°C @ nominal ratings
- Overvoltage category/Pollution degree
- Protection degree
- Connection terminal
- Housing material
- Approx. weight
- Mounting information

>87% / >89%		
10,8 W / 8,9 W		
-20...+60°C, with derating over 55°C (3)		
3 kVac / 60 s SELV output		
class 2 without PE connection		
class 2 without PE connection		
EN50178, EN61558, EN60950, IEC950, UL508		
EN61000-6-2, EN61000-6-4, EN61000-4-2, EN61000-4-3, EN61000-4-4, EN61000-4-5, EN61000-4-6, EN61000-4-11		
>750'000 h acc. to SN 29500 / >250'000 h acc. to MIL Std. HDBK 217F		
II / 2		
IP 20 IEC 529, EN60529		
2.5 mm <sup>2</sup> fixed screw type		
UL94V-0 plastic material		
250 g (8.82 oz)		
vertical on rail, allow 10 mm spacing between adjacent components		

## MOUNTING ACCESSORIES

- Mounting rail type according to IEC60715/TH35-7.5
- Mounting rail type according to IEC60715/G32

<b>PR/3/AC, PR/3/AC/ZB, PR/3/AS, PR/3/AS/ZB</b>
---



# Switching power supply GSF series

## COOL POWER

**DIN-rail single phase switching power supplies**, specifically designed for applications in industrial automation panels and process control panels. They can deliver +60% to +80% of the nominal current for a sustained period keeping the output voltage constant; the alarm contact is controlled by a voltage threshold, and it switches when the voltage drops under 90% of the rated output value.

**Thanks to these features and to the numerous international certifications, this series of power supplies allows engineers to meet all the requirements of the new EN 60204-1 Machinery Directive**, to enable the protection devices connected to the output to trigger quickly, safely and above all selectively, thus ensuring continuity of service to the other parts of the system.

### Suggested uses

- Applications in industrial automation requiring high levels of efficiency and reliability
- Applications requiring selectivity of surge protection devices on DC lines.
- Application in machinery automation requiring high levels of reliability in terms of control and safety voltage
- Applications in process control
- Heavy duty uses
- Applications in civil automation

### Main features

- The 90...264 Vac and 110...370 Vdc input makes them suitable for use on all power supply lines.
- Threshold alarm contact warning when the voltage drops 90% below the rated value.
- Versions with integrated Oring diode for redundant parallel connections, avoiding the use of external devices and reducing dimensions and installation costs.
- Their high efficiency reduces energy consumption and components' operating temperature allowing their use in small panels and under severe ambient conditions.
- Their backup power allows the supply of current and voltage at least +60-80% above the rated value for a few minutes ensuring safety and reliability.
- The output voltage may be adjusted and the output is protected against the input of surges coming from the DC line and caused by inductive loads.
- The output is equipped with double electronic protection devices preventing dangerous voltages which may damage powered components in the event of internal faults.
- Thermal protection prevents faults in the event of prolonged overloads at high ambient temperatures.
- Their design ensures excellent ventilation to internal components, small dimensions and IP20 protection against accidental contacts in compliance with IEC529.
- Thanks to their high efficiency and excellent ventilation, they are the smallest devices available on the market.

### Special power supplies for engines in DC, Brushless, and relative drives

New 48Vdc and 72-85Vdc models have been introduced, designed to reliably power engines in DC. They:

- Supply peak power equal to even 4-5 times the nominal current, which is required by the engine during the peak phase
- Have an output stage protected from overvoltage generated by the engines and drives during braking, which could otherwise cause malfunctions or cause the power supply to lose control over output voltage stability
- Provide output voltage at 48Vdc, and 72-85Vdc. By increasing the voltage of the engine power supply, the same power can be obtained at lower current, with notable advantages for performance, engine construction, cables, and drives.



### Extremely compact dimensions

They are among the smallest on the market, optimising the use of space in the panel without compromising performance

### Power boost

The output power reaches 120% of the nominal value for several minutes, up to 160% during an overload, and up to 300% in the event of a short-circuit, to enable the protection devices connected to the output to trigger quickly, safely and selectively, without the use of additional modules

### Short circuit and overload

Designed to provide load start up current required by heavy loads

### High Efficiency

Designed to save energy and reduce working temperature

### Integrated smart alarm contact

Activated when output voltage decreases below 90% of rated value

### 90...264 Vac and 110...350 Vdc input wide range

Suitable in all single phase supply voltage networks



# Single-phase switching power supply 120-230 Vac output power 30 W

- Single-phase input 90...264 Vac and DC 100...320 Vdc
- Short circuit, overload, over temperature protection
- Isolation Class 2, no grounding needed
- Compact dimensions
- Suitable for applications in SELV and PELV circuits

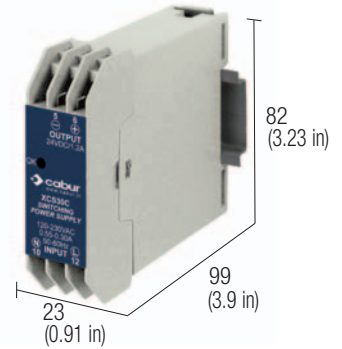

## NOTES

The depth dimension includes the DIN rail clamp.

- (1) Version available upon request; for information call our sales department, local agent or representative
- (2) With 100...127 Vdc input voltage, constant output power and  $T_a > 45^\circ\text{C}$ , the output current must be derated by 25%
- (3) Over  $50^\circ\text{C}$  ( $122^\circ\text{F}$ ) apply a derating: C version:  $-0.03 \text{ A}/^\circ\text{C}$ ; B version:  $-0.038 \text{ A}/^\circ\text{C}$ ; F version:  $-0.013 \text{ A}/^\circ\text{C}$
- (4) Overload and short circuit current depends on the total line resistance.

## BLOCK DIAGRAM

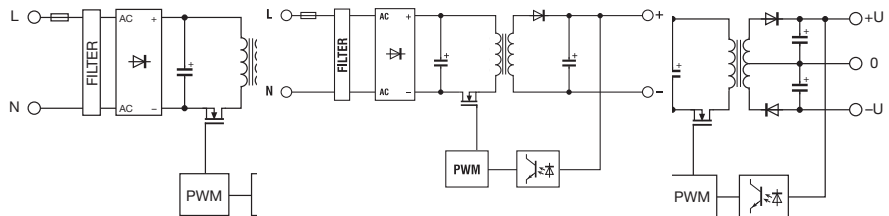

## VERSIONS

- Output 24 Vdc 1.2 A
- Output 10...15 Vdc 1.5 A
- Output  $\pm 12... \pm 15$  Vdc 0.5 A

Cod. XCSF30C

Cod. XCSF30B

Cod. XCSF30F

CSF30C (1)

CSF30B (1)

CSF30F (1)

## INPUT TECHNICAL DATA

- Input rated voltage
- Frequency
- Current @ nominal Iout (Iin 120 / 230 Vac)
- Inrush peak current
- Power factor
- Internal protection fuse
- External protection on AC line

120-230 Vac (range 90...264 Vac / 100...320 Vdc) (2)

	47...63 Hz
0.55 A / 0.3 A $\pm 10\%$	0.35 A / 0.2 A $\pm 10\%$
	< 25 A
	> 0.60
	T 1,25 A not replaceable
	circuit breaker: 2 A - C characteristic - fuse: T 2 A

## OUTPUT TECHNICAL DATA

- Output rated voltage
- Output adjustable range
- Continuous current
- Overload limit
- Short circuit peak current
- Load regulation
- Ripple @ nominal ratings
- Hold up time @ In (Iin 120 / 230 Vac)
- Overload / short circuit protections
- Status display
- Alarm contact threshold
- Parallel connection
- Redundant parallel connection

24 Vdc  $\pm 1\%$

12 - 15 Vdc

$\pm 12 \pm 15$  Vdc

—

10...15 Vdc

$\pm 12... \pm 15$  Vdc

1.2 A @  $50^\circ\text{C}$  (3)

1.5...1 A @  $50^\circ\text{C}$  (3)

0.5 A @  $50^\circ\text{C}$  (3)

1.4 A (4)

1.7...1.2 A (4)

0.8...0.6 A (4)

—

—

—

< 1%

$\leq 50 \text{ mVpp}$

>10 ms / >30 ms

hiccup at the overload limit with auto reset

"DC OK" green LED

—

possible

possible with external ORing diode

## GENERAL TECHNICAL DATA

- Efficiency (Iin 120 / 230 Vac)
- Dissipated power (Iin 120 / 230 Vac)
- Operating temperature range
- Input/output isolation
- Input/ground isolation
- Output/ground isolation
- Standard/approvals
- EMC Standards
- MTBF @  $25^\circ\text{C}$  @ nominal ratings
- Overvoltage category/Pollution degree
- Protection degree
- Connection terminal
- Housing material
- Approx. weight
- Mounting information

>86% / >87%

4.7 W / 4.3 W

$-20...+60^\circ\text{C}$ , with derating over  $50^\circ\text{C}$  (3)

3 kVac / 60 s SELV output

class 2 without PE connection

class 2 without PE connection

EN50178, EN61558, EN60950, IEC950, UL508, UL60950

EN61000-6-2, EN61000-6-4, EN61000-4-2, EN61000-4-3, EN61000-4-4, EN61000-4-5, EN61000-4-6, EN61000-4-11

>750'000 h acc. to SN 29500 / >250'000 h acc. to MIL Std. HDBK 217F

II / 2

IP 20 IEC 529, EN60529

2.5 mm<sup>2</sup> fixed screw type

UL94V-0 plastic material

140 g (4.94 oz)

vertical on rail, allow 10 mm spacing between adjacent components

## MOUNTING ACCESSORIES

- Mounting rail type according to IEC60715/TH35-7.5
- Mounting rail type according to IEC60715/G32

PR/3/AC, PR/3/AC/ZB, PR/3/AS, PR/3/AS/ZB

# Single-phase switching power supply 120-230 Vac output power 85 W

- Single-phase input 90...264 Vac and DC 100...345 Vdc
- Short circuit, overload, over temperature, input and output overvoltage protections
- High outrush current to guarantee downstream overcurrent protections selectivity and to start-up heavy loads
- Failure contact for Uout -10%
- Compact dimensions
- Suitable for applications in SELV and PELV circuits

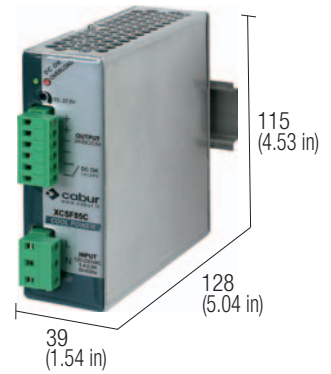

## NOTES

- The depth dimension includes the DIN rail clamp.
- (2) With 100...127 Vdc input voltage, constant output power and  $T_a > 45^\circ\text{C}$ , the output current must be derated by 25%
- (3) Over  $45^\circ\text{C}$  ( $113^\circ\text{F}$ ) apply derating: CSF3-CSF3P:  $-0.06\text{ A}/^\circ\text{C}$  for version C, CP and CPH;  $-0.10\text{ A}/^\circ\text{C}$  for version B
- (4) For this peak current, the output voltage does not drop more than 10% of the nominal value, but the current value, provided by the power supply also depends on the total line resistance.
- (5) Available ATEX version (IIIG Ex nA nC IIC T4 Gc X), for order adds "-EX" to the code, example XCSF85C-EX.

## BLOCK DIAGRAM

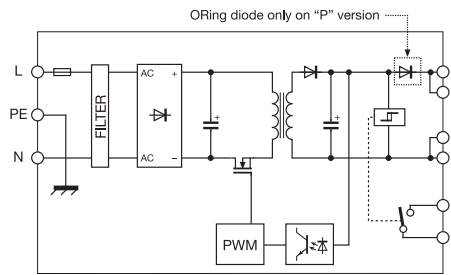

## VERSIONS

- Output 24 Vdc 3.5 A
- Output 24 Vdc 3.5 A redundant version
- Output 12...15 Vdc 6 A
- Output 48 Vdc 1.8 A

## INPUT TECHNICAL DATA

- Input rated voltage
- Frequency
- Current @ nominal Iout (Uin 120 / 230 Vac)
- Inrush peak current
- Power factor
- Internal protection fuse
- External protection on AC line

Cod. XCSF85C      Cod. XCSF85CP      Cod. XCSF85B

CSF85C	CSF85CP	CSF85B
--------	---------	--------

**120-230 Vac** (range 90...264 Vac / 100...345 Vdc) (2)

47...63 Hz

1.6 A / 0.9 A  $\pm 10\%$

< 20 A

> 0.65

T 2 A replaceable

circuit breaker: 4 A - C characteristic - fuse: T 4 A

## OUTPUT TECHNICAL DATA

- Output rated voltage
- Output adjustable range
- Continuous current
- Overload limit
- Short circuit peak current
- Load regulation
- Ripple @ nominal ratings
- Hold up time @ In (Uin 120 / 230 Vac)
- Overload / short circuit protections
- Status display
- Alarm contact threshold
- Parallel connection
- Redundant parallel connection

	24 Vdc	12...15 Vdc
Output rated voltage	23...27.5 Vdc	12...15 Vdc
Continuous current	<b>3.5 A @ 50°C</b> (3)	<b>6 A @ 50°C</b> (3)
Overload limit	6 A for >30 s with Uout >90% Un (4)	9 A for >30 s with Uout >90% Un (4)
Short circuit peak current	10 A for 50 ms (4)	10 A for 50 ms (4)
Load regulation	< 1%	< 1%
Ripple @ nominal ratings	$\leq 70\text{ mVpp}$	$\leq 30\text{ mVpp}$
Hold up time @ In (Uin 120 / 230 Vac)	>20 ms / >70 ms	>15 ms / >60 ms
Overload / short circuit protections	hiccup at the overload limit with auto reset / over temperature protection	
Status display	"DC OK" green LED / "DC OK" alarm contact/ "Overload" red LED	
Alarm contact threshold	21.6 Vdc	10.8 Vdc
Parallel connection	possible	possible
Redundant parallel connection	possible with external ORing diode	factory provided with internal ORing diode

## GENERAL TECHNICAL DATA

- Efficiency (Uin 120 / 230 Vac)
- Dissipated power (Uin 120 / 230 Vac)
- Operating temperature range
- Input/output isolation
- Input/ground isolation
- Output/ground isolation
- Standard/approvals
- EMC Standards
- MTBF @ 25°C @ nominal ratings
- Overvoltage category/Pollution degree
- Protection degree
- Connection terminal
- Housing material
- Approx. weight
- Mounting information

Efficiency (Uin 120 / 230 Vac)	>86% / >90%	>83% / >87%
Dissipated power (Uin 120 / 230 Vac)	14 W / 10 W	17 W / 13 W
Operating temperature range	-20...+60°C, with derating over 50°C / over temperature protection (3)	
Input/output isolation	3 kVac / 60 s SELV output	
Input/ground isolation	1.5 kVac / 60 s	
Output/ground isolation	0.5 kVac / 60 s	
Standard/approvals	EN50178, EN61558, EN60950, IEC950, UL508, UL60950	
EMC Standards	EN61000-6-2, EN61000-6-4, EN61000-4-2, EN61000-4-3, EN61000-4-4, EN61000-4-5, EN61000-4-6, EN61000-4-11	
MTBF @ 25°C @ nominal ratings	>500'000 h acc. to SN 29500 / >150'000 h acc. to MIL Std. HDBK 217F	
Overvoltage category/Pollution degree	II / 3	
Protection degree	IP 20 IEC 529, EN60529	
Connection terminal	2.5 mm <sup>2</sup> pluggable screw type	
Housing material	aluminium	
Approx. weight	400 g (14.12 oz)	
Mounting information	vertical on rail, allow 10 mm spacing between adjacent components	

## MOUNTING ACCESSORIES

- Mounting rail type according to IEC60715/TH35-7.5
- Mounting rail type according to IEC60715/G32

PR/3/AC, PR/3/AC/ZB, PR/3/AS, PR/3/AS/ZB

# Single-phase switching power supply 120-230 Vac output power 120 W

- Single-phase input 90...264 Vac and DC 100...345 Vdc
- Short circuit, overload, over temperature, input and output overvoltage protections
- High outrush current to guarantee downstream overcurrent protections selectivity and to start-up heavy loads
- Failure contact for Uout -10%
- Compact dimensions
- Suitable for applications in SELV and PELV circuits

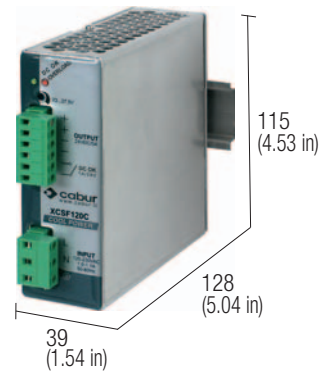

(5)



## NOTES

- The depth dimension includes the terminal blocks and the DIN clamp.
- (2) With 100...127 Vdc input voltage, constant output power and  $T_a > 45^\circ\text{C}$ , the output current must be derated by 25%
- (3) Over  $45^\circ\text{C}$  ( $113^\circ\text{F}$ ) apply a derating  $-0.08 \text{ A}/^\circ\text{C}$  for version C, CP and CPH;  $-0.12 \text{ A}/^\circ\text{C}$  for version B;  $-0.05 \text{ A}/^\circ\text{C}$  for version DP;
- (4) For this peak current, the output voltage does not drop more than 10% of the nominal value, but the current value, provided by the power supply also depends on the total line resistance.
- (5) Available ATEX version (II3G Ex nA nC IIC T4 Gc X), for order adds "-EX" to the code, example XCSF120C-EX.
- (6) article available till seal-out

## BLOCK DIAGRAM

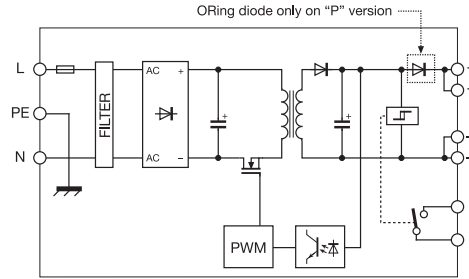

Special version for DC motors

## VERSIONS

- Output 24 Vdc 5 A
- Output 24 Vdc 5 A redundant version
- Output 12...15 Vdc 7 A
- Output 48 Vdc 2.5 A

Cod. XCSF120C	Cod. XCSF120CP	Cod. XCSF120B	Cod. XCSF120DP
CSF120C	CSF120CP	CSF120B (6)	CSF120DP

## INPUT TECHNICAL DATA

Input rated voltage	120-230 Vac (range 90...264 Vac / 100...345 Vdc) (2)
Frequency	47...63 Hz
Current @ nominal lout (Uin 120 / 230 Vac)	1.9 A / 1.1 A $\pm 10\%$
Inrush peak current	< 20 A
Power factor	> 0.65
Internal protection fuse	T 3.15 A replaceable
External protection on AC line	circuit breaker: 4 A - C characteristic - fuse: T 4 A

## OUTPUT TECHNICAL DATA

	24 Vdc	12...15 Vdc	48 Vdc
Output rated voltage	23...27.5 Vdc	12...15 Vdc	45...55 Vdc
Output adjustable range			
Continuous current	5 A @ 45°C (3)	7 A @ 45°C (3)	2.5 A @ 45°C (3)
Overload limit	8 A for >30 s with 90% Un (4)	8 A for >30 s with 90% Un (4)	8 A for >30 s with 90% Un (4)
Short circuit peak current	15 A for 50 ms (4)	15 A for 50 ms (4)	7.5 A for 50 ms (4)
Load regulation	< 1%	< 1%	< 1%
Ripple @ nominal ratings	$\leq 30 \text{ mVpp}$	$\leq 40 \text{ mVpp}$	$\leq 30 \text{ mVpp}$
Hold up time @ In (Uin 120 / 230 Vac)	>17 ms / >72 ms	>24 ms / >80 ms	>16 ms / >81 ms
Overload / short circuit protections	hiccup at the overload limit with auto reset / over temperature protection		
Status display	"DC OK" green LED / "DC OK" alarm contact/ "Overload" red LED		
Alarm contact threshold	<21.6 Vdc	<10.8 Vdc	<43.2 Vdc
Parallel connection	possible	possible	possible
Redundant parallel connection	possible with external ORing diode	factory provided with internal ORing diode	factory provided with internal ORing diode

## GENERAL TECHNICAL DATA

Efficiency (Uin 120 / 230 Vac)	>86% / >90%	>85% / >89%	>86% / >90%
Dissipated power (Uin 120 / 230 Vac)	19 W / 13 W	21 W / 15 W	20 W / 13 W
Operating temperature range	-20...+60°C, with derating over 45°C / over temperature protection (3)		
Input/output isolation	3 kVac / 60 s SELV output		
Input/ground isolation	1.5 kVac / 60 s		
Output/ground isolation	0.5 kVac / 60 s		
Standard/approvals	EN50178, EN61558, EN60950, IEC950, UL508, UL60950		
EMC Standards	EN61000-6-2, EN61000-6-4, EN61000-4-2, EN61000-4-3, EN61000-4-4, EN61000-4-5, EN61000-4-6, EN61000-4-11		
MTBF @ 25°C @ nominal ratings	>500'000 h acc. to SN 29500 / >150'000 h acc. to MIL Std. HDBK 217F		
Overvoltage category/Pollution degree	II / 3		
Protection degree	IP 20 IEC 529, EN60529		
Connection terminal	2.5 mm <sup>2</sup> pluggable screw type		
Housing material	aluminium		
Approx. weight	400 g (14.12 oz)		
Mounting information	vertical on rail, allow 10 mm spacing between adjacent components		

## MOUNTING ACCESSORIES

- Mounting rail type according to IEC60715/TH35-7.5
- Mounting rail type according to IEC60715/G32

PR/3/AC, PR/3/AC/ZB, PR/3/AS, PR/3/AS/ZB



# Single-phase switching power supply 120-230 Vac output power 240 W

- Single-phase input 120 and 230 Vac
- Short circuit, overload, over temperature, input and output overvoltage protections
- High outrush current to guarantee downstream overcurrent protections selectivity and to start-up heavy loads
- Failure contact for Uout -10%
- Compact dimensions
- Suitable for applications in SELV and PELV circuits

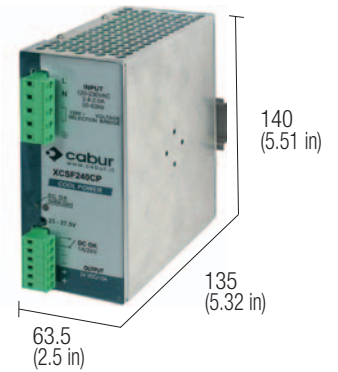

## NOTES

The depth dimension includes the terminal blocks and the DIN clamp.

- (2) Double input selectable with external jumper, DC supply allow only between 300 and 345 Vdc  
 (3) Over 45°C (113°F) apply a derating: -0.17 A/°C for version C, CP and CPH; -0.27 A/°C for version B; -0.08 A/°C for version DP;  
 (4) For this peak current, the output voltage does not drop more than 10% of the nominal value, but the current value, provided by the power supply also depends on the total line resistance.  
 (5) Available ATEX version (II3G Ex nA nC IIC T4 Gc X), for order adds "-EX" to the code, example XCSF240C-EX.

## BLOCK DIAGRAM

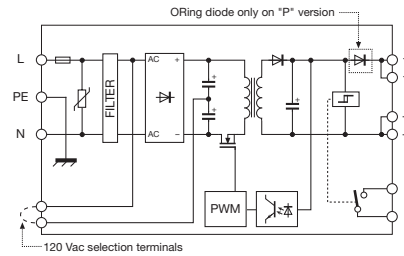

Special version for DC motors

VERSIONS	Cod. XCSF240C	Cod. XCSF240CP	Cod. XCSF240B	XCSF240DP
Output 24 Vdc 10 A	CSF240C			
Output 24 Vdc 10 A redundant version		CSF240CP		
Output 12...15 Vdc 16 A			CSF240B	
Output 48 Vdc 5 A redundant version				CSF240DP
INPUT TECHNICAL DATA	120 - 230 Vac (range 90...132 Vac / 185...264 Vac / 300...345 Vdc) (2)			
Input rated voltage	47...63 Hz			
Frequency	3.5 A / 1.8 A ± 10%			
Current @ nominal lout (Uin 120 / 230 Vac)	< 35 A			
Current @ nominal lout (Uin 120 / 230 Vac)	> 0.6			
Current @ nominal lout (Uin 120 / 230 Vac)	T 6.3 A replaceable			
Current @ nominal lout (Uin 120 / 230 Vac)	circuit breaker: 10 A - C characteristic - fuse: T 10 A			
OUTPUT TECHNICAL DATA	24 Vdc	12...15 Vdc	12...15 Vdc	48 Vdc
Output rated voltage	23...27.5 Vdc	12...15 Vdc	12...15 Vdc	45...55 Vdc
Output adjustable range	10 A @ 45°C (3)	16 A @ 45°C (3)	16 A @ 45°C (3)	5 A @ 45°C (3)
Output rated current	15 A for >30 s	24 A for >30 s	24 A for >30 s	7.5 A for >30 s
Output rated current	with Uout >90% Un (4)	with Uout >90% Un (4)	with Uout >90% Un (4)	with Uout >90% Un (4)
Output rated current	>25 A for 400 ms (4)	>25 A for 400 ms (4)	>25 A for 400 ms (4)	>25 A for 400 ms (4)
Output rated current	< 1%	< 1%	< 1%	< 1%
Output voltage regulation	≤ 50 mVpp	≤ 50 mVpp	≤ 50 mVpp	≤ 50 mVpp
Output voltage ripple	>30 ms / >60 ms	>30 ms / >60 ms	>30 ms / >60 ms	>30 ms / >60 ms
Output voltage ripple	hiccup at the overload limit with auto reset / over temperature protection			
Output voltage ripple	"DC OK" green LED / "DC OK" alarm contact/ "Overload" red LED			
Output voltage ripple	21.6 Vdc	10.8 Vdc	10.8 Vdc	43.2 Vdc
Output voltage ripple	possible	possible	possible	possible
Output voltage ripple	possible with external ORing diode	factory provided with internal ORing diode	possible with external ORing diode	factory provided with internal ORing diode
GENERAL TECHNICAL DATA	>88% / >90%	>85% / >85%	>85% / >85%	>89% / >89%
Efficiency (Uin 120 / 230 Vac)	32 W / 27 W	42 W / 42 W	42 W / 42 W	28 W / 28 W
Dissipated power (Uin 120 / 230 Vac)	-20...+60°C, with derating over 45°C / over temperature protection (3)			
Operating temperature range	3 kVac / 60 s SELV output			
Input/output isolation	1.5 kVac / 60 s			
Input/ground isolation	0.5 kVac / 60 s			
Output/ground isolation	EN50178, EN61558, EN60950, IEC950, UL508, UL60950			
Standard/approvals	EN61000-6-2, EN61000-6-4, EN61000-4-2, EN61000-4-3, EN61000-4-3, EN61000-4-4, EN61000-4-5, EN61000-4-6, EN61000-4-11			
EMC Standards	>500'000 h acc. to SN 29500 / >150'000 h acc. to MIL Std. HDBK 217F			
MTBF @ 25°C @ nominal ratings	II / 3			
Overvoltage category/Pollution degree	IP 20 IEC 529, EN60529			
Protection degree	2.5 mm² pluggable screw type			
Connection terminal	aluminium			
Housing material	920 g (32.48 oz)			
Approx. weight	vertical on rail, allow 10 mm spacing between adjacent components			
Mounting information	PR/3/AC, PR/3/AC/ZB, PR/3/AS, PR/3/AS/ZB			
MOUNTING ACCESSORIES	—			
Mounting rail type according to IEC60715/TH35-7.5				
Mounting rail type according to IEC60715/G32				

# Single-phase switching power supply 120-230 Vac output power 240 W

- Single-phase input 120 and 230 Vac
- Short circuit, overload, over temperature, input and output overvoltage protections
- High outrush current to guarantee downstream overcurrent protections selectivity and to start-up heavy loads
- Failure contact for Uout -10%
- Compact dimensions
- Suitable for applications in PELV circuits

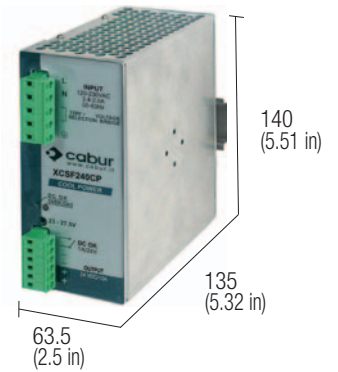

## NOTES

- The depth dimension includes the terminal blocks and the DIN clamp.
- (2) Double input selectable with external jumper, DC supply allow only between 300 and 345 Vdc
  - (3) Over 45°C (113°F) apply a derating: -0.17 A/°C for version C, CP and CPH; -0.27 A/°C for version B; -0.08 A/°C for version DP;
  - (4) For this peak current, the output voltage does not drop more than 10% of the nominal value, but the current value, provided by the power supply also depends on the total line resistance.
  - (5) Version CSF240G is not suitable for SELV applications

## VERSIONS

Output 72 Vdc 3.5 A redundant version

## BLOCK DIAGRAM

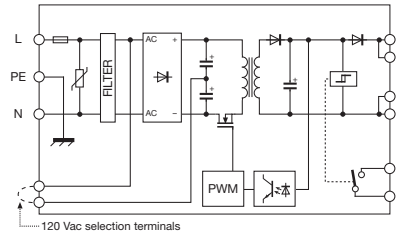

Special version for DC motors

Cod. XCSF240G

CSF240G

## INPUT TECHNICAL DATA

Input rated voltage	120 - 230 Vac (range 90...132 Vac / 185...264 Vac / 300...345 Vdc) (2)
Frequency	47...63 Hz
Current @ nominal Iout (Uin 120 / 230 Vac)	3.5 A / 1.8 A ± 10%
Inrush peak current	< 35 A
Power factor	> 0.6
Internal protection fuse	T 6.3 A replaceable
External protection on AC line	circuit breaker: 10 A - C characteristic - fuse: T 10 A

Input rated voltage	120 - 230 Vac (range 90...132 Vac / 185...264 Vac / 300...345 Vdc) (2)
Frequency	47...63 Hz
Current @ nominal Iout (Uin 120 / 230 Vac)	3.5 A / 1.8 A ± 10%
Inrush peak current	< 35 A
Power factor	> 0.6
Internal protection fuse	T 6.3 A replaceable
External protection on AC line	circuit breaker: 10 A - C characteristic - fuse: T 10 A

## OUTPUT TECHNICAL DATA

Output rated voltage	72 Vdc
Output adjustable range	72...85 Vdc
Continuous current	3.5 A @ 50°C (3)
Overload limit	>13.8A for >30 s with Uout >90% Un (4)
Short circuit peak current	>25 A for 400 ms (4)
Load regulation	< 1%
Ripple @ nominal ratings	≤ 50 mVpp
Hold up time @ In (Uin 120 / 230 Vac)	>30 ms / >60 ms
Overload / short circuit protections	hiccup at the overload limit with auto reset / over temperature protection
Status display	"DC OK" green LED / "DC OK" alarm contact/ "Overload" red LED
Alarm contact threshold	64.8 Vdc
Parallel connection	possible
Redundant parallel connection	factory provided with internal ORing diode

Output rated voltage	72 Vdc
Output adjustable range	72...85 Vdc
Continuous current	3.5 A @ 50°C (3)
Overload limit	>13.8A for >30 s with Uout >90% Un (4)
Short circuit peak current	>25 A for 400 ms (4)
Load regulation	< 1%
Ripple @ nominal ratings	≤ 50 mVpp
Hold up time @ In (Uin 120 / 230 Vac)	>30 ms / >60 ms
Overload / short circuit protections	hiccup at the overload limit with auto reset / over temperature protection
Status display	"DC OK" green LED / "DC OK" alarm contact/ "Overload" red LED
Alarm contact threshold	64.8 Vdc
Parallel connection	possible
Redundant parallel connection	factory provided with internal ORing diode

## GENERAL TECHNICAL DATA

Efficiency (Uin 120 / 230 Vac)	>89.5% / >89.5%
Dissipated power (Uin 120 / 230 Vac)	28 W / 28 W
Operating temperature range	-20...+60°C, with derating over 45°C / over temperature protection (3)
Input/output isolation	3 kVac / 60 s not SELV output (5)
Input/ground isolation	1.5 kVac / 60 s
Output/ground isolation	0.5 kVac / 60 s
Standard/approvals	IEC950, EN60950, UL508
EMC Standards	EN61000-6-2, EN61000-6-4, EN61000-4-2, EN61000-4-3, EN61000-4-4, EN61000-4-5, EN61000-4-6, EN61000-4-11
MTBF @ 25°C @ nominal ratings	>500'000 h acc. to SN 29500 / >150'000 h acc. to MIL Std. HDBK 217F
Overvoltage category/Pollution degree	II / 3
Protection degree	IP 20 IEC 529, EN60529
Connection terminal	2.5 mm² pluggable screw type
Housing material	aluminium
Approx. weight	920 g (32.48 oz)
Mounting information	vertical on rail, allow 10 mm spacing between adjacent components

Efficiency (Uin 120 / 230 Vac)	>89.5% / >89.5%
Dissipated power (Uin 120 / 230 Vac)	28 W / 28 W
Operating temperature range	-20...+60°C, with derating over 45°C / over temperature protection (3)
Input/output isolation	3 kVac / 60 s not SELV output (5)
Input/ground isolation	1.5 kVac / 60 s
Output/ground isolation	0.5 kVac / 60 s
Standard/approvals	IEC950, EN60950, UL508
EMC Standards	EN61000-6-2, EN61000-6-4, EN61000-4-2, EN61000-4-3, EN61000-4-4, EN61000-4-5, EN61000-4-6, EN61000-4-11
MTBF @ 25°C @ nominal ratings	>500'000 h acc. to SN 29500 / >150'000 h acc. to MIL Std. HDBK 217F
Overvoltage category/Pollution degree	II / 3
Protection degree	IP 20 IEC 529, EN60529
Connection terminal	2.5 mm² pluggable screw type
Housing material	aluminium
Approx. weight	920 g (32.48 oz)
Mounting information	vertical on rail, allow 10 mm spacing between adjacent components

## MOUNTING ACCESSORIES

Mounting rail type according to IEC60715/TH35-7.5  
Mounting rail type according to IEC60715/G32

PR/3/AC, PR/3/AC/ZB, PR/3/AS, PR/3/AS/ZB

# Single-phase switching power supply 120-230 Vac output power 500 W

- Single-phase input 120 and 230 Vac
- Short circuit, overload, over temperature, input and output overvoltage protections
- High outrush current to guarantee downstream overcurrent protections selectivity and to start-up heavy loads
- Compact dimensions
- Suitable for applications in SELV and PELV circuits
- Failure contact for Uout -10%

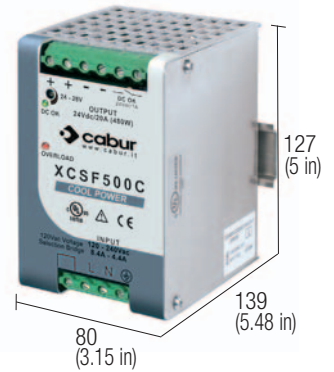

## NOTES

- The depth dimension includes the DIN rail clamp.
- (2) Double input selectable with external jumper.
  - (3) Over 45°C (113°F) apply a derating: C version: -0.34 A/°C for version C; -0.17 A/°C for version D;
  - (4) For this peak current, the output voltage does not drop more than 10% of the nominal value, but the current value, provided by the power supply also depends on the total line resistance.

## BLOCK DIAGRAM

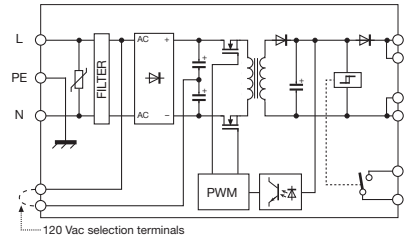

Special version for DC motors

VERSIONS	Cod. XCSF500C		Cod. XCSF500D
Output 24 Vdc 20 A	-		
Output 24 Vdc 20 A redundant version			
Output 12...15 Vdc 40 A			
Output 48 Vdc 10 A redundant version			
<b>INPUT TECHNICAL DATA</b>	<b>CSF500C</b>		
Input rated voltage	120-230 Vac (range 90...132 Vac / 185...264 Vac) (2)		
Frequency	47...63 Hz		
Current @ nominal Iout (Iin 120 / 230 Vac)	4.1 A / 2 A ± 10%		
Inrush peak current	< 25 A with electronic limiter		
Power factor	> 0.75 with PFC		
Internal protection fuse	-		
External protection on AC line	circuit breaker: 16 A C characteristic - fuse: T 15 A		
<b>OUTPUT TECHNICAL DATA</b>	<b>24 Vdc</b>		<b>48 Vdc</b>
Output rated voltage	24...28 Vdc		45...55 Vdc
Output adjustable range			
Continuous current	<b>20 A @ 45°C (3)</b>		<b>10 A @ 45°C (3)</b>
Overload limit	30 A for >5 s with Uout >90% Un (4)		15 A for >5 s with Uout >90% Un (4)
Short circuit peak current	>50 A for 5 s (4)		>50 A for 5 s (4)
Load regulation	< 0.5%		< 0.5%
Ripple @ nominal ratings	≤ 50 mVpp		≤ 50 mVpp
Hold up time @ In (Iin 120 / 230 Vac)	>12 ms / >20 ms		>12 ms / >20 ms
Overload / short circuit protections	hiccup at the overload limit with auto reset / over temperature protection		
Status display	"DC OK" green LED / "DC OK" alarm contact/ "Overload" red LED		
Alarm contact threshold	21.6 Vdc		43.2 Vdc
Parallel connection	possible		possible
Redundant parallel connection	factory provided with internal ORing diode		factory provided with internal ORing diode
<b>GENERAL TECHNICAL DATA</b>			
Efficiency (Iin 120 / 230 Vac)	>92% / >92%		>92% / >92%
Dissipated power (Iin 120 / 230 Vac)	42 W / 42 W		42 W / 42 W
Operating temperature range	-20...+60°C, with derating over 45°C / over temperature protection (3)		
Input/output isolation	3 kVac / 60 s SELV output		
Input/ground isolation	1.5 kVac / 60 s		
Output/ground isolation	0.5 kVac / 60 s		
Standard/approvals	EN50178, EN61558, EN60950, IEC950, UL508		
EMC Standards	EN61000-6-2, EN61000-6-4, EN61000-4-2, EN61000-4-3, EN61000-4-4, EN61000-4-5, EN61000-4-6, EN61000-4-11		
MTBF @ 25°C @ nominal ratings	>500'000 h acc. to SN 29500 / >150'000 h acc. to MIL Std. HDBK 217F		
Overvoltage category/Pollution degree	II / 2		
Protection degree	IP 20 IEC 529, EN60529		
Connection terminal	4 and 6 mm² fixed screw type		
Housing material	aluminium		
Approx. weight	1,3 kg (45.89 oz)		
Mounting information	vertical on rail, allow 10 mm spacing between adjacent components		
<b>MOUNTING ACCESSORIES</b>			
Mounting rail type according to IEC60715/TH35-7.5	PR/3/AC, PR/3/AC/ZB, PR/3/AS, PR/3/AS/ZB		
Mounting rail type according to IEC60715/G32	-		

# Single-phase switching power supply 120-230 Vac output power 500 W

- Single-phase input 120 and 230 Vac
- Short circuit, overload, over temperature, input and output overvoltage protections
- High outrush current to guarantee downstream overcurrent protections selectivity and to start-up heavy loads
- Compact dimensions
- Suitable for applications in PELV circuits

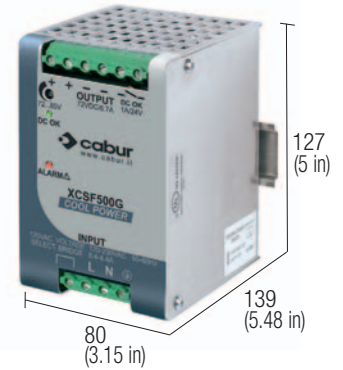

## NOTES

- The depth dimension includes the DIN rail clamp.
- (2) Double input selectable with external jumper.
  - (3) Over 45°C (113°F) apply a derating: C version: -0.34 A/°C for version C; -0.17 A/°C for version D;
  - (4) For this peak current, the output voltage does not drop more than 10% of the nominal value, but the current value, provided by the power supply also depends on the total line resistance.
  - (5) Version CSF240G is not suitable for SELV applications

## BLOCK DIAGRAM

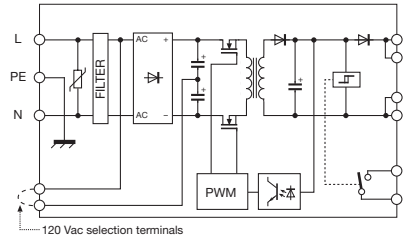

### Special version for DC motors

Cod. XCSF500G

CSF500G

## VERSIONS

Sortie 72 Vdc 6.7 A redundant version

## INPUT TECHNICAL DATA

Input rated voltage	<b>120-230 Vac</b> (échelle 90...132 Vac / 185...264 Vac) (2)
Frequency	47...63 Hz
Current @ nominal lout (Uin 120 /230 Vac)	8.4 A / 4.4 A ± 10%
Inrush peak current	< 35 A
Power factor	> 0.67
Internal protection fuse	—
External protection on AC line	circuit breaker: 16 A C characteristic - fuse: T 15 A

## OUTPUT TECHNICAL DATA

Output rated voltage	<b>72 Vdc</b>
Output adjustable range	72...85 Vdc
Continuous current	<b>6.7 A @ 50°C (3)</b>
Overload limit	>10A for >5 s with Uout >90% Un (4)
Short circuit peak current	>20 A for 400 ms (4)
Load regulation	< 1%
Ripple @ nominal ratings	≤ 100 mVpp
Hold up time @ In (Uin 120 / 230 Vac)	>30 ms / >35ms
Overload / short circuit protections	hiccup at the overload limit with auto reset / over temperature protection
Status display	"DC OK" green LED / "DC OK" alarm contact/ "Overload" red LED
Alarm contact threshold	<64.8 Vd
Parallel connection	possible
Redundant parallel connection	factory provided with internal ORing diode

## GENERAL TECHNICAL DATA

Efficiency (Uin 120 / 230 Vac)	>92% / >92%
Dissipated power (Uin 120 / 230 Vac)	42 W / 42 W
Operating temperature range	-20...+60°C, with derating over 45°C / over temperature protection (3)
Input/output isolation	3 kVac / 60 s SELV output (5)
Input/ground isolation	2 kVac / 60 s
Output/ground isolation	0.7 kVac / 60 s
Standard/approvals	IEC950, EN60950, UL508
EMC Standards	EN61000-6-2, EN61000-6-4, EN61000-4-2, EN61000-4-3, EN61000-4-4, EN61000-4-5, EN61000-4-6, EN61000-4-11
MTBF @ 25°C @ nominal ratings	>500'000 h acc. to SN 29500 / >150'000 h acc. to MIL Std. HDBK 217F
Overvoltage category/Pollution degree	
Protection degree	IP 20 IEC 529, EN60529
Connection terminal	4 and 6 mm² fixed screw type
Housing material	aluminium
Approx. weight	1,3 kg (45.89 oz)
Mounting information	vertical on rail, allow 10 mm spacing between adjacent components

## MOUNTING ACCESSORIES

Mounting rail type according to IEC60715/TH35-7.5	<b>PR/3/AC, PR/3/AC/ZB, PR/3/AS, PR/3/AS/ZB</b>
Mounting rail type according to IEC60715/G32	—



# Single-phase switching power supply 120-230 Vac IP65 protection degree

- Single-phase input 90...264 Vac and DC 100...345 Vdc
- Short circuit, overload, over temperature, input and output overvoltage protections
- Suitable to be mounted directly on the machinery frame, don't require any protective enclosure
- IP65 pluggable screw connectors
- Suitable for applications in SELV and PELV circuits

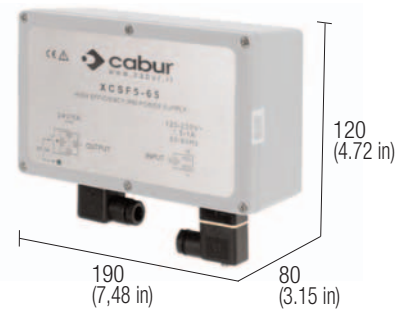

## NOTES

The depth dimension includes the terminal blocks and the DIN clamp.

- (1) With 100...127 Vdc input voltage, constant output power and  $T_a > 45^\circ\text{C}$ , the output current must be derated by 25%
- (2) Overload and short circuit current depends on the total line resistance.
- (3) Version available upon request; for information call our sales department, local agent or representative

## BLOCK DIAGRAM

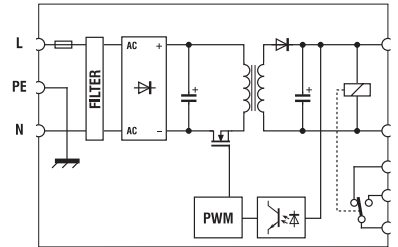

## VERSIONS

Output 24 Vdc 5 A

Cod. XCSF565

CSF5-65 (3)

## INPUT TECHNICAL DATA

Input rated voltage	<b>120-230 Vac</b> (range 90...264 Vac / 100...345 Vdc) (1)
Frequency	47...63 Hz
Current @ nominal lout (Uin 120 / 230 Vac)	1.8 A / 1 A $\pm 10\%$
Inrush peak current	< 20 A
Power factor	> 0.7
Internal protection fuse	T 3.15 A replaceable
External protection on AC line	circuit breaker: 4 A - C characteristic - fuse: T 4 A

## OUTPUT TECHNICAL DATA

Output rated voltage	<b>24 Vdc</b>
Output adjustable range	23...27.5 Vdc
Continuous current	<b>5 A @ 60°C</b>
Overload limit	8 A (2)
Short circuit peak current	—
Load regulation	< 1%
Ripple @ nominal ratings	$\leq 50$ mVpp
Hold up time @ In (Uin 120 / 230 Vac)	>10 ms / >20 ms
Overload / short circuit protections	hiccup at the overload limit with auto reset / over temperature protection
Status display	"DC OK" green LED / "DC OK" alarm contact
Alarm contact threshold	—
Parallel connection	possible
Redundant parallel connection	possible with external ORing diode

## GENERAL TECHNICAL DATA

Efficiency (Uin 120 / 230 Vac)	>86% / >90%
Dissipated power (Uin 120 / 230 Vac)	18,6 W / 12,6 W
Operating temperature range	-20...+60°C / over temperature protection
Input/output isolation	3 kVac / 60 s SELV output
Input/ground isolation	1.5 kVac / 60 s
Output/ground isolation	0.5 kVac / 60 s
Standard/approvals	EN50178, EN61558, EN60950, IEC950, UL508
EMC Standards	EN61000-6-2, EN61000-6-4, EN61000-4-2, EN61000-4-3, EN61000-4-4, EN61000-4-5, EN61000-4-6, EN61000-4-11
MTBF @ 25°C @ nominal ratings	>500'000 h acc. to SN 29500 / >150'000 h acc. to MIL Std. HDBK 217F
Overvoltage category/Pollution degree	II / 2
Protection degree	IP 20 IEC 529, EN60529
Connection terminal	2.5 mm <sup>2</sup> IP65 pluggable screw connectors
Housing material	aluminium
Approx. weight	1.9 kg (67.02 oz)
Mounting information	vertical on rail or panel mounting by means of screws

## MOUNTING ACCESSORIES

Mounting rail type according to IEC60715/TH35-7.5	<b>PR/3/AC, PR/3/AC/ZB, PR/3/AS, PR/3/AS/ZB</b>
Mounting rail type according to IEC60715/G32	—

# Switching power supply CSL series

## EASY POWER

**Single phase DIN rail power supplies** for general applications in automation and installation. **With particularly high quality / price ratio**, these products are ideal and convenient for applications where loads do not require high peak currents. They can deliver over +50% of nominal current for a sustained period, keeping the output voltage stable and ensuring continuity of supply to the system. **With these features, this range of power supplies enables designers to meet the requirements of the Machinery Directive, EN 60204-1**, allowing the protection devices connected to the output to trigger quickly, safely and selectively, thus ensuring continuity of service to the other parts of the system.

### Suggested uses

- Applications in civil automation
- General applications in the installation of systems

### Main features

- Equipped with 120 - 230 Vac input, they are suitable for use in all single-phase networks.
- Their high efficiency reduces energy consumption and components' operating temperature allowing their use in small panels and under severe ambient conditions.
- Backup power +50% above the rated voltage ensuring safety and reliability.
- The output voltage may be adjusted and is protected against the input of surges caused by inductive loads on the DC line and is equipped with double electronic protection devices preventing damages to powered equipment in the event of internal faults.
- Short-circuit, overload and thermal protection devices prevent faults in the event of prolonged overloads at high ambient temperatures.
- Their design ensures excellent ventilation to internal components, very small dimensions and IP20 protection against accidental contacts in compliance with IEC529.
- Compared to other products having similar power and costs, they offer higher performances, functions and reliability.



### Short circuit, overload and thermal protections

Avoids failures caused by overload at high ambient temperatures

### Adjustable output voltage

Protected against the input of surges coming from the DC line and caused by inductive loads

### Power boost

The output power reaches 120% of the nominal value for several minutes, up to 150% during an overload, and up to 300% in the event of a short-circuit, to enable the protection devices connected to the output to trigger quickly, safely and selectively, without the use of additional modules!

### Extremely compact dimensions

They are among the smallest on the market, optimising the use of space in the panel without compromising performance



### High Performance

Reduces energy consumption and reduces the working temperature of the components and allows use in small panel and in heavy environmental conditions

# Single-phase switching power supply 120-230 Vac output power 85 W

- Single-phase input 90...264 Vac
- Short circuit, overload, over temperature, input and output overvoltage protections
- Suitable in civil automation and general applications in the installation of systems
- Suitable for applications in SELV and PELV circuits

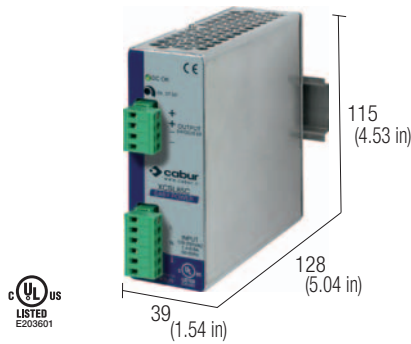

## NOTES

The depth dimension includes the terminal blocks and the DIN clamp.

(3) Over 45°C (113°F) apply a derating of -0.06 A/°C

(4) For this peak current, the output voltage does not drop more than 10% of the nominal value, but the current value, provided by the power supply also depends on the total line resistance.

## BLOCK DIAGRAM

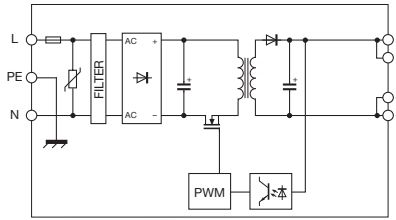

## VERSIONS

Output 24 Vdc 5 A  
Output 24 Vdc 5

Cod. XCSL85C

CSL85C

## INPUT TECHNICAL DATA

Input rated voltage  
Frequency  
Current @ nominal lout (Uin 120 /230 Vac)  
Inrush peak current  
Power factor  
Internal protection fuse  
External protection on AC line

**120-230 Vac** (range 90...264 Vac)

47...63 Hz

1.6A / 0.9 A ± 10%

< 20 A

> 0.65

T 2 A replaceable

circuit breaker: 4 A - C characteristic - fuse: T 4 A

## OUTPUT TECHNICAL DATA

Output rated voltage  
Output adjustable range  
Continuous current  
Overload limit  
Short circuit peak current  
Load regulation  
Ripple @ nominal ratings  
Hold up time @ In (Uin 120 / 230 Vac)  
Overload / short circuit protections

**24 Vdc**

23...27.5 Vdc

**3.5 A @ 45°C (3)**

5,5 A for >30 s with Uout >90% Un (4)

9 A for 50 ms

< 1%

70 mVpp

>20 ms / >70 ms

hiccup at the overload limit with auto reset / over temperature

protection

"DC OK" green LED

—

possible

possible with external ORing diode

## GENERAL TECHNICAL DATA

Efficiency (Uin 120 / 230 Vac)  
Dissipated power (Uin 120 / 230 Vac)  
Operating temperature range  
Input/output isolation  
Input/ground isolation  
Output/ground isolation  
Standard/approvals  
EMC Standards

>86% / >90%

14 W / 10 W

-20...+60°C, with derating over 45°C / over temperature protection (3)

3 kVac / 60 s SELV output

1.5 kVac / 60 s

0.5 kVac / 60 s

EN50178, EN61558, EN60950, IEC950, UL508

EN61000-6-2, EN61000-6-4, EN61000-4-2, EN61000-4-3,

EN61000-4-4, EN61000-4-5, EN61000-4-6, EN61000-4-11

>400'000 h acc. to SN 29500 / >100'000 h acc. to MIL Std.

HDBK 217F

II / 2

IP 20 IEC 529, EN60529

2.5 mm<sup>2</sup> pluggable screw type

aluminium and stainless steel

400 g (14.10 oz)

vertical on rail, allow 10 mm spacing between adjacent components

## MOUNTING ACCESSORIES

Mounting rail type according to IEC60715/TH35-7.5  
Mounting rail type according to IEC60715/G32

PR/3/AC, PR/3/AC/ZB, PR/3/AS, PR/3/AS/ZB

—

# Single-phase switching power supply 120-230 Vac output power 120 W

- Single-phase input 90...264 Vac
- Short circuit, overload, over temperature, input and output overvoltage protections
- Suitable in civil automation and general applications in the installation of systems
- Suitable for applications in SELV and PELV circuits

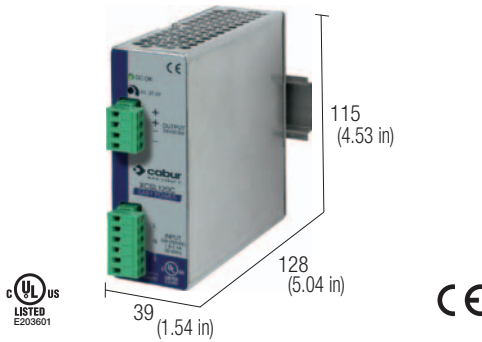

## NOTES

The depth dimension includes the terminal blocks and the DIN clamp.

(3) Over 45°C (113°F) apply a derating of -0.08 A/°C

(4) For this peak current, the output voltage does not drop more than 10% of the nominal value, but the current value, provided by the power supply also depends on the total line resistance.

## BLOCK DIAGRAM

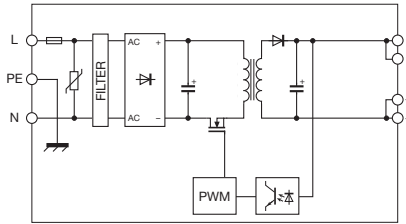

## VERSIONS

- Output 24 Vdc 5 A
- Output 24 Vdc 5 A

## Cod. XCSL120C

CSL120C

## INPUT TECHNICAL DATA

- Input rated voltage
- Frequency
- Current @ nominal lout (Uin 120 /230 Vac)
- Inrush peak current
- Power factor
- Internal protection fuse
- External protection on AC line

## 120-230 Vac (range 90...264 Vac)

- 47...63 Hz
- 1.9 A / 1.1 A ± 10%
- < 20 A
- > 0.65
- T 3.15 A replaceable
- circuit breaker: 4 A - C characteristic - fuse: T 4 A

## OUTPUT TECHNICAL DATA

- Output rated voltage
- Output adjustable range
- Continuous current
- Overload limit
- Short circuit peak current
- Load regulation
- Ripple @ nominal ratings
- Hold up time @ In (Uin 120 / 230 Vac)
- Overload / short circuit protections

## 24 Vdc

- 23...27.5 Vdc
- 5 A @ 45°C (3)
- 8 A for >30 s with Uout > 90% Un (4)
- 13 A for 50 ms (4)
- < 1%
- 30 mVpp
- >17 ms / >72 ms
- hiccup at the overload limit with auto reset / over temperature protection

## GENERAL TECHNICAL DATA

- Status display
- Alarm contact threshold
- Parallel connection
- Redundant parallel connection
- Efficiency (Uin 120 / 230 Vac)
- Dissipated power (Uin 120 / 230 Vac)
- Operating temperature range
- Input/output isolation
- Input/ground isolation
- Output/ground isolation
- Standard/approvals
- EMC Standards
- MTBF @ 25°C @ nominal ratings
- Overvoltage category/Pollution degree
- Protection degree
- Connection terminal
- Housing material
- Approx. weight
- Mounting information

## "DC OK" green LED

- possible
- possible with external ORing diode
- >86% / >90%
- 19 W / 13 W
- 20...+60°C, with derating over 45°C / over temperature protection (3)
- 3 kVac / 60 s SELV output
- 1.5 kVac / 60 s
- 0.5 kVac / 60 s
- EN50178, EN61558, EN60950, IEC950, UL508
- EN61000-6-2, EN61000-6-4, EN61000-4-2, EN61000-4-3, EN61000-4-4, EN61000-4-5, EN61000-4-6, EN61000-4-11
- >400'000 h acc. to SN 29500 / >100'000 h acc. to MIL Std. HDBK 217F
- II / 2
- IP 20 IEC 529, EN60529
- 2.5 mm<sup>2</sup> pluggable screw type
- aluminium and stainless steel
- 400 g (14.10 oz)
- vertical on rail, allow 10 mm spacing between adjacent components

## MOUNTING ACCESSORIES

- Mounting rail type according to IEC60715/TH35-7.5
- Mounting rail type according to IEC60715/G32

## PR/3/AC, PR/3/AC/ZB, PR/3/AS, PR/3/AS/ZB

-

# Single-phase switching power supply 120-230 Vac output power 240 W

- Single-phase input 120 and 230 Vac
- Short circuit, overload, over temperature, input and output overvoltage protections
- Suitable in civil automation and general applications in the installation of systems
- Suitable for applications in SELV and PELV circuits

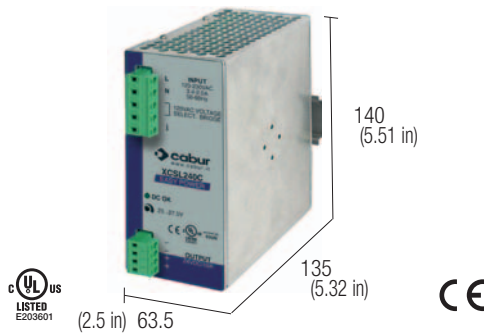

## NOTES

The depth dimension includes the terminal blocks and the DIN clamp.

(2) Double input selectable with external jumper.

(3) Over 45°C (113°F) apply a derating of -0.17 A/°C

(4) For this peak current, the output voltage does not drop more than 10% of the nominal value, but the current value, provided by the power supply also depends on the total line resistance.

(5) Version available after September 2011

## BLOCK DIAGRAM

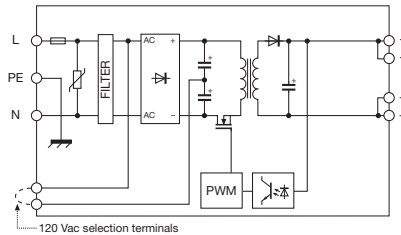

## VERSIONS

Output 24 Vdc 10 A

Cod. XCSL240C

CSL240C (5)

## INPUT TECHNICAL DATA

Input rated voltage

Frequency

Current @ nominal lout (Uin 120 / 230 Vac)

Inrush peak current

Power factor

Internal protection fuse

External protection on AC line

**120-230 Vac** (range 90...132 Vac / 185...264 Vac) (2)

47...63 Hz

3.5A / 1.8 A ± 10%

< 35 A

> 0.6 / >0.85

T 6.3 A replaceable

circuit breaker: 10 A - C characteristic - fuse: T 10 A

## OUTPUT TECHNICAL DATA

Output rated voltage

Output adjustable range

Continuous current

Overload limit

Short circuit peak current

Load regulation

Ripple @ nominal ratings

Hold up time @ In (Uin 120 / 230 Vac)

Overload / short circuit protections

**24 Vdc**

23...27.5 Vdc

**10 A @ 45°C** (3)

15 A for >30 s with Uout > 90% Un (4)

>25 A for 400 ms

< 1%

50 mVpp

>30 ms / >60 ms

hiccup at the overload limit with auto reset / over temperature protection

"DC OK" green LED

—

possible

possible with external ORing diode

## GENERAL TECHNICAL DATA

Efficiency (Uin 120 / 230 Vac)

Dissipated power (Uin 120 / 230 Vac)

Operating temperature range

Input/output isolation

Input/ground isolation

Output/ground isolation

Standard/approvals

EMC Standards

MTBF @ 25°C @ nominal ratings

>88% / >90%

32 W / 27 W

-20...+60°C, with derating over 45°C / over temperature protection (3)

3 kVac / 60 s SELV output

1.5 kVac / 60 s

0.5 kVac / 60 s

EN50178, EN61558, EN60950, IEC950, UL508

EN61000-6-2, EN61000-6-4, EN61000-4-2, EN61000-4-3, EN61000-4-4, EN61000-4-5, EN61000-4-6, EN61000-4-11 >400'000 h acc. to SN 29500 / >100'000 h acc. to MIL Std.

HDBK 217F

II / 2

IP 20 IEC 529, EN60529

2.5 mm<sup>2</sup> pluggable screw type

aluminium and stainless steel

920 g (32.48 oz)

vertical on rail, allow 10 mm spacing between adjacent components

## MOUNTING ACCESSORIES

Mounting rail type according to IEC60715/TH35-7.5

Mounting rail type according to IEC60715/G32

**PR/3/AC, PR/3/AC/ZB, PR/3/AS, PR/3/AS/ZB**

—



# output power 480 W Single-phase switching power supply 230 Vac

- Single-phase input 230 Vac
- Short circuit, overload, over temperature, input and output overvoltage protections
- Suitable in civil automation and general applications in the installation of systems
- Suitable for applications in SELV and PELV circuits

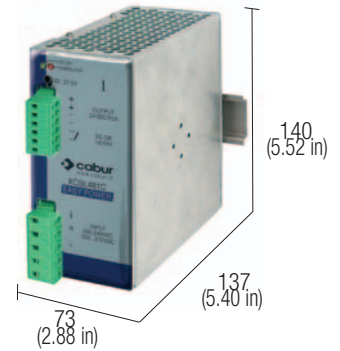

## NOTES

The depth dimension includes the terminal blocks and the DIN clamp.  
 (3) Over 45°C (113°F) apply a derating of about 16 W/°C  
 (4) For this peak current, the output voltage does not drop more than 10% of the nominal value, but the current value, provided by the power supply also depends on the total line resistance.

## BLOCK DIAGRAM

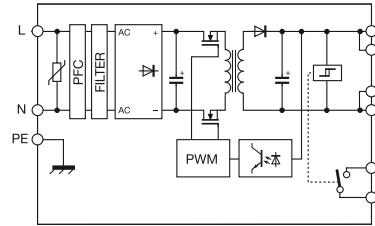

## VERSIONS

Output 24 Vdc 20 A

## Cod. XCSL481C

CSL481C (5)

## INPUT TECHNICAL DATA

Input rated voltage  
 Frequency  
 Current @ nominal lout (Uin 120 /230 Vac)  
 Inrush peak current  
 Power factor  
 Internal protection fuse  
 External protection on AC line

**230 Vac** (range 187...264 Vac) (2)  
 47...63 Hz  
 - / 2 A  
 <20 A  
 > 0,95  
 -  
 circuit breaker: 6 A - C characteristic - fuse: T 6,3 A

## OUTPUT TECHNICAL DATA

Output rated voltage  
 Output adjustable range  
 Continuous current  
 Overload limit  
 Short circuit peak current  
 Load regulation  
 Ripple @ nominal ratings  
 Hold up time @ In (Uin 120 / 230 Vac)  
 Overload / short circuit protections  
 Status display  
 Alarm contact threshold  
 Parallel connection  
 Redundant parallel connection

**24 Vdc**  
 23...27.5 Vdc  
**20 A @ 45°C** (3)  
 28 A (4)  
 50 A for 0,3 s  
 < 1%  
 ≤ 100 mVpp  
 - / >20 ms  
 hiccup at the overload limit with auto reset / over temperature protection  
 "DC OK" green LED  
 21,6 Vdc  
 possible  
 possible with external ORing diode

## GENERAL TECHNICAL DATA

Efficiency (Uin 120 / 230 Vac)  
 Dissipated power (Uin 120 / 230 Vac)  
 Operating temperature range  
 Input/output isolation  
 Input/ground isolation  
 Output/ground isolation  
 Standard/approvals  
 EMC Standards  
 MTBF @ 25°C @ nominal ratings  
 Overvoltage category/Pollution degree  
 Protection degree  
 Connection terminal  
 Housing material  
 Approx. weight  
 Mounting information

- / >92%  
 - / 42 W  
 -20...+60°C, with derating over 45°C / over temperature protection (3)  
 3 kVac / 60 s SELV output  
 2 kVac / 60 s  
 0.5 kVac / 60 s  
 EN50178, EN61558, EN60950, IEC950, UL508  
 EN61000-6-2, EN61000-6-4, EN61000-4-2, EN61000-4-3, EN61000-4-4, EN61000-4-5, EN61000-4-6, EN61000-4-11  
 >400'000 h acc. to SN 29500 / >100'000 h acc. to MIL Std. HDBK 217F  
 II / 2  
 IP 20 IEC 529, EN60529  
 2.5 mm<sup>2</sup> pluggable screw type  
 aluminium and stainless steel  
 1 kg (35.27 oz)  
 vertical on rail, allow 10 mm spacing between adjacent components

## MOUNTING ACCESSORIES

Mounting rail type according to IEC60715/TH35-7.5  
 Mounting rail type according to IEC60715/G32

**PR/3/AC, PR/3/AC/ZB, PR/3/AS, PR/3/AS/ZB**

# Switching power supply GSW series

## UNIVERSAL POWER

**DIN rail switching power supplies with universal input 185 ... 550 Vac single phase, 2-phase and 3-phase** applications in industrial automation and process control. The input circuit technology makes them immune to surges caused by failures in the 3-phase networks with neutral wire, increasing application reliability. Compared to single-phase power supplies, **this series has a higher reliability in industrial environments.** The input circuit uses components with an operating voltage of 900 V, more resistant to voltage peaks present in industrial networks, than the components used in single phase power supplies. The capability to operate from 185 to 550 Vac allows for installations in both single-phase 230V and 3-phase 400V networks.

### Suggested uses

- In single or 3-phase systems requiring great flexibility
- Applications in industrial automation and process control
- Heavy duty uses
- Applications in civil automation

### Main features

- The wide-range input 185...550 Vac may be supplied single-phase 230...240 Vac, 2-phase 208 Vac and 2-3-phase 400...500 Vac ensuring excellent adaptability to AC networks and enabling to get rid of the isolating transformer.
- The 2-phase and 3-phase input enables to reduce dimensions, wiring, installation costs and space inside the panel.
- They enable to get rid of the transformer for adapting to power voltages.
- Versions with DC OK alarm contact.
- Their high efficiency reduces energy consumption and components' operating temperature allowing their use in small panels and under severe ambient conditions.
- Great backup power allowing to supply at least + 50% above the rated voltage for 5 seconds ensuring safety and reliability.
- The output voltage may be adjusted and is protected against the input of surges on the DC line and is equipped with double electronic protection devices disconnecting output in the event of internal faults.
- Dimensioned short-circuit and overload protection supplying breakaway starting currents 150% above the rated value required by heavy loads; thermal protection prevents failures in the event of prolonged overloads at high ambient temperatures.
- Their design ensures excellent ventilation to internal components, very small dimensions and IP20 protection against accidental contacts in compliance with IEC529.
- Thanks to their high efficiency and excellent ventilation, they are the smallest devices available on the market.

### Greater reliability

Compared to single-phase power supplies, this Series is more reliable in industrial applications. The input stage uses components with 900 V operating voltage, which are more resistant to voltage peaks in industrial power lines compared to components used in single-phase supplies, whose operating voltage is 550V in high-quality power supplies, but often 400...450 V in low-cost products. Being able to work from 185 to 550 Vac, these power supplies are immune to power failures; at 230 Vac input (L1-N), when another device connected to L2-N goes short, the neutral rises up to approx. 400 Vac and the input is supplied phase/phase until the protection is activated, which takes place - at best - in 300 ms; this is one of the most common causes of damages to 230-Vac single-phase power supplies in industrial applications. Another example of faults in 230-Vac single-phase devices powered between phase-neutral is due to the disconnection or accidental interruption of the panel's neutral from the system's neutral: failing to return to the neutral point, the neutral rises up to phase voltage applying approx. 400 Vac to single-phase loads, inevitably damaging the system.

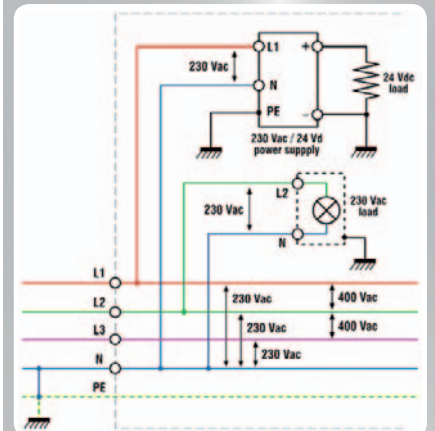

Typical application with 3-phase network and neutral. The latter is used to obtain a 230-Vac voltage in order to supply power to loads (in the example, a simple bulb) and power supplies.

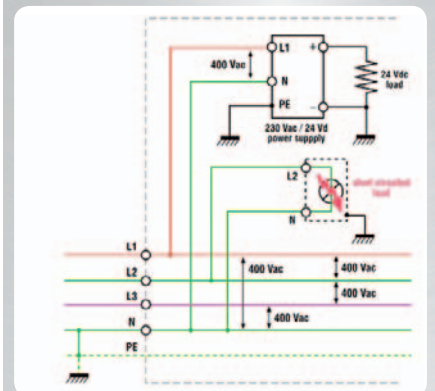

A simple short-circuit on the load causes a rise in the neutral's potential, all the devices connected to it will be powered between two phases, i.e. with a value of approx. 340...400 Vac instead of 230 Vac.

### 185...550 Vac wide range input

Connectable in 230 or 240V single-phase lines, in 208 2-phase lines, 400 or 500 V 2-3-phase lines for the maximum adaptability to the AC lines, by removing the isolation transformer

### Power boost

The output power reaches 120% of the nominal value for several minutes, up to 150% during an overload, and up to 250% in the event of a short-circuit, to enable the protection devices connected to the output to trigger quickly, safely and selectively, without the use of additional

### High Performance

Reduces energy consumption and the operating temperature of the components and allows installation in small panels

### 2-phase input

Saves space, wiring, installation costs

### Increased reliability in industrial environments

The input circuit uses components with a voltage of 900 V, more resistant to voltage peaks typical in industrial networks

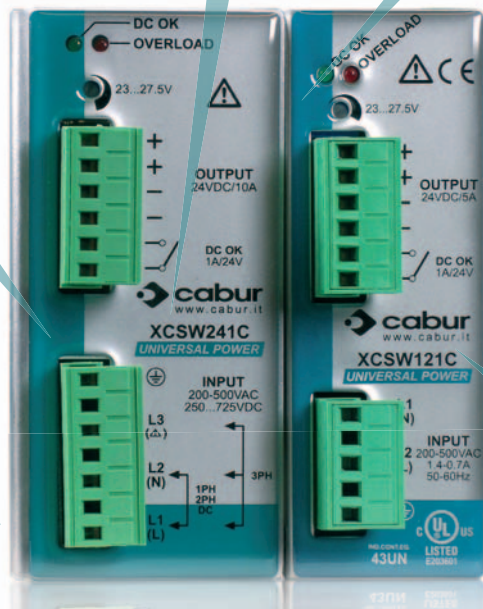

# 1 or 2-phase switching power supply 230-400-500 Vac output power 120 W

- Single-phase and 2-phase input 185...550 Vac
- High reliability and immunity against over voltage due to failures on AC line
- Short circuit, overload, over temperature, input and output overvoltage protections
- High outrush current to guarantee downstream overcurrent protections selectivity and to start-up heavy loads
- High efficiency and low dissipated power
- Suitable for applications in SELV and PELV circuits

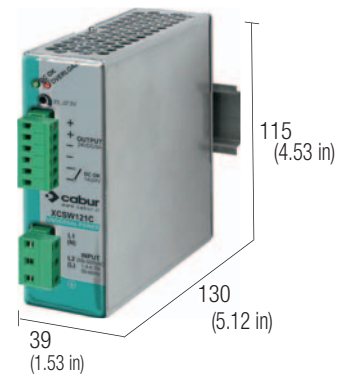

## NOTES

The depth dimension includes the terminal blocks and the DIN clamp.

- (1) Version available upon request; for information call our sales department, local agent or representative
- (2) 550 Vdc max for UL508
- (3) Over 50°C (122°F) apply a derating of about 3 W/°C
- (4) For this peak current, the output voltage does not drop more than 10% of the nominal value, but the current value, provided by the power supply also depends on the total line resistance.

## BLOCK DIAGRAM

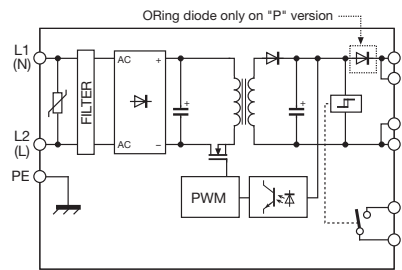

## VERSIONS

- Output 24 Vdc 5 A
- Output 12...15 Vdc 7 A
- Output 48 Vdc 2.5 A redundant version
- Output 72 Vdc 1.5 A redundant version

## INPUT TECHNICAL DATA

- Input rated voltage
- Frequency
- Current @ Iout max. (Uin 230 / 400 Vac)
- Inrush peak current
- Power factor
- Internal protection fuse
- External protection on AC line

1-2x 230-400-500 Vac (range 187...550 Vac / 270...725 Vdc) (2)

47...63 Hz

1.1 A / 0.55 A

< 20 A

> 0.65

—  
circuit breaker: 2x 6 A C characteristic - fuse: 2x T 4 A

## OUTPUT TECHNICAL DATA

- Output rated voltage
- Output adjustable range
- Continuous current
- Overload limit
- Short circuit peak current
- Load regulation
- Ripple @ nominal ratings
- Hold up time (Uin 230 / 400 Vac)
- Overload / short circuit protections
- Status display
- Alarm contact threshold
- Parallel connection
- Redundant parallel connection

**24 Vdc** 24...27.5 Vdc

**12...15 Vdc** 12...15 Vdc

**48 Vdc** 45...55 Vdc

**5 A** (3)

**8 A @ 12 Vdc / 7 A @ 15 Vdc**

**2.5 A** (3)

7.5 A for >30 s  
with Uout >90% Un

10 A for >30 s  
with Uout >90% Un

3.75 A for >30 s  
with Uout >90% Un (4)

14 A for 0.4 s (4)

20 A for 0.4 s (4)

14 A for 0.5 s (4)

< 1%

< 1%

< 1%

≤ 100 mVpp

≤ 100 mVpp

≤ 100 mVpp

>20 ms / >80 ms

>20 ms / >80 ms

>20 ms / >80 ms

hiccup at the overload limit with auto reset / over temperature protection

"DC OK" green LED / "DC OK" alarm contact/ "Overload" red LED

21.6 Vdc

10.8 Vdc

68 Vdc

possible

possible

possible

possible with external ORing diode

possible with external ORing diode

prepared with diode internal ORing

## GENERAL TECHNICAL DATA

- Efficiency (Uin 230 / 400 Vac)
- Dissipated power (Uin 230 / 400 Vac)
- Operating temperature range
- Input/output isolation
- Input/ground isolation
- Output/ground isolation
- Standard/approvals
- EMC Standards
- MTBF @ 25°C @ nominal ratings
- Overvoltage category/Pollution degree
- Protection degree
- Connection terminal
- Housing material
- Approx. weight
- Mounting information

>86% / >88%

>84% / >86%

>86% / >86%

20 W / 16 W

20 W / 17 W

20 W / 20 W

-20...+60°C, with derating over 50°C / over temperature protection (3)

3 kVac / 60 s SELV output

2 kVac / 60 s

0.5 kVac / 60 s

EN50178, EN61558, EN60950, IEC950, UL508

EN61000-6-2, EN61000-6-4, EN61000-4-2, EN61000-4-3, EN61000-4-4, EN61000-4-5, EN61000-4-6, EN61000-4-11

>500'000 h acc. to SN 29500 / >150'000 h acc. to MIL Std. HDBK 217F

II / 2

IP 20 IEC 529, EN60529

2.5 mm<sup>2</sup> pluggable screw type

aluminium and stainless steel

600 g (21.18 oz)

vertical on rail, allow 10 mm spacing between adjacent components

## MOUNTING ACCESSORIES

- Mounting rail type according to IEC60715/TH35-7.5
- Mounting rail type according to IEC60715/G32

PR/3/AC, PR/3/AC/ZB, PR/3/AS, PR/3/AS/ZB



# 1, 2 or 3-phase switching power supply 230-400-500 Vac output power 240 W

- Single-phase, 2-phase and 3-phase input 185...550 Vac
- High reliability and immunity against over voltage due to failures on AC line
- Short circuit, overload, over temperature, input and output overvoltage protections
- High outrush current to guarantee downstream overcurrent protections selectivity and to start-up heavy loads
- High efficiency and low dissipated power
- Suitable for applications in SELV and PELV circuits

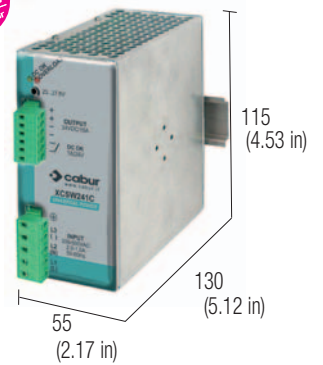

## NOTES

The depth dimension includes the terminal blocks and the DIN clamp.

- (1) Version available upon request; for information call our sales department, local agent or representative
- (2) 550 Vdc max for UL508
- (3) Over 50°C (122°F) apply a derating of about 3 W/°C
- (4) For this peak current, the output voltage does not drop more than 10% of the nominal value, but the current value, provided by the power supply also depends on the total line resistance.
- (5) Version CSW241G is not suitable for SELV applications

## BLOCK DIAGRAM

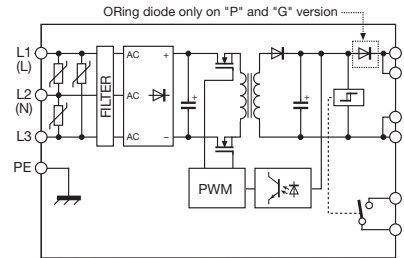

## VERSIONS

- Output 24 Vdc 10 A
- Output 12...15 Vdc 16...15 A
- Output 48 Vdc 5 A redundant version
- Output 72 Vdc 3.3 A redundant version

Cod. XCSW241C	Cod. XCSW241B	Cod. XCSW241DP	Cod. XCSW241G
CSW241C	CSW241B		
		CSW241DP (1)	
			CSW241G (1) (5)

## INPUT TECHNICAL DATA

Input rated voltage
Frequency
Current @ Iout max. (Uin 230 / 400 Vac)
Inrush peak current
Power factor
Internal protection fuse
External protection on AC line

1-2-3x 230-400-500 Vac (range 185...550 Vac / 270...770 Vdc) (2)
47...63 Hz
2 A / 1 A
< 20 A
> 0.65
-
circuit breaker: 2-3x 6 A C characteristic - fuse: 2-3x T 6.3 A

## OUTPUT TECHNICAL DATA

Output rated voltage
Output adjustable range
Continuous current
Overload limit
Short circuit peak current
Load regulation
Ripple @ nominal ratings
Hold up time (Uin 230 / 400 Vac)
Overload / short circuit protections
Status display
Alarm contact threshold
Parallel connection
Redundant parallel connection

24 Vdc	12...15 Vdc	48 Vdc	72 Vdc
24...27.5 Vdc	12...15 Vdc	45...55 Vdc	72...85 Vdc
10 A @ 50°C (3)	16 A @ 12 Vdc / 15 A @ 15 Vdc	5 A @ 50°C (3)	3,5 A (3)
15 A for >6 s with Uout >90% Un (4)	20...18 A for >6 s with Uout >90% Un (4)	6 A for >6 s with Uout >90% Un (4)	5 A for >6 s with Uout >90% Un (4)
38 A for 0.5 s (4)	34 A for 0.5 s (4)	18 A for 0.5 s (4)	13 A for 0.5 s (4)
< 1%	< 1%	< 1%	< 1%
≤ 100 mVpp	≤ 100 mVpp	100 mVpp	≤ 100 mVpp
>15 ms / >100 ms	>15 ms / >100 ms	>15 ms / >100 ms	>15 ms / >100 ms
hiccup at the overload limit with auto reset / over temperature protection			
"DC OK" green LED / "DC OK" alarm contact/ "Overload" red LED			
21.6 Vdc	10.8 Vdc	43.2 Vdc	64.8 Vdc
possible	possible	possible	possible
possible with external ORing diode	possible with external ORing diode	factory provided with internal ORing diode	factory provided with internal ORing diode

## GENERAL TECHNICAL DATA

Efficiency (Uin 230 / 400 Vac)
Dissipated power (Uin 230 / 400 Vac)
Operating temperature range
Input/output isolation
Input/ground isolation
Output/ground isolation
Standard/approvals
EMC Standards
MTBF @ 25°C @ nominal ratings
Overvoltage category/Pollution degree
Protection degree
Connection terminal
Housing material
Approx. weight
Mounting information

>91% / >92%
24 W / 21 W
-20...+60°C, with derating over 50°C / over temperature protection (3)
3 kVac / 60 s SELV output (5)
2 kVac / 60 s
0.5 kVac / 60 s
EN50178, EN61558, EN60950, IEC950, UL508
EN61000-6-2, EN61000-6-4, EN61000-4-2, EN61000-4-3, EN61000-4-4, EN61000-4-5, EN61000-4-6, EN61000-4-11
>500'000 h acc. to SN 29500 / >150'000 h acc. to MIL Std. HDBK 217F
II / 2
IP 20 IEC 529, EN60529
2.5 mm² pluggable screw type
aluminium and stainless steel
1 kg (35.3 oz)
vertical on rail, allow 10 mm spacing between adjacent components

## MOUNTING ACCESSORIES

Mounting rail type according to IEC60715/TH35-7.5
Mounting rail type according to IEC60715/G32

PR/3/AC, PR/3/AC/ZB, PR/3/AS, PR/3/AS/ZB
--

# 1, 2 or 3-phase switching power supply 230-400-500 Vac output power 480 W

- Single-phase, 2-phase and 3-phase input 185...550 Vac
- High reliability and immunity against over voltage due to failures on AC line
- Short circuit, overload, over temperature, input and output overvoltage protections
- High outrush current to guarantee downstream overcurrent protections selectivity and to start-up heavy loads
- High efficiency and low dissipated power
- Suitable for applications in SELV and PELV circuits

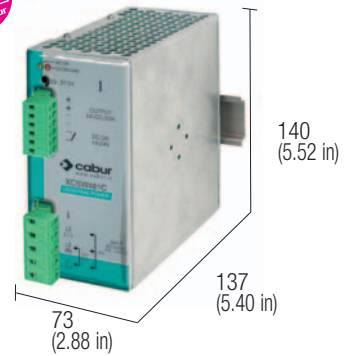

## NOTES

The depth dimension includes the terminal blocks and the DIN clamp.

- (1) Version available upon request; for information call our sales department, local agent or representative
- (2) 550 Vdc max for UL508
- (3) Over 45°C (113°F) apply a derating of about 16 W/°C
- (4) For this peak current, the output voltage does not drop more than 10% of the nominal value, but the current value, provided by the power supply also depends on the total line resistance.
- (5) Version with 72 V output is not suitable for SELV applications

## BLOCK DIAGRAM

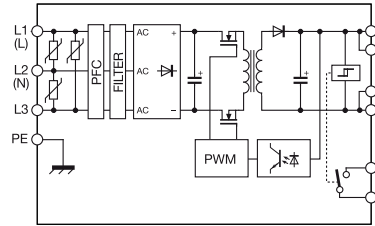

## VERSIONS

- Output 24 Vdc 20 A
- Output 12...15 Vdc 40 A
- Output 48 Vdc 10 A
- Output 72 Vdc 6 A

### Cod. XCSW481C

### Cod. XCSW481D

### XCSW481G

CSW481C

CSW481D

CSW481G (1) (5)

## INPUT

- Input rated voltage
- Frequency
- Current @ Iout max. (Uin 230 / 400 Vac)
- Inrush peak current
- Power factor
- Internal protection fuse
- External protection on AC line

1-2-3x **230-400-500 Vac** (range 187...550 Vac / 250...725 Vdc) (2)  
 47...63 Hz  
 2.2 A / 1 A  
 <20 A / <40 A  
 > 0.95  
 -  
 circuit breaker: 2-3x 6 A C characteristic - fuse: 2-3x T 6.3 A

## OUTPUT TECHNICAL DATA

- Output rated voltage
- Output adjustable range
- Continuous current
- Overload limit
- Short circuit peak current
- Load regulation
- Ripple @ nominal ratings
- Hold up time (Uin 230 / 400 Vac)
- Overload / short circuit protections
- Status display
- Alarm contact threshold
- Parallel connection
- Redundant parallel connection

	24 Vdc	48 Vdc	72 Vdc
Output rated voltage	23,3...27,5 Vdc	45...55 Vdc	72...85 Vdc
Output adjustable range	20 A @ 45°C (3)	10 A @ 45°C (3)	6 A @ 45°C (3)
Continuous current	28 A for >5 s with Uout >90%Un (4)	14 A for >5 s with Uout >90%Un (4)	9 A for >5 s with Uout >90%Un (4)
Overload limit	50 A for 0,3 s (4)	25 A for 0,3 s (4)	12 A for 0,3 s (4)
Short circuit peak current	< 1%	< 1%	< 1%
Load regulation	≤ 100 mVpp	≤ 100 mVpp	≤ 100 mVpp
Ripple @ nominal ratings	>20 ms / >20 ms	>20 ms / >20 ms	>20 ms / >20 ms
Hold up time (Uin 230 / 400 Vac)	hiccup at the overload limit with auto reset / over temperature protection		
Overload / short circuit protections	"DC OK" green LED / "DC OK" alarm contact/ "Overload" red LED		
Status display	21.6 Vdc	43.2 Vdc	64.8 Vdc
Alarm contact threshold	possible	possible	possible
Parallel connection	possible with external ORing diode	factory provided with internal ORing diode	factory provided with internal ORing diode

## GENERAL TECHNICAL DATA

- Efficiency (Uin 230 / 400 Vac)
- Dissipated power (Uin 230 / 400 Vac)
- Operating temperature range
- Input/output isolation
- Input/ground isolation
- Output/ground isolation
- Standard/approvals
- EMC Standards
- MTBF @ 25°C @ nominal ratings
- Overvoltage category/Pollution degree
- Protection degree
- Connection terminal
- Housing material
- Approx. weight
- Mounting information

>92% / >92%  
 42 W / 42 W  
 -20...+60°C, with derating over 50°C / over temperature protection (3)  
 3 kVac / 60 s SELV output (5)  
 2 kVac / 60 s  
 0.5 kVac / 60 s  
 EN50178, EN61558, EN60950, IEC950, UL508  
 EN61000-6-2, EN61000-6-4, EN61000-4-2, EN61000-4-3, EN61000-4-4, EN61000-4-5, EN61000-4-6, EN61000-4-11  
 >500'000 h acc. to SN 29500 / >150'000 h acc. to MIL Std. HDBK 217F  
 II / 2  
 IP 20 IEC 529, EN60529  
 2.5 mm² pluggable screw type  
 aluminium and stainless steel  
 1 kg (35.3 oz)  
 vertical on rail, allow 10 mm spacing between adjacent components

## MOUNTING ACCESSORIES

- Mounting rail type according to IEC60715/TH35-7.5
- Mounting rail type according to IEC60715/G32

PR/3/AC, PR/3/AC/ZB, PR/3/AS, PR/3/AS/ZB

# Switching power supply CSG series

## TRIPLE POWER

**DIN-rail 3-phase switching power supplies** specifically designed for applications in industrial automation control panels. They can deliver over +50% of the nominal current for a sustained period keeping a stable output voltage.

The alarm contact is controlled by a voltage threshold and it switches when the voltage drops below 90% of the rated value.

**Thanks to these features and to the numerous international certifications, this series of power supplies allows engineers to meet all the requirements of the new EN 60204-1 Machinery Directive**, to enable the protection devices connected to the output to trigger quickly, safely and selectively, thus ensuring continuity of service to the other parts of the system.

### Suggested uses

- Applications in machinery automation requiring high levels of reliability in terms of control and safety voltage
- In applications requiring selectivity of surge protection devices on DC lines
- Applications in industrial automation
- Heavy duty uses

### Main features

- Equipped with 340...550 Vac / 507...770 Vdc, they are suitable for use on all power lines.
- Their high efficiency reduces energy consumption and components' operating temperature allowing their use in small panels and under severe ambient conditions.
- Great backup power allowing to supply at least + 50% above the rated voltage for 5 seconds, keeping output voltage constant and ensuring safety and reliability.
- The output voltage may be adjusted and is protected against the input of surges on the DC line and is equipped with double electronic protection devices preventing damages to powered components in the event of internal faults.
- Dimensioned short-circuit and overload protection supplying breakaway starting currents 150% above the rated value required by heavy loads.
- Thermal protection prevents faults in the event of prolonged overloads at high ambient temperatures.
- Their design ensures excellent ventilation to internal components, very small dimensions and IP20 protection against accidental contacts in compliance with IEC529.

### Special power supplies for engines in DC, Brushless, and relative drives

New 48Vdc, 72-85Vdc, and 110-180Vdc models have been introduced, designed to reliably power engines in DC. They:

- Supply peak power equal to even 4-5 times the nominal current, which is required by the engine during the peak phase
- Have an output stage protected from overvoltage generated by the engines and drives during braking, which could otherwise cause malfunctions or cause the power supply to lose control over output voltage stability
- Provide output voltage at 48Vdc, and 72-85Vdc. By increasing the voltage of the engine power supply, the same power can be obtained at lower current, with notable advantages for performance, engine construction, connection wires, and drives.

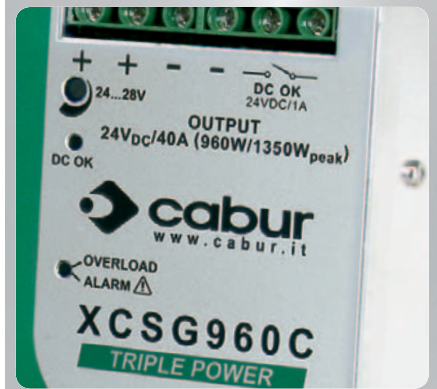

**Integrated smart alarm contact**

Activated when output voltage decreases below 90% of rated value

**Extremely compact dimensions**

They are among the smallest on the market, optimising the use of space in the panel without compromising performance

**Power boost**

The output power reaches 120% of the nominal value for several minutes, up to 150% during an overload, and up to 250% in the event of a short-circuit, to enable the protection devices connected to the output to trigger quickly, safely and selectively, without the use of additional modules

**Very high efficiency**

Designed to save energy and reduce the working temperature

**Wide range**

The widest range on the market, with power ratings from 120 to 2400W and output voltages of 24, 48 and 72 V, for uses including powering special motors

### New active electronic ASSIL protection

3-phase networks can cause reliability problems for electronic devices due to various phenomena. Simple activation of a protection or the commutation of a load can generate holes in the network and voltage peaks whose size depends on several variables.

These damaging phenomena are governed by the VDE0160-2 standard and cannot be resolved using traditional passive protections (varistors, NTC).

The solution is the active ASSIL circuit (Active Surge Suppressor and Inrush Current Limiter). A power semi-conductor "opens" the DC side in less than 0.1 ms in the case that voltage exceeds 750V, preventing damaging voltage peaks from reaching the convertor's MOSFET.

The protection circuit also serves to actively limit the inrush current, which allows for precise coordination of the overcurrent protections, as well as eliminating undesirable bursts which can occur when the network returns to its nominal value after a voltage hole.

# 3-phase switching power supply 400-500 Vac output power 480 W

- 3-phase input 340...550 Vac or 2-phase with derating
- Short circuit, overload, over temperature, input and output overvoltage protections
- High outrush current to guarantee downstream overcurrent protections selectivity and to start-up heavy loads
- High efficiency and low dissipated power
- Suitable for applications in SELV and PELV circuits

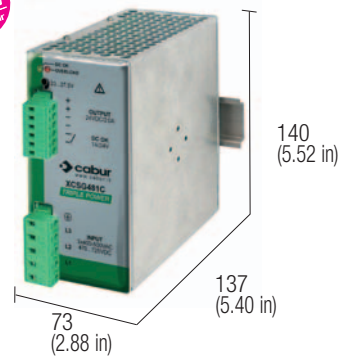

## NOTES

The depth dimension includes the DIN rail clamp.

(3) Over 50°C (122°F) apply a derating of about 6 W/°C

(4) For this peak current, the output voltage does not drop more than 10% of the nominal value, but the current value, provided by the power supply also depends on the total line resistance.

## BLOCK DIAGRAM

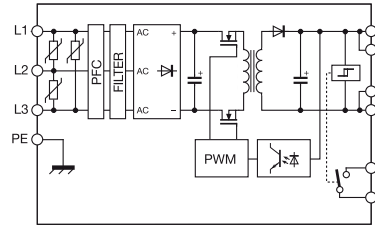

## VERSIONS

- Output 24 Vdc 20 A
- Output 12...15 Vdc 40 A
- Output 48 Vdc 10 A
- Output 72 Vdc 6 A

Cod. XCSG481C

CSG481C (5)

## INPUT TECHNICAL DATA

Input rated voltage

3x 400-500 Vac (range 340...550 Vac)

Frequency

47...63 Hz

Current @ Iout max. (Uin 400 / 500 Vac)

1,2 A / 0,8 A

Inrush peak current

<40 A

Power factor

> 0,95

Internal protection fuse

—

External protection on AC line

circuit breaker: 3x 6 A C characteristic - fuse: 3x T 6,3 A

## OUTPUT TECHNICAL DATA

Output rated voltage

24 Vdc

Output adjustable range

23,3...27,5 Vdc

Continuous current

20 A @ 45°C (3)

Overload limit

28 A for >5 s with Uout

>90%Un (4)

Short circuit peak current

50 A for 0,3 s (4)

Load regulation

< 1%

Ripple @ nominal ratings

≤ 100 mVpp

Hold up time (Uin 400 / 500 Vac)

>50 ms / >50 ms

Overload / short circuit protections

hiccup at the overload limit with auto reset / over temperature protection (3)

Status display

"DC OK" green LED / "DC OK" alarm contact

Alarm contact threshold

21,6 Vdc

Parallel connection

possible  
possible with external ORing diode

Redundant parallel connection

## GENERAL TECHNICAL DATA

Efficiency (Uin 400 / 500 Vac)

>93% / >92%

Dissipated power (Uin 400 / 500 Vac)

36 W / 42 W

Operating temperature range

-20...+60°C, with derating over 50°C / over temperature protection (3)

Input/output isolation

3 kVac / 60 s SELV output

Input/ground isolation

2 kVac / 60 s

Output/ground isolation

0.5 kVac / 60 s

Standard/approvals

EN50178, EN61558, EN60950, IEC950, UL508

EMC Standards

EN61000-6-2, EN61000-6-4, EN61000-4-2, EN61000-4-3, EN61000-4-4, EN61000-4-5, EN61000-4-6, EN61000-4-11

MTBF @ 25°C @ nominal ratings

>500'000 h acc. to SN 29500 / >150'000 h acc. to MIL Std. HDBK 217F

Overvoltage category/Pollution degree

II / 2

Protection degree

IP 20 IEC 529, EN60529

Connection terminal

4 mm<sup>2</sup> fixed screw type

Housing material

aluminium

Approx. weight

1 kg (35.3 oz)

Mounting information

vertical on rail, allow 10 mm spacing between adjacent components

## MOUNTING ACCESSORIES

Mounting rail type according to IEC60715/TH35-7.5

PR/3/AC, PR/3/AC/ZB, PR/3/AS, PR/3/AS/ZB

Mounting rail type according to IEC60715/G32



# 3-phase switching power supply 400-500 Vac output power 500 W

- 3-phase input 340...550 Vac or 2-phase with derating
- Short circuit, overload, over temperature, input and output overvoltage protections
- High outrush current to guarantee downstream overcurrent protections selectivity and to start-up heavy loads
- High efficiency and low dissipated power
- Suitable for applications in SELV and PELV circuits
- Input protected by ASSIL circuit (Surge Suppressor and Inrush Limiter)

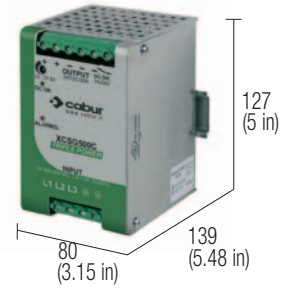

## NOTES

The depth dimension includes the DIN rail clamp.

- (1) Version available upon request; for information call our sales department, local agent or representative
- (3) Over 50°C (122°F) apply a derating of about 6 W/°C
- (4) For this peak current, the output voltage does not drop more than 10% of the nominal value, but the current value, provided by the power supply also depends on the total line resistance.
- (5) Version CSG500G is not suitable for SELV applications

## BLOCK DIAGRAM

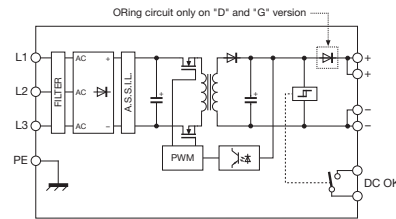

Special version for DC motors

Special version for DC motors

VERSIONS	Cod. XCSG500C		Cod. XCSG500D		Cod. XCSG500G	
	CSG500C		CSG500D (1)		CSG500G (1) (5)	
Output 24 Vdc 20 A						
Output 12...15 Vdc 40 A						
Output 48 Vdc 10 A redundant version						
Output 72 Vdc 6.7 A redundant version						
INPUT TECHNICAL DATA	3x 400-500 Vac (range 340...550 Vac)					
Input rated voltage	47...63 Hz					
Frequency	1 A / 0.6 A					
Current @ Iout max. (Uin 400 / 500 Vac)	< 35 A					
Current @ Iout max. (Uin 400 / 500 Vac)	> 0.75 with PFC					
Continuous current	—					
Overload limit	circuit breaker: 10 A characteristic - fuse: 3x T 10 A					
Inrush peak current	<b>24 Vdc</b>		<b>48 Vdc</b>		<b>72 Vdc</b>	
Power factor	24...28 Vdc		45...55 Vdc		72...85 Vdc	
Internal protection fuse	20 A @ 50°C (3)		10 A @ 50°C (3)		6.7 A @ 50°C (3)	
External protection on AC line	>30 A for >5 s with Uout >90% Un (4)		>15 A for >5 s with Uout >90% Un (4)		10 A for >5 s with Uout >90% Un (4)	
OUTPUT TECHNICAL DATA	>60 A for 5 s (4)		>30 A for 5 s (4)		>20 A for 5 s (4)	
Output rated voltage	< 0.5%		< 0.5%		< 1%	
Output adjustable range	≤ 100 mVpp		≤ 100 mVpp		≤ 100 mVpp	
Continuous current	>15 ms / >30 ms		>15 ms / >20 ms		>15 ms / >20 ms	
Overload limit	hiccup at the overload limit with auto reset / over temperature protection / ASSIL circuit					
Short circuit peak current	"DC OK" green LED / "DC OK" alarm contact/ "Overload" red LED					
Load regulation	<21.6 Vdc		<43.2 Vdc		<64.8 Vdc	
Ripple @ nominal ratings	possible		possible		possible	
Hold up time (Uin 400 / 500 Vac)	possible with external ORing diode		factory provided with internal ORing diode		factory provided with internal ORing diode	
Overload / short circuit protections						
Status display						
Alarm contact threshold						
Parallel connection						
Redundant parallel connection						
GENERAL TECHNICAL DATA	>94% / >94%		>94% / >94%		>95% / >95%	
Efficiency (Uin 400 / 500 Vac)	30 W / 30 W		30 W / 30 W		26 W / 26 W	
Dissipated power (Uin 400 / 500 Vac)	-20...+60°C, with derating over 50°C / over temperature protection (3)					
Operating temperature range	3 kVac / 60 s SELV output (5)					
Input/output isolation	2 kVac / 60 s					
Input/ground isolation	0.5 kVac / 60 s					
Output/ground isolation	EN50178, EN61558, EN60950, IEC950, UL508					
Standard/approvals	EN61000-6-2, EN61000-6-4, EN61000-4-2, EN61000-4-3, EN61000-4-4, EN61000-4-5, EN61000-4-6, EN61000-4-11					
EMC Standards	>500'000 h acc. to SN 29500 / >150'000 h acc. to MIL Std. HDBK 217F					
MTBF @ 25°C @ nominal ratings	II / 2					
Overvoltage category/Pollution degree	IP 20 IEC 529, EN60529					
Protection degree	6 mm² fixed screw type					
Connection terminal	aluminium					
Housing material	1.3 kg (45.89 oz)					
Approx. weight	vertical on rail, allow 10 mm spacing between adjacent components					
Mounting information						
MOUNTING ACCESSORIES	PR/3/AC, PR/3/AC/ZB, PR/3/AS, PR/3/AS/ZB					
Mounting rail type according to IEC60715/TH35-7.5						
Mounting rail type according to IEC60715/G32						

# 3-phase switching power supply 400-500 Vac output power 720 W

- 3-phase input 340...550 Vac or 2-phase with derating
- Short circuit, overload, over temperature, input and output overvoltage protections
- High outrush current to guarantee downstream overcurrent protections selectivity and to start-up heavy loads
- High efficiency and low dissipated power
- Suitable for applications in SELV and PELV circuits
- Input protected by ASSIL circuit (Surge Suppressor and Inrush Limiter)

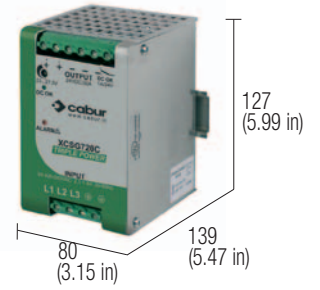

## NOTES

The depth dimension includes the DIN rail clamp.

- (1) Version available upon request; for information call our sales department, local agent or representative
- (3) Over 50°C (122°F) apply a derating of about 6 W/°C
- (4) For this peak current, the output voltage does not drop more than 10% of the nominal value, but the current value, provided by the power supply also depends on the total line resistance.

## BLOCK DIAGRAM

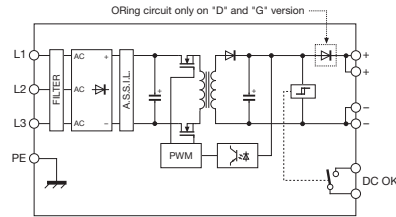

Special version for DC motors

## VERSIONS

- Output 24 Vdc 30 A
- Output 12...15 Vdc 60 A
- Output 48 Vdc 15 A redundant version
- Output 72 Vdc 10 A redundant version

Cod. XCSG720C

CSG720C

(1)

CSG720D

(1)

## INPUT TECHNICAL DATA

- Input rated voltage
- Frequency
- Current @ Iout max. (Uin 400 / 500 Vac)
- Inrush peak current
- Power factor
- Internal protection fuse
- External protection on AC line

3x **400-500 Vac** (range 340...550 Vac)  
47...63 Hz  
1.4 A / 1.1 A  
< 30 A  
> 0.75

circuit breaker: 3x 10 A C characteristic - fuse: 3x T 10 A

## OUTPUT TECHNICAL DATA

- Output rated voltage
- Output adjustable range
- Continuous current
- Overload limit
- Short circuit peak current
- Load regulation
- Ripple @ nominal ratings
- Hold up time (Uin 400 / 500 Vac)
- Overload / short circuit protections

	24 Vdc	48 Vdc
Output rated voltage	24...28 Vdc	45...55 Vdc
Output adjustable range	24...28 Vdc	45...55 Vdc
Continuous current	<b>30 A @ 50°C (3)</b>	<b>15 A @ 50°C (3)</b>
Overload limit	45 A for >5 s with Uout >90% Un (4)	22.5 A for >5 s with Uout >90% Un (4)
Short circuit peak current	>80 A for 1.5 s (4)	>45 A for 1.5 s (4)
Load regulation	< 1%	< 1%
Ripple @ nominal ratings	100 mVpp	100 mVpp
Hold up time (Uin 400 / 500 Vac)	>10 ms / >15 ms	>10 ms / >15 ms

hiccup at the overload limit with auto reset / over temperature protection / ASSIL circuit

"DC OK" green LED / "DC OK" alarm contact/ "Overload" red LED

- Alarm contact threshold
- Parallel connection
- Redundant parallel connection

Alarm contact threshold	<21.6 Vdc	<43.2 Vdc
Parallel connection	possible	possible
Redundant parallel connection	possible with external ORing diode	factory provided with internal ORing diode

## GENERAL TECHNICAL DATA

- Efficiency (Uin 400 / 500 Vac)
- Dissipated power (Uin 400 / 500 Vac)
- Operating temperature range
- Input/output isolation
- Input/ground isolation
- Output/ground isolation
- Standard/approvals
- EMC Standards
- MTBF @ 25°C @ nominal ratings
- Overvoltage category/Pollution degree
- Protection degree
- Connection terminal
- Housing material
- Approx. weight
- Mounting information

Efficiency (Uin 400 / 500 Vac)	>92% / >92%	>93% / >93%
Dissipated power (Uin 400 / 500 Vac)	60 W / 60 W	55 W / 55 W
Operating temperature range	-20...+60°C, with derating over 50°C / over temperature protection (3)	
Input/output isolation	3 kVac / 60 s SELV output	
Input/ground isolation	2 kVac / 60 s	
Output/ground isolation	0.5 kVac / 60 s	
Standard/approvals	EN50178, EN61558, EN60950, IEC950, UL508	
EMC Standards	EN61000-6-2, EN61000-6-4, EN61000-4-2, EN61000-4-3, EN61000-4-4, EN61000-4-5, EN61000-4-6, EN61000-4-11	
MTBF @ 25°C @ nominal ratings	>500'000 h acc. to SN 29500 / >150'000 h acc. to MIL Std. HDBK 217F	
Overvoltage category/Pollution degree	II / 2	
Protection degree	IP 20 IEC 529, EN60529	
Connection terminal	6 mm <sup>2</sup> fixed screw type	
Housing material	aluminium	
Approx. weight	1.3 kg (45.86 oz)	
Mounting information	vertical on rail, allow 10 mm spacing between adjacent components	

## MOUNTING ACCESSORIES

- Mounting rail type according to IEC60715/TH35-7.5
- Mounting rail type according to IEC60715/G32

PR/3/AC, PR/3/AC/ZB, PR/3/AS, PR/3/AS/ZB

# 3-phase switching power supply 400-500 Vac output power 960 W

- 3-phase input 340...550 Vac or 2-phase with derating
- Short circuit, overload, over temperature, input and output overvoltage protections
- High outrush current to guarantee downstream overcurrent protections selectivity and to start-up heavy loads
- High efficiency and low dissipated power
- Suitable for applications in SELV and PELV circuits
- Input protected by ASSIL circuit (Surge Suppressor and Inrush Limiter)

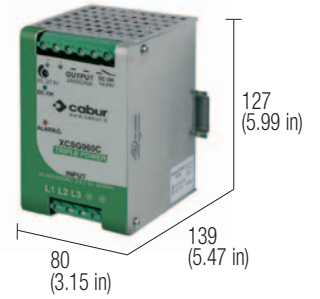

## NOTES

The depth dimension includes the DIN rail clamp.

- (3) Over 50°C (122°F) apply a derating of about 18 W/°C
- (4) For this peak current, the output voltage does not drop more than 10% of the nominal value, but the current value, provided by the power supply also depends on the total line resistance.
- (5) Version CSG960G is not suitable for SELV applications

## BLOCK DIAGRAM

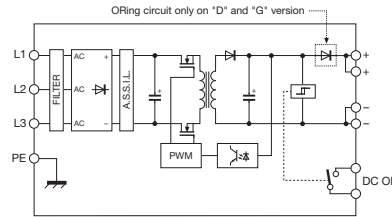

Special version for DC motors

Special version for DC motors

VERSIONS	Cod. XCSG960C	Cod. XCSG960D	Cod. XCSG960G
Output 24 Vdc 40 A	CSG960C	—	—
Output 12...15 Vdc 80 A	—	—	—
Output 48 Vdc 20 A redundant version	—	CSG960D	—
Output 72 Vdc 13.3 A redundant version	—	—	CSG960G (5)
INPUT TECHNICAL DATA	3x 400-500 Vac (range 340...550 Vac)		
Input rated voltage	47...63 Hz		
Frequency	2.2 A / 1.1 A		
Current @ Iout max. (Uin 400 / 500 Vac)	< 20 A		
Inrush peak current	> 0.65		
Power factor	—		
Internal protection fuse	circuit breaker: 3x 10 A C characteristic - fuse: 3x T 10 A		
External protection on AC line	—		
OUTPUT TECHNICAL DATA	<b>24 Vdc</b>	<b>48 Vdc</b>	<b>72 Vdc</b>
Output rated voltage	24...28 Vdc	45...55 Vdc	72...85 Vdc
Output adjustable range	<b>40 A @ 50°C (3)</b>	<b>20 A @ 50°C (3)</b>	<b>13.3 A @ 50°C (3)</b>
Continuous current	56 A for >5 s	28 A for >5 s	18.6 A for >5 s
Overload limit	with Uout >90% Un (4)	with Uout >90% Un (4)	with Uout >90% Un (4)
Short circuit peak current	>90 A for 5 s (4)	>70 A for 5 s (4)	>30 A for 5 s (4)
Load regulation	< 1%	< 1%	< 1%
Ripple @ nominal ratings	100 mVpp	100 mVpp	≤ 100 mVpp
Hold up time (Uin 400 / 500 Vac)	>10 ms / >15 ms	>10 ms / >15 ms	>15 ms / >18 ms
Overload / short circuit protections	hiccup at the overload limit with auto reset / over temperature protection		
Status display	"DC OK" green LED / "DC OK" alarm contact/ "Overload" red LED		
Alarm contact threshold	<21.6 Vdc	<43.2 Vdc	<64.8 Vdc
Parallel connection	possible	possible	possible
Redundant parallel connection	possible with external ORing diode	factory provided with internal ORing diode	factory provided with internal ORing diode
GENERAL TECHNICAL DATA	>94% / >94%	>94% / >94%	>92% / >92%
Efficiency (Uin 400 / 500 Vac)	61 W / 61 W	61 W / 61 W	85 W / 85 W
Dissipated power (Uin 400 / 500 Vac)	-20...+60°C, with derating over 50°C / over temperature protection (3)		
Operating temperature range	3 kVac / 60 s SELV output (5)		
Input/output isolation	2 kVac / 60 s		
Input/ground isolation	0.5 kVac / 60 s		
Output/ground isolation	EN50178, EN61558, EN60950, IEC950, UL508		
Standard/approvals	EN61000-6-2, EN61000-6-4, EN61000-4-2, EN61000-4-3, EN61000-4-4, EN61000-4-5, EN61000-4-6, EN61000-4-11		
EMC Standards	>500'000 h acc. to SN 29500 / >150'000 h acc. to MIL Std. HDBK 217F		
MTBF @ 25°C @ nominal ratings	II / 2		
Overvoltage category/Pollution degree	IP 20 IEC 529, EN60529		
Protection degree	6 mm² fixed screw type		
Connection terminal	aluminium		
Housing material	1,2 kg (70.55 oz)		
Approx. weight	vertical on rail, allow 10 mm spacing between adjacent components		
Mounting information	<b>PR/3/AC, PR/3/AC/ZB, PR/3/AS, PR/3/AS/ZB</b>		
MOUNTING ACCESSORIES	—		
Mounting rail type according to IEC60715/TH35-7.5	—		
Mounting rail type according to IEC60715/G32	—		



# 3-phase switching power supply 400-500 Vac output power 2400 W

- 3-phase input 340...550 Vac or 2-phase with derating
- Short circuit, overload, over temperature, input and output overvoltage protections
- High outrush current to guarantee downstream overcurrent protections selectivity and to start-up heavy loads
- High efficiency and low dissipated power
- Suitable for applications in SELV and PELV circuits
- Input protected by ASSIL circuit (Surge Suppressor and Inrush Limiter)

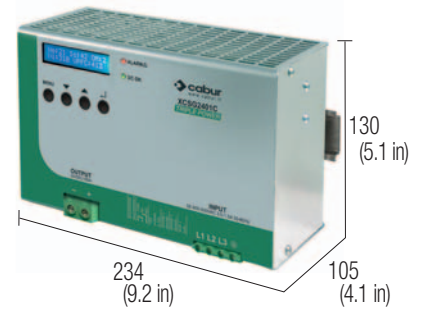

UL pending



## NOTES

- The depth dimension includes the DIN rail clamp.
- (2) Version available upon request; for information call our sales department, local agent or representative
- (3) Over 45°C (113°F) apply a derating of about 40 W/°C
- (4) For this peak current, the output voltage does not drop more than 10% of the nominal value, but the current value, provided by the power supply also depends on the total line resistance.

## BLOCK DIAGRAM

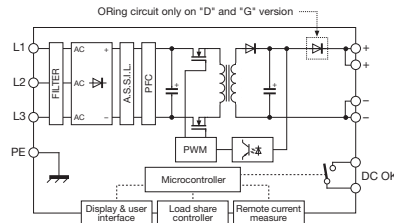

Special version for DC motors

## VERSIONS

- Output 12-15-24 Vdc 100 A redundant version
- Output 24-48 Vdc 50 A redundant version

Cod. XCSG2401C

Cod. XCSG2401D

CSG2401C (2)

CSG2401D (2)

## INPUT TECHNICAL DATA

- Input rated voltage
- Frequency
- Current @ Iout max. (Uin 400 / 500 Vac)
- Inrush peak current
- Power factor
- Internal protection fuse
- External protection on AC line

- 3x 400-500 Vac (range 340...550 Vac)
- 47...63 Hz
- 4.2 A / 3.5 A
- < 2 A (with active inrush current limiter)
- > 0.92
- 
- circuit breaker: 3x 10 A C characteristic - fuse: 3x T10 A

## OUTPUT TECHNICAL DATA

- Output rated voltage
- Output adjustable range
- Continuous current
- Overload limit
- Short circuit peak current
- Load regulation
- Ripple @ nominal ratings
- Hold up time (Uin 400 / 500 Vac)
- Overload / short circuit protections
- Status display

- | 12-15-24 Vdc                         | 24-48 Vdc                           |
|--------------------------------------|-------------------------------------|
| 11.5...29 Vdc                        | 23...56 Vdc                         |
| 100 A @ 45°C (3)                     | 50 A @ 45°C (3)                     |
| 150 A for >5 s with Uout >90% Un (4) | 75 A for >5 s with Uout >90% Un (4) |
| >150 A for 5 s (4)                   | >75 A for 5 s (4)                   |
| < 1%                                 | < 1%                                |
| ≤ 200 mVpp                           | ≤ 200 mVpp                          |
| >10 ms / >10 ms                      | >10 ms / >10 ms                     |

- Alarm contact threshold
- Parallel connection
- Redundant parallel connection

- programmable (see on right side)
- "DC OK" green LED / "DC OK" alarm contact / "Overload" red LED / LCD display
- programmable (see on right side)
- possible
- possible

## GENERAL TECHNICAL DATA

- Efficiency (Uin 400 / 500 Vac)
- Dissipated power (Uin 400 / 500 Vac)
- Operating temperature range
- Input/output isolation
- Input/ground isolation
- Output/ground isolation
- Standard/approvals
- EMC Standards
- MTBF @ 25°C @ nominal ratings
- Overvoltage category/Pollution degree
- Protection degree
- Connection terminal
- Housing material
- Approx. weight
- Mounting information

- >92% / >92%
- >93% / >93%
- 200 W / 200 W
- 180 W / 180 W
- 20...+60°C, with derating over 45°C / over temperature protection (3)
- 3 kVac / 60 s SELV output (5)
- 1.5 kVac / 60 s
- 0.5 kVac / 60 s
- EN60950, IEC950
- EN 55011, EN 61000-3-2, EN61000-4-5
- Surge immunity Level IV, VDE0160
- >500'000 h acc. to SN 29500 / >150'000 h acc. to MIL Std. HDBK 217F
- II / 2
- IP 20 IEC529, EN60529
- 4-6 mm² fixed screw type
- aluminium
- 2,8 kg (98,76 oz)
- vertical on rail, allow 60 mm spacing between adjacent components

## MOUNTING ACCESSORIES

- Mounting rail type according to IEC60715/TH35-7.5
- Mounting rail type according to IEC60715/G32

PR/3/AC, PR/3/AC/ZB, PR/3/AS, PR/3/AS/ZB

## APPLICATIONS

Series CSG2401 has an internal microprocessor that controls the many functions of the power supply, which can be programmed thanks to a user-friendly menu activated by 4 buttons on the front and shown on the front display.

**Front display:** during normal operation, this shows the output voltage value and current used by the load; during programming, it allows for the choice of the various functions available.

**Input protection:** the input circuit has been designed to avoid the most common problems seen in 3-phase networks. It therefore has:

- 1) a special ASSIL (Active Surge Suppressor and Inrush Limiter) circuit to protect it against overvoltage in accordance with VDE0160;
- 2) a PFC circuit failure (latched shutdown) circuit;
- 3) a system for controlling lack of phase that automatically reduces output power;
- 4) an auto-restart switch-off system in the event of overvoltage and undervoltage.

**Output protection:** limit current can be selected as between 10% and 100% of rated current; protection type against overload and short circuit can be chosen from:

- 1) hiccup autoreset with limit current, equal to 150% of rated current and ON/OFF time equal to 5 secs./10 secs. (values can be altered manually);
- 2) constant power.

**Output signals:** in addition to the "DC OK" and "FAULT" LEDs, the device also has:

- 1) an analogue signal 0...10V or 4...20mA that provides an indication of current used by the load;
- 2) a programmable alarm contact able to signal and record the exceeding of the various limits to a memory: output voltage, input current, output overload, overtemperature and other parameters that can be defined by programming.

**Additional functions:** the following functions are also available:

- 1) battery charger: the acid lead battery charging function can be selected;
- 2) remote sensing (sense): this allows for the monitoring and compensation of voltage drops on long power supply lines;
- 3) remote switch-off: the power supply can be switched off and disabled from a remote position;
- 4) auxiliary voltage: auxiliary 12 Vdc is also available, regardless of the main output voltage status;
- 5) temperature control: by connecting an external sensor (NTC), the battery charge temperature can be controlled;
- 6) communication port: by means of an RS232 communication device, the power supply can be piloted and monitored from a remote position.

# 3-phase switching power supply 400-500 Vac output power 2400 W

- 3-phase input 340...550 Vac or 2-phase with derating
- Short circuit, overload, over temperature, input and output overvoltage protections
- High outrush current to guarantee downstream overcurrent protections selectivity and to start-up heavy loads
- High efficiency and low dissipated power
- Suitable for applications in PELV circuits
- Input protected by ASSIL circuit (Surge Suppressor and Inrush Limiter)

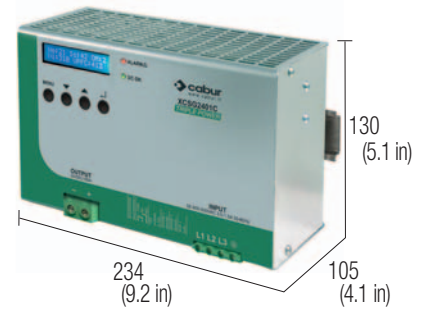

UL pending



## NOTES

- The depth dimension includes the DIN rail clamp.  
 With DC input voltage, the output current must be derated by 30%  
 (2) Version available upon request; for information call our sales department, local agent or representative  
 (3) Over 45°C (113°F) apply a derating of about 40 W/°C  
 (4) For this peak current, the output voltage does not drop more than 10% of the nominal value, but the current value, provided by the power supply also depends on the total line resistance.  
 (5) Version CSG2401G and CSG2401R is not suitable for SELV applications

## BLOCK DIAGRAM

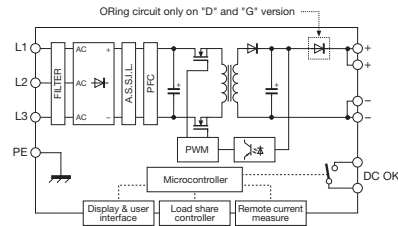

Special version for DC motors

## VERSIONI

- Output 72 Vdc 33 A redundant version (5)
- Output 100-110-170 Vdc 14 A redundant version (5)

Cod. XCSG2401G

Cod. XCSG2401R

CSG2401G (5) (2)

CSG2401R (5) (2)

## INPUT TECHNICAL DATA

- Input rated voltage
- Frequency
- Current @ Iout max. (Uin 400 / 500 Vac)
- Inrush peak current
- Power factor
- Internal protection fuse
- External protection on AC line

- 3x 400-500 Vac (range 340...550 Vac)
- 47...63 Hz
- 4.2 A / 3.5 A
- < 2 A (with active inrush current limiter)
- > 0.92
- 
- circuit breaker: 3x 10 A C characteristic - fuse: 3x T10 A

## OUTPUT TECHNICAL DATA

- Output rated voltage
- Output adjustable range
- Continuous current
- Overload limit
- Short circuit peak current
- Load regulation
- Ripple @ nominal ratings
- Hold up time (Uin 400 / 500 Vac)
- Overload / short circuit protections
- Status display

- | 72 Vdc                             | 100-110-170 Vdc                    |
|------------------------------------|------------------------------------|
| 50...87 Vdc                        | 88...175 Vdc                       |
| <b>33 A @ 45°C (3)</b>             | <b>14 A @ 45°C (3)</b>             |
| 50 A for >5 s with Uout>90% Un (4) | 21 A for >5 s with Uout>90% Un (4) |
| >50 A for 5 s (4)                  | >21 A for 5 s (4)                  |
| < 1%                               | < 1%                               |
| ≤ 200 mVpp                         | ≤ 200 mVpp                         |
| >10 ms / >10 ms                    | >10 ms / >10 ms                    |

- Alarm contact threshold
- Parallel connection
- Redundant parallel connection

- programmable (see on right side)
- "DC OK" green LED / "DC OK" alarm contact/ "Overload" red LED / LCD display (see on right side)
- programmable
- possible
- possible

## GENERAL TECHNICAL DATA

- Efficiency (Uin 400 / 500 Vac)
- Dissipated power (Uin 400 / 500 Vac)
- Operating temperature range
- Input/output isolation
- Input/ground isolation
- Output/ground isolation
- Standard/approvals
- EMC Standards
- MTBF @ 25°C @ nominal ratings
- Overvoltage category/Pollution degree
- Protection degree
- Connection terminal
- Housing material
- Approx. weight
- Mounting information

- >92% / >92%
- 200 W / 200 W
- 20...+60°C, with derating over 45°C / over temperature protection (3)
- 3 kVac / 60 s SELV output (5)
- 1.5 kVac / 60 s
- 0.5 kVac / 60 s
- EN60950, IEC950
- EN 55011, EN 61000-3-2, EN61000-4-5
- Surge immunity Level IV, VDE0160
- >500'000 h acc. to SN 29500 / >150'000 h acc. to MIL Std. HDBK 217F
- II / 2
- IP 20 IEC529, EN60529
- 4 and 6 mm<sup>2</sup> screw type
- aluminium
- 2,8 kg (98,76 oz)
- vertical on rail, allow 60 mm spacing between adjacent components

## MOUNTING ACCESSORIES

- Mounting rail type according to IEC60715/TH35-7.5
- Mounting rail type according to IEC60715/G32

PR/3/AC, PR/3/AC/ZB, PR/3/AS, PR/3/AS/ZB

## APPLICATIONS

Series CSG2401 has an internal microprocessor that controls the many functions of the power supply, which can be programmed thanks to a user-friendly menu activated by 4 buttons on the front and shown on the front display.

**Front display:** during normal operation, this shows the output voltage value and current used by the load; during programming, it allows for the choice of the various functions available.

**Input protection:** the input circuit has been designed to avoid the most common problems seen in 3-phase networks. It therefore has:

- 1) a special ASSIL (Active Surge Suppressor and Inrush Limiter) circuit to protect it against overvoltage in accordance with VDE0160;
- 2) a PFC circuit failure (latched shutdown) circuit;
- 3) a system for controlling lack of phase that automatically reduces output power;
- 4) an auto-restart switch-off system in the event of overvoltage and undervoltage.

**Output protection:** limit current can be selected as between 10% and 100% of rated current; protection type against overload and short circuit can be chosen from:

- 1) hiccup autoreset with limit current, equal to 150% of rated current and ON/OFF time equal to 5 secs./10 secs. (values can be altered manually);
- 2) constant power.

**Output signals:** in addition to the "DC OK" and "FAULT" LEDs, the device also has:

- 1) an analogue signal 0...10V or 4...20mA that provides an indication of current used by the load;
- 2) a programmable alarm contact able to signal and record the exceeding of the various limits to a memory: output voltage, input current, output overload, overtemperature and other parameters that can be defined by programming.

**Additional functions:** the following functions are also available:

- 1) battery charger: the acid lead battery charging function can be selected;
- 2) remote sensing (sense): this allows for the monitoring and compensation of voltage drops on long power supply lines;
- 3) remote switch-off: the power supply can be switched off and disabled from a remote position;
- 4) auxiliary voltage: auxiliary 12 Vdc is also available, regardless of the main output voltage status;
- 5) temperature control: by connecting an external sensor (NTC), the battery charge temperature can be controlled;
- 6) communication port: by means of an RS232 communication device, the power supply can be piloted and monitored from a remote position.

# DC/DC Insulated converters output power 120 W



- DC wide range input
- Short circuit, overload, over temperature protection
- Compact design

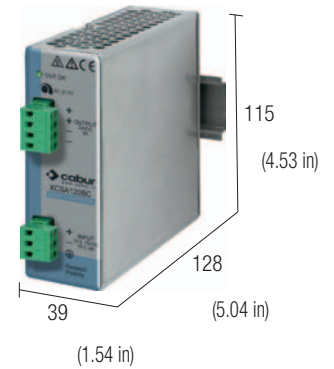

## NOTES

The depth dimension includes the terminal blocks and the DIN clamp.

- (1) Inrush current is measured with input supplied by a battery; the current peak vary depending on the internal impedance of the current source and depending on cables and connections resistance.
- (2) According to EN60950 insulation tests on input side must be made only with DC instruments.
- (3) Version available upon request; for information call our sales department, local agent or representative.

## BLOCK DIAGRAM

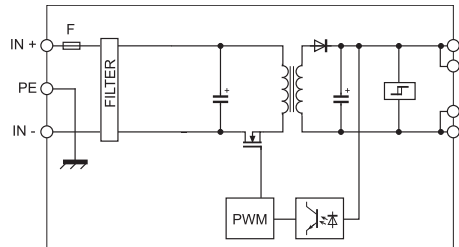

## VERSIONS

- 12 Vdc / 24 Vdc 5 A
- 12 Vdc / 48 Vdc 2.5 A
- 24 Vdc / 12 Vdc 7 A
- 24 Vdc / 24 Vdc 5 A

## INPUT TECHNICAL DATA

- Input rated voltage
- Current @ Iout max.
- Inrush peak current
- Standby power
- Internal protection fuse
- External protection on AC line
- Overvoltage input protection circuit

## OUTPUT TECHNICAL DATA

- Output rated voltage
- Output adjustable range
- Continuous current
- Overload limit
- Short circuit peak current
- Load regulation
- Ripple @ nominal ratings
- Hold up time @ In
- Overload / short circuit protections
- Status display
- Alarm contact threshold
- Parallel connection

Redundant parallel connection

## GENERAL TECHNICAL DATA

- Efficiency (Uin 110 Vdc)
- Dissipated power (Uin 110 Vdc)
- Operating temperature range
- Input/output isolation
- Input/ground isolation
- Output/ground isolation
- Standard/approvals
- EMC Standards
- MTBF @ 25°C @ nominal ratings
- Overvoltage category/Pollution degree
- Protection degree
- Connection terminal
- Housing material
- Approx. weight
- Mounting information

## MOUNTING ACCESSORIES

- Mounting rail type according to IEC60715/TH35-7.5
- Mounting rail type according to IEC60715/G32

Cod. XCSA120BC	Cod. XCSA120BD	Cod. XCSA120CB	Cod. XCSA120CC
CSA120BC (3)	CSA120BD (3)	CSA120CB	CSA120CC

12 Vdc (range 10.5...18 Vdc)	12 Vdc (range 10.5...18 Vdc)	24 Vdc (range 18...36 Vdc)	24 Vdc (range 18...36 Vdc)
10 A ± 10%	12 A ± 10%	5.1 A ± 10%	5.8 A ± 10%
< 60A / < 2ms (1)	< 60A / < 2ms (1)	< 110A / < 2ms (1)	< 90A / < 2ms (1)
< 1.5 W @ 12 Vdc	< 1.5 W @ 12 Vdc	< 1 W @ 24 Vdc	< 1.5 W @ 24 Vdc
T 20 A replaceable ≥ 25 A C characteristic		T 10 A replaceable ≥ 13 A C characteristic	
Passive varistor and active shutdown at 19 Vdc		Passive varistor and active shutdown at 38 Vdc	

24 Vdc	48 Vdc	12...15 Vdc	24 Vdc
22.5...27.5 Vdc	45...55 Vdc	12...15 Vdc	22.5...27.5 Vdc
5 A @ 24 Vdc	2.5 A @ 48 Vdc	7 A @ 12 Vdc	5 A @ 24 Vdc
6.5 A	3.4 A	9.1 A	6.5 A
12 A for 300 ms	5.8 A for 300 ms	15 A for 300 ms	12 A for 300 ms
< 0.5%		< 0.5%	
≤ 100 mVpp		≤ 100 mVpp	
> 1 ms		> 2 ms	
hiccup at the overload limit with auto reset / over temperature protection			
"DC OK" green LED			
—			
possible			
possible with external ORing diode			

> 83%	> 83%	> 87%	> 87%
< 25 W	< 25 W	< 16 W	< 18 W
-20...+50°C			
2.1 kVdc / 60s (2)			
1.41 kVdc / 60s (2)			
0.75 kVdc / 60s (2)			
IEC950, EN60950			
EN50081-1, EN50082-2, EN61000-3-2			
> 500'000 h acc. to SN 29500 / > 150'000 h acc. to MIL Std. HDBK 217F			
II / 2			
IP 20 IEC 529, EN60529			
2.5 mm <sup>2</sup> pluggable screw type			
aluminium			
550 g (19.40 oz)			
vertical on rail, allow 10 mm spacing between adjacent components			

PR/3/AC, PR/3/AC/ZB, PR/3/AS, PR/3/AS/ZB

# DC/DC Insulated converters output power 120 W



- DC wide range input
- Short circuit, overload, over temperature protection
- Compact design

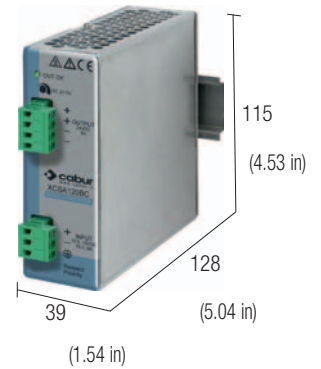

## NOTES

The depth dimension includes the terminal blocks and the DIN clamp.

- (1) Inrush current is measured with input supplied by a battery; the current peak vary depending on the internal impedance of the current source and depending on cables and connections resistance.
- (2) According to EN60950 insulation tests on input side must be made only with DC instruments.
- (3) Version available upon request; for information call our sales department, local agent or representative

## BLOCK DIAGRAM

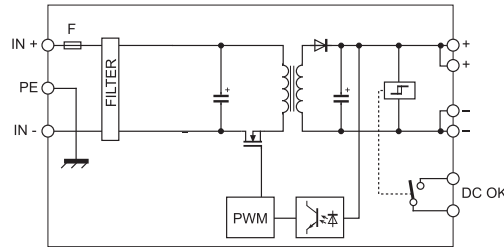

## VERSIONS

**48 Vdc / 12 Vdc 8 A**  
**48 Vdc / 24 Vdc 5 A**

**Cod. XCSA120DB**

**Cod. XCSA120DC**

**CSA120DB (3)**

**CSA120DC**

## INPUT TECHNICAL DATA

Input rated voltage  
Current @ Iout max.  
Inrush peak current  
Standby power  
Internal protection fuse  
External protection on AC line  
Overvoltage input protection circuit

**48 Vdc** (range 36...72 Vdc)  
2.8 A  $\pm 10\%$   
< 120A / < 2ms (1)  
< 2 W @ 48 Vdc

**48 Vdc** (range 36...72 Vdc)  
2.8 A  $\pm 10\%$   
< 120A / < 2ms (1)  
< 2 W @ 48 Vdc

T 5 A replaceable

$\geq 6$  A C characteristic

Passive varistor and active shutdown at 76 Vdc

## OUTPUT TECHNICAL DATA

Output rated voltage  
Output adjustable range  
Continuous current  
Overload limit  
Short circuit peak current  
Load regulation  
Ripple @ nominal ratings  
Hold up time @ In  
Overload / short circuit protections  
Status display  
Alarm contact threshold  
Parallel connection

**12...15 Vdc**

**24 Vdc**

12...15 Vdc

22.5...27.5 Vdc

8 A @ 12 Vdc

5A @ 24 Vdc

Overload limit

Short circuit peak current

Load regulation

Ripple @ nominal ratings

Hold up time @ In

Overload / short circuit protections

Status display

Alarm contact threshold

Parallel connection

12 A

6.5 A

18 A for 300 ms

13 A for 300 ms

< 0.5%

< 0.5%

$\leq 100$  mVpp

$\leq 200$  mVpp

2 ms

4.5 ms

hiccup at the overload limit with auto reset / over temperature protection

"DC OK" green LED

—

possible

Redundant parallel connection

possible with external ORing diode

## GENERAL TECHNICAL DATA

Efficiency (Uin 110 Vdc)  
Dissipated power (Uin 110 Vdc)  
Operating temperature range  
Input/output isolation  
Input/ground isolation  
Output/ground isolation  
Standard/approvals  
EMC Standards  
MTBF @ 25°C @ nominal ratings  
Overvoltage category/Pollution degree  
Protection degree  
Connection terminal  
Housing material  
Approx. weight  
Mounting information

> 89%

> 90%

< 17 W

< 13 W

Operating temperature range

-20...+60°C, with derating over 50°C

Input/output isolation

2.1 kVdc / 60s (2)

Input/ground isolation

1.41 kVdc / 60s (2)

Output/ground isolation

0.75 kVdc / 60s (2)

Standard/approvals

IEC950, EN60950

EMC Standards

EN61000-6-2, EN61000-6-4, EN61000-4-2, EN61000-4-3, EN61000-4-4, EN61000-5-5, EN61000-4-6, EN61000-4-11

MTBF @ 25°C @ nominal ratings

> 500'000 h acc. to SN 29500 / > 150'000 h acc. to MIL Std. HDBK 217F

Overvoltage category/Pollution degree

II / 2

Protection degree

IP 20 IEC 529, EN60529

Connection terminal

2.5 mm<sup>2</sup> pluggable screw type

Housing material

aluminium

Approx. weight

550 g (19.40 oz)

Mounting information

vertical on rail, allow 10 mm spacing between adjacent components

## MOUNTING ACCESSORIES

Mounting rail type according to IEC60715/TH35-7.5  
Mounting rail type according to IEC60715/G32

**PR/3/AC, PR/3/AC/ZB, PR/3/AS, PR/3/AS/ZB**

# DC/DC Insulated converters output power 240 W

- DC wide range input
- Short circuit, overload, over temperature protection
- Already preset with internal ORing diode for redundant connection
- Compact design

**NOTE:**  
also the power supplies CSD, CSF30, CSF85  
and CSF120 series can be supplied in DC 110 V

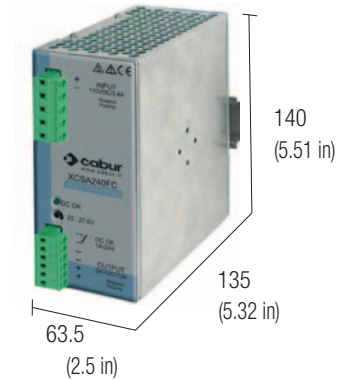

## NOTES

The depth dimension includes the terminal blocks and the DIN clamp.

- (1) Inrush current is measured with input supplied by a battery; the current peak vary depending on the internal impedance of the current source and depending on cables and connections resistance.
- (2) Over 50°C (122°F) apply a derating -6 W/°C, max 60°C
- (3) According to EN60950 insulation tests on input side must be made only with DC instruments.

## BLOCK DIAGRAM

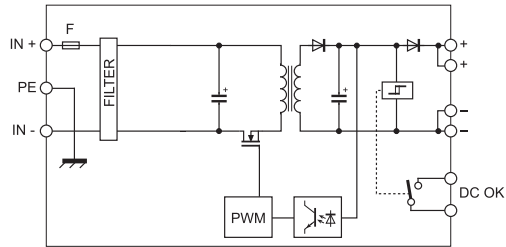

## VERSIONS

- 110 Vdc / 24 Vdc 10 A
- 110 Vdc / 24 Vdc 10 A redundant

Cod. XCSA240FC	
—	CSA240FC

## INPUT TECHNICAL DATA

- Input rated voltage
- Current @ Iout max.
- Inrush peak current
- Standby power
- Internal protection fuse
- External protection on AC line
- Overvoltage input protection circuit

110 Vdc (range 100...130 Vdc)	2.4 A ±10%
< 150A / < 2ms (1)	<3.4 W @ 110 Vdc
T 5 A replaceable	≥6 A C characteristic
Passive varistor and active shutdown at 136 Vdc	

## OUTPUT TECHNICAL DATA

- Output rated voltage
- Output adjustable range
- Continuous current
- Overload limit
- Short circuit peak current
- Load regulation
- Ripple @ nominal ratings
- Hold up time @ In (Uin 110 Vdc)
- Overload / short circuit protections
- Status display
- Alarm contact threshold
- Parallel connection
- Redundant parallel connection

24 Vdc	22.7...27 Vdc
10 A @ 50°C (2)	15 A
21 A for 300 ms	<1.5%
<100 mVpp	>4 ms
hiccup at the overload limit with auto reset / over temperature protection	"DC OK" green LED / "DC OK" alarm contact / "Overload" red LED
—	possible
factory provided with internal ORing diode	

## GENERAL TECHNICAL DATA

- Efficiency (Uin 110 Vdc)
- Dissipated power (Uin 110 Vdc)
- Operating temperature range
- Input/output isolation
- Input/ground isolation
- Output/ground isolation
- Standard/approvals
- EMC Standards
- MTBF @ 25°C @ nominal ratings
- Overvoltage category/Pollution degree
- Protection degree
- Connection terminal
- Housing material
- Approx. weight
- Mounting information

>89%	<28 W
-20...+60°C, with derating over 50°C (2)	2.1 kVdc / 60s (3)
	1.41 kVdc / 60s (3)
	0.75 kVdc / 60s (3)
IEC950, EN60950	EN61000-6-2, EN61000-6-4, EN61000-4-2, EN61000-4-3, EN61000-4-4, EN61000-5-5, EN61000-4-6, EN61000-4-11
	>500'000 h acc. to SN 29500 / >150'000 h acc. to MIL Std. HDBK 217F
II / 2	IP 20 IEC 529, EN60529
	2.5 mm² pluggable screw type
	aluminium
	800 g (28.24 oz)
	vertical on rail, allow 10 mm spacing between adjacent components

## MOUNTING ACCESSORIES

- Mounting rail type according to IEC60715/TH35-7.5
- Mounting rail type according to IEC60715/G32

PR/3/AC, PR/3/AC/ZB, PR/3/AS, PR/3/AS/ZB	—
--	---



# Adjustable linear power supply input 24 Vac

- Adjustable output voltage 1.2...24 Vdc
- Output current 1.5 and 5 A
- Short circuit, overload, over temperature protection

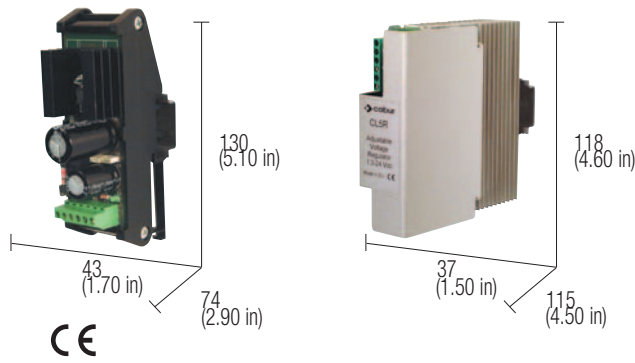

## NOTES

The depth dimension includes the terminal blocks and the DIN clamp.

(1) See "Applications"

## BLOCK DIAGRAM

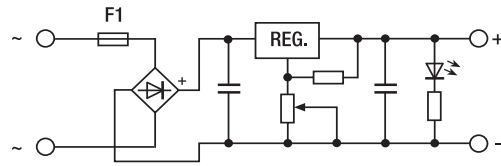

## VERSIONS

Output 1.2 A  
Output 5 A

### INPUT TECHNICAL DATA

Input rated voltage  
Frequency  
Current @ Iout max.  
Internal protection fuse  
External protection on AC line

### OUTPUT TECHNICAL DATA

Output rated voltage  
Output adjustable range  
Continuous current  
Overload limit  
Load regulation  
Ripple @ nominal ratings  
Hold up time @ In  
Overload / short circuit protections  
Status display

### GENERAL TECHNICAL DATA

Operating temperature range  
Input/output isolation  
Input/ground isolation  
Output/ground isolation  
Reference Standards  
EMC Standards  
MTBF @ 25°C @ nominal ratings  
Overvoltage category/Pollution degree  
Protection degree  
Connection terminal  
Housing material  
Approx. weight  
Mounting information

## Cod. XCL1R

CL1R

## Cod. XCL5R

CL5R

9...26 Vac (see Tab. 1)  
50...60 Hz

2,5 A  
T 3 A replaceable  
MCB: 4 A C characteristic - fuse T 4 A

6 A  
T 10 A replaceable  
MCB: 10 A C characteristic - fusibile T 10 A

1.2...24 Vdc

(see Tab. 1 and Tab. 2)  
0.3...1.5 A (see Tab. 2)

1.2...24 Vdc

(see Tab. 1 and Tab. 2)  
0.8...5 A (see Tab. 2)

< 1%  
< 50 mVpp @ 24 Vac  
>20 ms  
constant current, limit current, auto reset / over temperature protection  
"DC OK" green LED

-20...+45°C / over temperature protection (1)

not insulated  
0.5 kVac / 60 s  
0.5 kVac / 60 s

IEC 664-1, DIN VDE  
EN50081-1, EN61000-6-4  
>500'000 h acc. to SN 29500 / >150'000 h acc. to MIL Std. HDBK 217F  
II / 2  
IP 00 IEC 529, EN60529  
2.5 mm<sup>2</sup> fixed screw type

UL94V-0 plastic material  
120 g (4.23 oz)  
vertical on rail, allow 20 mm spacing between adjacent components

## APPLICATIONS

The CL-R linear regulated power supply series of CABUR is provided with adjustable output and it can satisfy all those needs related to the feeding of small loads with non-standard rated voltage and at an extremely limited cost. It can be mounted on the rail in whatever position, providing that enough space for the free circulation of the air remains for the cooling; the CL1R model having an IP 00 protection degree, its use is intended inside a protected enclosure. Even if the power supply is protected from over-current it is advisable to respect the rated values shown in table 1 and 2.

(1) CL1R and CL5R give the rated performances if fed by a voltage between 24 and 27 Vac, as indicated on Tab. 1; with input voltage between 24 and 27 Vac, the maximum output current for output voltages lower than 24 Vdc are indicated on Tab. 2; to achieve a good voltage stabilization and low ripple, linear power supplies must be fed with an input voltage higher than output voltage, while if they are supplied with 24 Vac, and adjusted for 24 Vdc output, when rated current is supplied, the ripple increases and voltage stabilization decreases; input voltages higher than 27 Vac increases power dissipation and increases operating temperature of the component, and might cause thermal protection shut down. The products are preadjusted to Vout 24 Vdc with Vin 26 Vac.

## MOUNTING ACCESSORIES

Mounting rail type according to IEC60715/TH35-7.5  
Mounting rail type according to IEC60715/G32

PR/3/AC, PR/3/AC/ZB, PR/3/AS, PR/3/AS/ZB

PR/DIN/AC, PR/DIN/AS, PR/DIN/AL

INPUT (Vac)	Uout max. (Vdc)	Iout max (A) XCL1R	Iout max (A) XCL5R
24...27	24	1.5	5
16...18	15	1.5	5
14...16	12	1.5	5
12...14	10	1.5	5
12	9	1.5	5
9	5	1.5	5

Tab. 1 (see explanation on right side)

INPUT (Vac)	Uout max. (Vdc)	Iout max (A) XCL1R	Iout max (A) XCL5R
24	24	1.5	5
24	15	0.8	2.5
24	12	0.7	2
24	10	0.5	1.5
24	9	0.45	1.3
24	5	0.3	0.8

Tab. 2 (see explanation on right side)

# Filtered power supplies without transformer with non regulated output

- DIN rail mounting
- Suitable for rectifying 6 Vac to 20 Vac
- V output = Vac input x 1.41 (-1V)

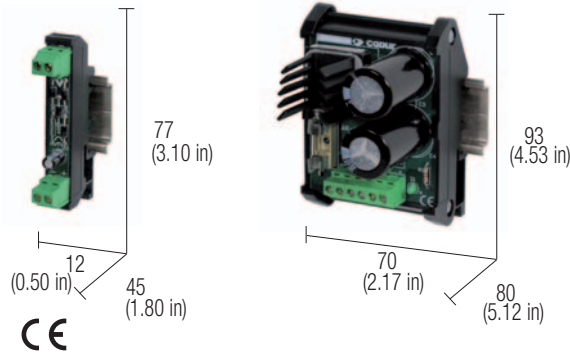

## NOTES

- (2) Version available upon request; for information call our sales department, local agent or representative  
 (3) They can work with input from min. 6 Vac to 30 Vac max., the non regulated output voltage depends on the load and on the variations of the input voltage supplied by the transformer  
 (4) They are protected from overcurrent by their input fuse (except AR1 model); it is recommended to protect cables of the output line with fuses of value coordinated with the current of the load and cables.

## BLOCK DIAGRAM

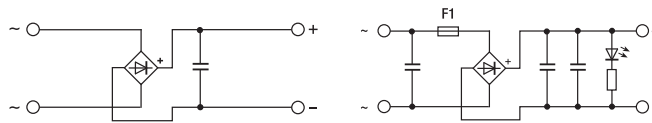

## VERSIONS

Output 1 A  
Output 6 A

### INPUT TECHNICAL DATA

Input rated voltage	6...20 Vac	
Frequency	50...60 Hz	
Current @ Iout max.	1.2 A @ 20 Vac	7.2 A @ 20 Vac
Internal protection fuse	not available	T 8 A replaceable
External protection on AC line	MCB: 1 A C characteristic - fuse T 1 A	MCB: 10 A C characteristic - fusibile T 10 A

### OUTPUT TECHNICAL DATA

Output voltage (without load)	$U_{out} = (U_{in} \times 1.41)$ (3)	
Output voltage (full load)	$U_{out} = (U_{in} \times 1.41) - 2$ (3)	
Continuous current	1 A @ 20°C	6 A @ 20°C
Overload limit	1 A	9 A
Load regulation	—	
Ripple @ nominal ratings	≤ 10%	
Hold up time @ In	>20 ms	
Overload / short circuit protections	not available, insert external fuse (4)	
Status display	"DC OK" green LED	
Parallel connection	—	
Redundant parallel connection	—	

### GENERAL TECHNICAL DATA

Operating temperature range	-20...+45°C / max 60°C	
Input/output isolation	not insulated	
Input/ground isolation	0.5 kVac / 60 s	
Output/ground isolation	0.5 kVac / 60 s	
Reference Standards	IEC 664-1, DIN VDE	
MTBF @ 25°C @ nominal ratings	>500'000 h acc. to SN 29500 / >150'000 h acc. to MIL Std. HDBK 217F	
Overvoltage category/Pollution degree	II / 2	
Protection degree	IP 00 IEC 529, EN60529	
Connection terminal	2.5 mm² fixed screw type	
Housing material	UL94V-0 plastic material	
Approx. weight	22 g (0.77 oz)	140 g (4.93 oz)
Mounting information	vertical on rail, allow 50 mm spacing between adjacent components	

### MOUNTING ACCESSORIES

Mounting rail type according to IEC60715/TH35-7.5  
 Mounting rail type according to IEC60715/G32

Cod. XAR1	Cod. XAR2
AR1 (2)	AR6
6...20 Vac	
50...60 Hz	
1.2 A @ 20 Vac	7.2 A @ 20 Vac
not available	T 8 A replaceable
MCB: 1 A C characteristic - fuse T 1 A	MCB: 10 A C characteristic - fusibile T 10 A
$U_{out} = (U_{in} \times 1.41)$ (3)	
$U_{out} = (U_{in} \times 1.41) - 2$ (3)	
1 A @ 20°C	6 A @ 20°C
1 A	9 A
—	
≤ 10%	
>20 ms	
not available, insert external fuse (4)	
"DC OK" green LED	
—	
—	
-20...+45°C / max 60°C	
not insulated	
0.5 kVac / 60 s	
0.5 kVac / 60 s	
IEC 664-1, DIN VDE	
>500'000 h acc. to SN 29500 / >150'000 h acc. to MIL Std. HDBK 217F	
II / 2	
IP 00 IEC 529, EN60529	
2.5 mm² fixed screw type	
UL94V-0 plastic material	
22 g (0.77 oz)	140 g (4.93 oz)
vertical on rail, allow 50 mm spacing between adjacent components	
PR/3/AC, PR/3/AC/ZB, PR/3/AS, PR/3/AS/ZB	
PR/DIN/AC, PR/DIN/AS, PR/DIN/AL	

## APPLICATIONS

A rectified and filtered power supply is made with a rectifier bridge and a filter capacitor, that converts the alternating voltage into a continuous voltage. Since the power supply unit is not regulated, the output voltage varies considerably according to the current required by the load and according to the ±10% mains voltage variations. The formula indicated in the output specifications allows to calculate the output voltage with Zero load, with 50% load and full load. This allows you to choose the most suitable transformer for your needs. **These units offer a low cost and a reliable voltage source suitable for loads such as relays, contactors, solenoid valves or loads that can work with relatively high ripple and wide voltage variations; in applications where mains is unstable or troubled, it might be not suitable to feed microprocessor devices, analog converters, encoders and electronic devices which are sensitive to voltage variations.**

INPUT (Vac)	OUTPUT without load (Vdc)	OUTPUT full load (Vdc)
20	28.7	24.2
18	25.4	21.4
15	21.2	17.2
12	17	15
9	12.7	8.7
6	8.5	4.5

# Accessory for charging buffer batteries

- Battery charger
- Allows to connect in redundant parallel two power supplies
- Suitable for power supplies up to 10 A
- Battery protection fuse
- Battery feedback protection diode
- Current charge limiting resistor

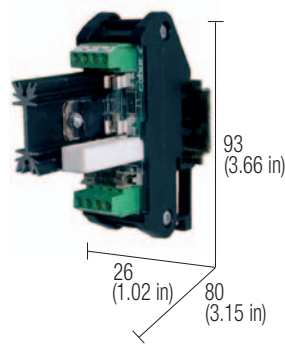

## NOTES

The depth dimension includes the terminal blocks and the DIN rail clamp.

- (1) The charging current is dependent on the battery type and the required level of charge, it's about:
- 0,5A max @ 12Vdc battery
  - 1A max @ 24Vdc battery
- (2) The device do not avoid total discharge which always shortens battery life.

## BLOCK DIAGRAM

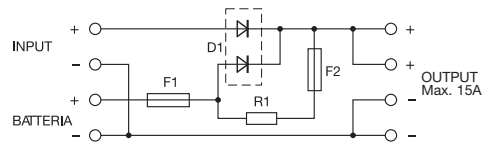

## VERSIONS

## Cod. XCSBC

## APPLICATIONS

### GENERAL TECHNICAL DATA

Power supply rated voltage	6...30 Vdc
Power supply rated current	> 3 A
Load rated voltage	6...29.5 Vdc
Load max current	10 A
Charge current limitation	(1)
Battery disconnecting voltage	not available
IN/OUT drop voltage	0.5 V
Battery protection fuse	F1 = T 6.3 A / F2 = T 1 A
Protections	battery short circuit /overload (2)
Alarm signal	—
Operating temperature range	-10...+50°C
Reference Standards	IEC 664-1, DIN VDE
Overvoltage category/Pollution degree	II / 2
Protection degree	IP 20 IEC 529, EN60529
Connection terminal	2.5 mm <sup>2</sup> fixed screw type
Housing material	UL94V-0 plastic material
Approx. weight	80 g (2.82 oz)
Mounting information	vertical on rail, adjacent

### 1. Battery charger

With this module is possible to use a Cabur power supply as a battery charger while it is feeding the load.

The diode provides decoupling between the battery and the power supply; the resistance limits the current charge limiting power supply output current and assuring longer life to the battery. The F1 fuse protects the battery and its wiring against short circuit.

The next picture shows the connections.

### 2. Parallel connection of power supplies

It is possible to use this module also to connect two power supplies in parallel, not provided with output decoupling diode, eliminating "Fuse 2" in series to charging current limiting resistor.

The next picture shows the connections.

### 1. Battery charger

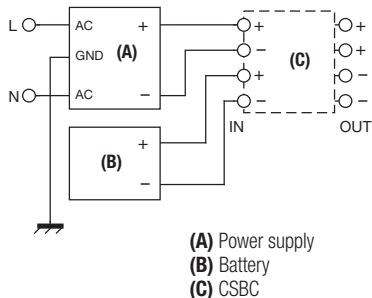

### 2. Parallel connection of power supplies

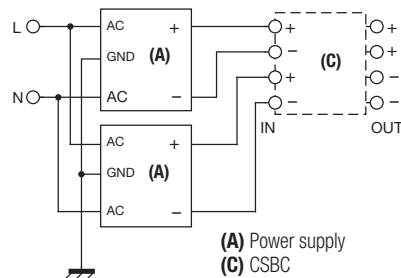

# Accessory for charging and controlling buffer batteries

- Suitable for power supply with adjustable output
- Suitable for lead batteries
- Suitable for charging batteries while feeding loads
- Battery protection fuse
- "Deep discharge" battery protection
- Status display LED and failure contact

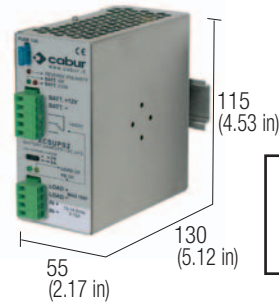

Items sold until sell-out, will be replaced by **XCSU240S** from April 2014



## NOTES

The depth dimension includes the DIN rail clamp.

## BLOCK DIAGRAM

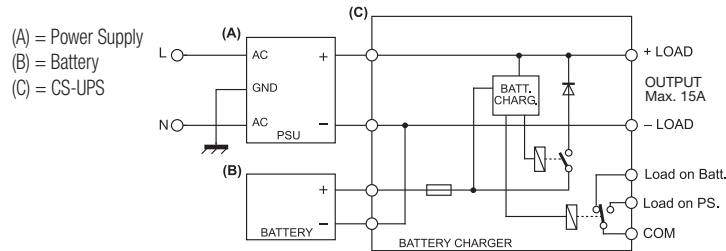

## VERSIONS

Output 24 Vdc  
Output 12 Vdc

## GENERAL TECHNICAL DATA

Power supply input voltage
Power supply rated current
Load rated voltage
Max load current
Charging current
Battery disconnection voltage
IN/OUT voltage drop
Battery protection fuse
Protections
Alarm signals
Operating temperature range
EMC Standards
Overvoltage category/Pollution degree
Protection degree
Connection terminal
Housing material
Approx. weight
Mounting information

## Cod. XCSUPS1 Cod. XCSUPS2

CS-UPS1 CS-UPS2

26...28.5 Vdc	12...15 Vdc
≥ 3 A	≥ 3 A
<b>26...28 Vdc</b>	<b>10...15 Vdc</b>
<b>10 A</b>	<b>10 A</b>
selectable 2 A or 4 A	selectable 2 A or 4 A
≤ 18 Vdc ±0.5V	≤ 9.2 Vdc ±0.5V
0.4 V	
T 15 A 42 V blade type	
Reverse polarity, short circuit, battery overload, battery deep discharge	
SPDT 24 V / 1 A	
green LED	
red LED	
yellow LED	
green LED	
-10...+50°C	
IEC 664-1, DIN VDE	
II / 2	
IP 20 IEC 529, EN60529	
2.5 mm <sup>2</sup> pluggable screw type	
aluminium	
300 g (10.58 oz)	
vertical on rail, adjacent	

## APPLICATIONS

All power supplies with adjustable output voltage to +15% of rated voltage can be used as lead battery chargers, suitable to be used as back up supply in case of AC line breakdown.

The CS-UPS-1 circuit regulate the current charging the battery, and it is possible to set it up to 2A or 4A charging current ; CS- UPS1 disconnects the load from the battery whenever the battery voltage drops under 19Vdc, to avoid total discharge which always shortens battery life.

The module is provided with a fuse protecting the battery and its cable to prevent fire risk in case of short circuit. The module is provided with the following leds display:

**PS OK:** The green LED is on when the power supply feeding the CS-UPS1 is OK and the load is supplied by the power supply while the battery is continuously charged.

**LOAD OK:** Yellow LED is on when CS-UPS1 feeds the load.

**BATT. OK:** Green LED is on when the power supply is turned OFF or disconnected and indicates that the battery is connected and can feed the load.

**BATT. LOW:** Red LED on when the battery is low or discharged.

**REVERSE BATTERY:** Red LED is on when battery is connected with reverse polarity.

**Alarm contact:** a relay with an SPDT contact 1A/24V switches when the load is no more supplied by the power supply and then is supplied by the battery. This contact allows to get a remote warning on the status of the system even in the case that the power supply is turned OFF or damaged, or non more supplied for any reasons.

## MOUNTING ACCESSORIES

Mounting rail type according to IEC60715/TH35-7.5  
Mounting rail type according to IEC60715/G32

**PR/3/AC, PR/3/AC/ZB, PR/3/AS, PR/3/AS/ZB**

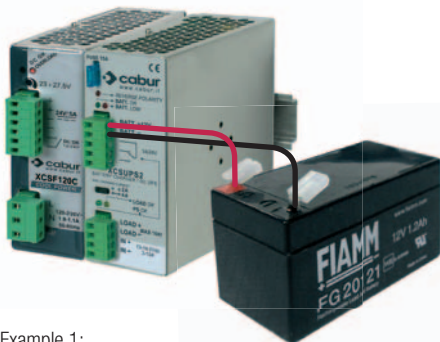

Example 1:  
XCSF120C + XCSUPS1 + batteria



Example 2:  
XCSF120C + XCSUPS1 + XCSBP30Y

# Accessory for charging and controlling buffer batteries



- Suitable for lead and NiMH batteries
- Suitable for 12 or 24V battery with current load up to 3 A
- High efficiency and low dissipated power
- Compact dimensions
- Connected to a power supply, provides power to the load and keeps the battery in buffer

Available from March 2014

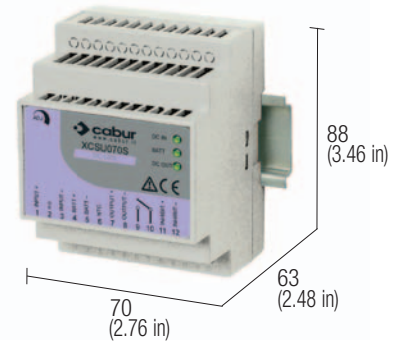

## NOTES

The depth dimension includes the DIN rail clamp.

(1) Product under development and available from March 2014, the technical data and the image are to be considered preliminary and subject to change.

## BLOCK DIAGRAM

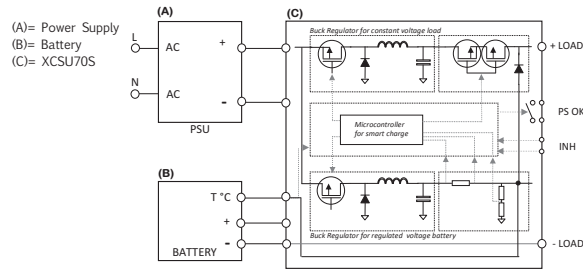

## VERSIONS

Cod. XCSU070S

CSU070S (1)

## APPLICATIONS

### INPUT TECHNICAL DATA

Input voltage	<b>12-24 Vdc</b> (range 10...16 Vdc / 20...29 Vdc)
Maximum input current	3 A
Consumption without load	n.d.

### OUTPUT TECHNICAL DATA

Load rated voltage	<b>12-24 Vdc</b>
Current of the load	3 A (max. 4.5 A for 5 s)
Status display	"Backup" alarm contact "DC OK" green LED "Alarm/Failure" red LED 0

### BATTERY TECHNICAL DATA

Battery type	Lead-Acid, NiMH
Nominal battery voltage	12 or 24 Vdc
Maximum charge current	0.5 A
Backup delay	n.d.
Protections	Reverse polarity, short circuit, battery overload, battery deep discharge

### GENERAL TECHNICAL DATA

Efficiency	>90%
Dissipated power	—
Operating temperature range	-20...+60°C
Input / output isolation	0.5 kVac / 60 s
Input / ground isolation	0.5 kVac / 60 s
Output / ground isolation	0.5 kVac / 60 s
Standard/approvals	EN60950
EMC Standards	EN61000-6-2, EN61000-6-4
MTBF @ 25°C @ nominal ratings	>500'000 h acc. to SN 29500 / >150'000 h acc. to MIL Std. HDBK 217F
Overtoltage category/Pollution degree	II / 2
Protection degree	IP 20 IEC 529, EN60529
Connection terminal	2.5 mm <sup>2</sup> fixed screw type
Housing material	UL94V-0 plastic material
Approx. weight	250 g
Mounting information	vertical on rail, allow 10 mm spacing between adjacent components

### MOUNTING ACCESSORIES

Mounting rail type according to IEC60715/TH35-7.5	<b>PR/3/AC, PR/3/AC/ZB, PR/3/AS, PR/3/AS/ZB</b>
Mounting rail type according to IEC60715/G32	—



# Accessory for charging and controlling buffer batteries



- Suitable for lead and NiMH batteries
- Suitable for 12 or 24V battery battery with current load up to 10 A
- High efficiency and low dissipated power
- Compact dimensions
- Connected to a power supply, provides power to the load and keeps the battery in buffer

Available from April 2014



## NOTES

The depth dimension includes the DIN rail clamp.

(1) Product under development and available from March 2014, the technical data and the image are to be considered preliminary and subject to change.

## BLOCK DIAGRAM

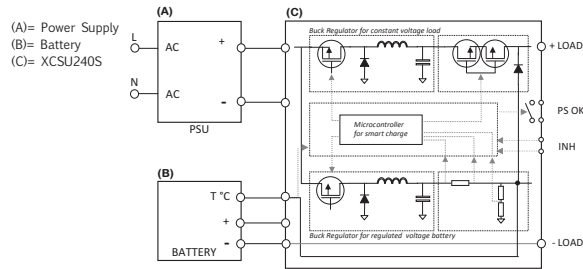

## VERSIONS

Cod. XCSU240S

CSU240S (1)

## APPLICATIONS

### INPUT TECHNICAL DATA

Input voltage

**12-24 Vdc** (range 10...16 Vdc / 20...29 Vdc)

Maximum input current

10 A

Consumption without load

n.d.

### OUTPUT TECHNICAL DATA

Load rated voltage

**12-24 Vdc**

Current of the load

10 A (max. 15 A for 5 s)

Status display

Alarm contact: normal operation (Ready)

Alarm contact: battery operation (Backup)

"DC OK" green LED

LED red alarm or backup failure

### BATTERY TECHNICAL DATA

Battery type

Lead-Acid, NiMH

Nominal battery voltage

12 or 24 Vdc

Maximum charge current

2 A

Backup delay

n.d.

Protections

Reverse polarity, short circuit, battery overload, battery deep discharge

### GENERAL TECHNICAL DATA

Efficiency

>90%

Dissipated power

—

Operating temperature range

-20...+60°C

Input / output isolation

0.5 kVac / 60 s

Input / ground isolation

0.5 kVac / 60 s

Output / ground isolation

0.5 kVac / 60 s

Standard/approvals

EN60950

EMC Standards

EN61000-6-2, EN61000-6-4

MTBF @ 25°C @ nominal ratings

>500'000 h acc. to SN 29500 / >150'000 h acc. to MIL Std. HDBK 217F

Overtoltage category/Pollution degree

II / 2

Protection degree

IP 20 IEC 529, EN60529

Connection terminal

4 mm<sup>2</sup> pluggable screw type (IN/OUT/BATT) e 0,75 mm<sup>2</sup> (signal)

Housing material

aluminium

Approx. weight

500 g

Mounting information

vertical on rail, allow 10 mm spacing between adjacent components

### MOUNTING ACCESSORIES

Mounting rail type according to IEC60715/TH35-7.5

PR/3/AC, PR/3/AC/ZB, PR/3/AS, PR/3/AS/ZB

Mounting rail type according to IEC60715/G32

—

# Accessory for charging and controlling buffer batteries



- Suitable for lead and NiMH batteries
- Suitable for 12 or 24V battery with currents load up to 20 A
- High efficiency and low dissipated power
- Compact dimensions
- Connected to a power supply, provides power to the load and keeps the battery in buffer

Under development and available from May 2014



## NOTES

The depth dimension includes the DIN rail clamp.

(1) Product under development and available from April 2014, the technical data and the image are to be considered preliminary and subject to change.

## BLOCK DIAGRAM

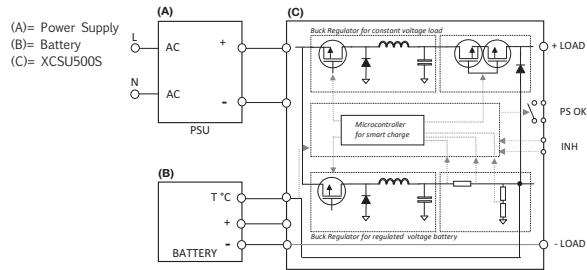

## VERSIONS

Cod. XCSU500S

CSU500S (1)

## APPLICATIONS

### INPUT TECHNICAL DATA

Input voltage

**12-24 Vdc** (range 10...16 Vdc / 20...29 Vdc)

Maximum input current

20 A

Consumption without load

<2 W

### OUTPUT TECHNICAL DATA

Load rated voltage

**12-24 Vdc**

Current of the load

20 A (max. 30 A for 5 s)

Status display

Alarm contact: normal operation (Ready)

Alarm contact: battery operation (Backup)

"DC OK" green LED

Red LED for backup or failure alarm

### BATTERY TECHNICAL DATA

Battery type

Lead-Acid, NiMH

Nominal battery voltage

12 or 24 Vdc

Maximum charge current

5 A

Backup delay

n.d.

Protections

Reverse polarity, short circuit, battery overload, battery deep discharge

### GENERAL TECHNICAL DATA

Efficiency

>90%

Dissipated power

—

Operating temperature range

-20...+60°C

Input / output isolation

0.5 kVac / 60 s

Input / ground isolation

0.5 kVac / 60 s

Output / ground isolation

0.5 kVac / 60 s

Standard/approvals

EN60950

EMC Standards

EN61000-6-2, EN61000-6-4

MTBF @ 25°C @ nominal ratings

>500'000 h acc. to SN 29500 / >150'000 h acc. to MIL Std. HDBK 217F

Overtoltage category/Pollution degree

II / 2

Protection degree

IP 20 IEC 529, EN60529

Connection terminal

4 mm<sup>2</sup> pluggable screw type (IN/OUT/BATT) e 0,75 mm<sup>2</sup> (signal)

Housing material

aluminium

Approx. weight

500 g

Mounting information

vertical on rail, allow 10 mm spacing between adjacent components

### MOUNTING ACCESSORIES

Mounting rail type according to IEC60715/TH35-7.5

PR/3/AC, PR/3/AC/ZB, PR/3/AS, PR/3/AS/ZB

Mounting rail type according to IEC60715/G32

# Batteries holder module

- 12 or 24 Vdc selectable output voltage
- Suitable for sealed lead rechargeable batteries
- Suitable for CSBC, CS-UPS, CSC75
- Suitable for DIN rail installation

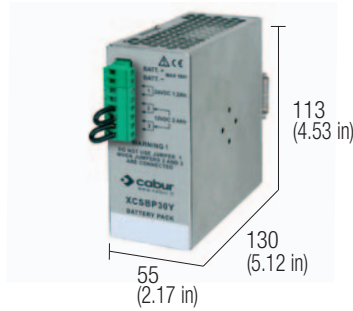

## NOTES

The depth dimension includes the terminal blocks and the DIN rail clamp.

(1) Into XCSBP30Y are necessary two batteries 8911012

## BLOCK DIAGRAM

SERIES connection: jumper 1  
PARALLEL connection: jumper 2 + 3

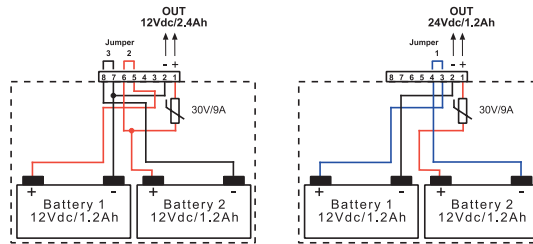

## VERSIONS

Batteries holder module (empty)  
Battery (1)

CSBP30Y  
BAT12V1,2AH

Cod. XCSBP30Y  
Cod. 8911012

## GENERAL TECHNICAL DATA

Batteries type	2 sealed batteries 12 Vdc 1.2 Ah	
Internal protection fuse	15 A	
Setup type	<b>parallel</b>	<b>series</b>
Output voltage	12 Vdc 2.4 Ah	24 Vdc 1.2 Ah
Charging current max.	0.6 A	0.3 A
Discharging current max.	5 A	3 A
Operating temperature range	-10...+50°C	
EMC Standards	IEC 664-1, DIN VDE	
Overvoltage category/Pollution degree	II / 2	
Protection degree	IP 20 IEC 529, EN60529	
Connection terminal	2.5 mm <sup>2</sup> pluggable screw type	
Housing material	aluminium	
Approx. weight	1.2 kg (42,36 oz)	
Mounting information	vertical on rail, adjacent	

## APPLICATIONS

## MOUNTING ACCESSORIES

Mounting rail type according to IEC60715/TH35-7.5  
Mounting rail type according to IEC60715/G32

PR/3/AC, PR/3/AG/ZB, PR/3/AS, PR/3/AS/ZB



Example 1:  
XCS120C + XCSBP30Y

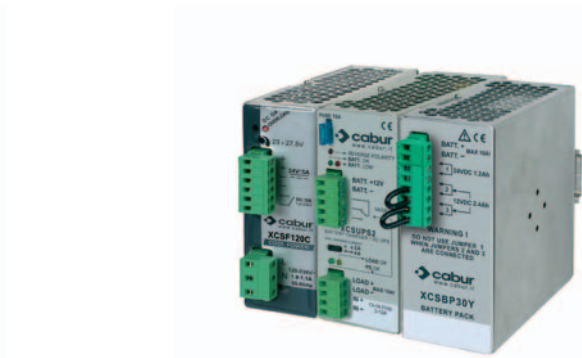

Example 2:  
XCSUPS1 + XCSBP30Y

# Switching power supply with integrated battery charger

- Suitable for 12 Vdc loads and batteries
- Suitable for lead batteries
- Suitable for charging batteries while feeding loads
- Battery protection circuit
- "Deep discharge" battery protection
- Status display LED and failure contact

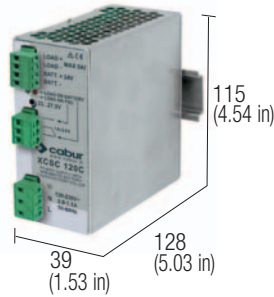

## NOTES

- The depth dimension includes the terminal blocks and the DIN clamp.
- (2) With 100...127 Vdc input voltage, constant output power and  $T_a > 45^\circ\text{C}$ , the output current must be derated by 25%
- (3) In addition to the current load, the device supplies about 0.8 A for battery charging
- (4) Over  $50^\circ\text{C}$  ( $122^\circ\text{F}$ ) apply a derating  $-0.13\text{ A}/^\circ\text{C}$ , max  $60^\circ\text{C}$

## BLOCK DIAGRAM

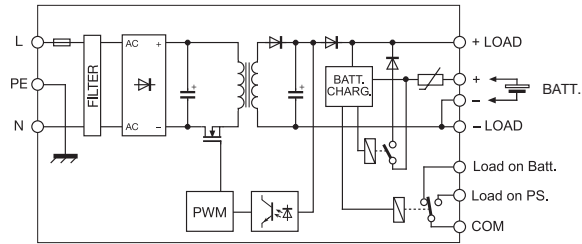

## VERSIONS

- Output 12 Vdc 5 A
- Output 24 Vdc 5 A

## Cod. XCSC120B

CSC120B

## Cod. XCSC120C

CSC120C

## APPLICATIONS

## INPUT TECHNICAL DATA

- Input rated voltage
- Frequency
- Current @ nominal lout (U<sub>in</sub> 120 / 230 Vac)
- Inrush peak current
- Power factor
- Internal protection fuse
- External protection on AC line

**120–230 Vac** (range 90...264 Vac / 100...370 Vdc) (2)

47...63 Hz

2.0 A / 1.1 A  $\pm$  10%

< 20 A

> 0.6

T 3.15 A replaceable

circuit breaker: 4 A - C characteristic - fuse: T 3.15 A

## OUTPUT TECHNICAL DATA

- Output voltage with operating power supply
- Output voltage with batteries
- Continuous current
- Overload limit
- Short circuit peak current
- Load regulation
- Ripple @ nominal ratings
- Hold up time @ I<sub>n</sub> (U<sub>in</sub> 120 / 230 Vac)
- Overload / short circuit protections

**12.5...15.5 Vdc**

**23...27.5 Vdc**

- 12...14.4 Vdc
- 7 A @ 50°C** (3)
- >11 A for >30 s
- >18 A for >50 ms
- < 1%
- 80 mVpp
- >24 ms / >80 ms

- 24...26.2 Vdc
- 5 A @ 50°C** (3)
- >8 A for >30 s
- >12 A for >50 ms
- < 1%
- 80 mVpp
- >17 ms / >72 ms

with operating power supply: hiccup at the overload limit with auto reset  
 non operating power supply: auto resettable electronic fuse against battery short circuit  
 with non operating power supply: threshold-relay against battery deep discharge  
 "PSU OK" green LED / failure contact / "BATTERY" red LED  
 0.8 A (suitable for sealed lead batteries up to 15 Ah)

- Alarm signals
- Max. charging current

## GENERAL TECHNICAL DATA

- Efficiency (U<sub>in</sub> 120 / 230 Vac)
- Dissipated power (U<sub>in</sub> 120 / 230 Vac)
- Operating temperature range
- Input/output isolation
- Input/ground isolation
- Output/ground isolation
- Standard/approvals
- EMC Standards
- MTBF @ 25°C @ nominal ratings
- Overvoltage category/Pollution degree
- Protection degree
- Connection terminal
- Housing material
- Approx. weight
- Mounting information

>86% / >90%

21 W / 13 W

-20...+60°C, with derating over 50°C / over temperature protection (4)

1.5 kVac / 60 s SELV output

1.5 kVac / 60 s

0.5 kVac / 60 s

IEC950, EN60950

EN55011, EN61000-6-1

>500'000 h acc. to SN 29500 / >150'000 h acc. to MIL Std. HDBK 217F

II / 2

IP 20 IEC 529 EN60529

2.5 mm<sup>2</sup> pluggable screw type

aluminium

500 g (17.65 oz)

vertical on rail, allow 10 mm spacing between adjacent components

## MOUNTING ACCESSORIES

- Mounting rail type according to IEC60715/TH35-7.5
- Mounting rail type according to IEC60715/G32

PR/3/AC, PR/3/AC/ZB, PR/3/AS, PR/3/AS/ZB



# Accessory for power supplies redundant parallel connections

- Suitable for power supplies without Oring diodes
- Compact dimensions
- Three selectable voltages 12, 24 and 48 Vdc
- 2 status/relays contacts
- Power supplied status LED

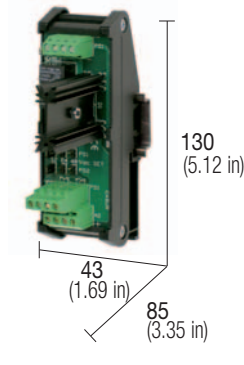

## NOTES

The depth dimension includes the terminal blocks and the DIN rail clamp.

## BLOCK DIAGRAM

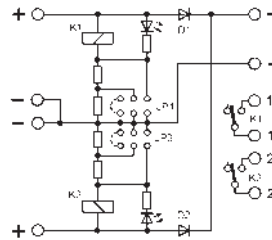

## VERSIONS

## Cod. XCSBD

CSBD

## APPLICATIONS

This module allows the customer to connect in redundant parallel two power supplies not provided with built in Oring diodes (output decoupling diodes); a jumper bridge allows to select 12, 15, 24 or 48 Vdc operating voltage; each channel is provided with status indication led, status relay and contact for remote failure alarm.

## GENERAL TECHNICAL DATA

Power supply rated voltage	<b>12–24–48 Vdc</b> selectable
Power supply rated current	15 A, max 30 A
Load rated voltage	<b>12–24–48 Vdc</b> selectable
Load max current	15 A
IN/OUT drop voltage	0.7 V @ 15 A
Protections	—
Alarm signal	2 contacts NA 2A @ 230 Vac
Operating temperature range	–20...+50°C
Reference Standards	IEC 664-1, DIN VDE
Overvoltage category/Pollution degree	II / 2
Protection degree	IP 00 IEC 529, EN60529
Connection terminal	2.5 mm <sup>2</sup> fixed screw type
Housing material	UL94V-0 plastic material
Approx. weight	120 g (4.23 oz)
Mounting information	vertical on rail, adjacent

## MOUNTING ACCESSORIES

Mounting rail type according to IEC60715/TH35-7.5  
Mounting rail type according to IEC60715/G32

**PR/3/AC, PR/3/AC/ZB, PR/3/AS, PR/3/AS/ZB**  
**PR/DIN/AC, PR/DIN/AS, PR/DIN/AL**

## Block diagram

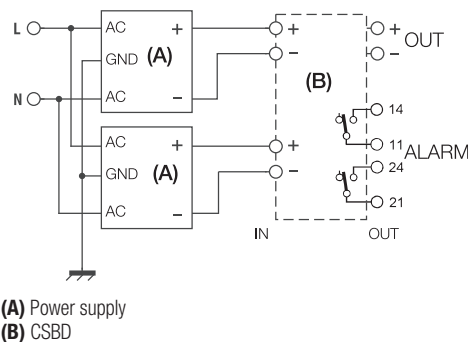

# Accessory for power supplies redundant parallel connections



- Suitable for connection of power supplies without ORing diodes
- Load voltages from 12 to 85 V with currents of up to 50 A
- Electronic redundancy controlled by CPU
- Failure alarm and unbalanced current alarm
- High efficiency and low dissipated power
- Compact dimensions

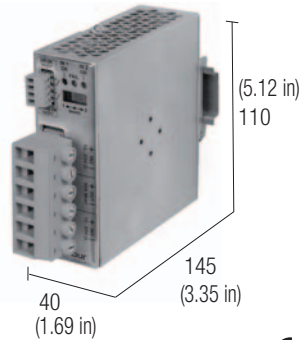

UL pending



## NOTES

The depth dimension includes the terminal blocks and the DIN rail clamp.

## BLOCK DIAGRAM

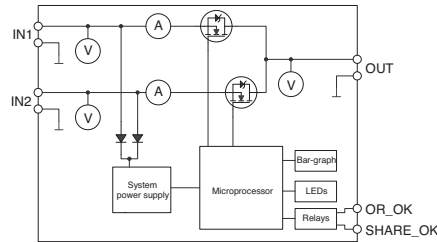

## VERSIONS

Cod. XCSR50U

CSR50U

## APPLICATIONS

## GENERAL TECHNICAL DATA

Input voltage  
Maximum input current  
Load rated voltage  
Load maximum current  
IN/OUT voltage drop  
Protections  
Status display

**12...85 Vdc**  
50 A  
**10,8...85 Vdc**  
**50 A** (max. 300 A picco)  
0,2 V @ 50 A  
reverse polarity, input overvoltage  
green LED for input voltage control  
red LED alarm for redundancy alarm  
alarm contact for redundancy alarm (24V/1A)  
LED bar for the control of the unbalance current  
alarm contact for the control of the unbalance current

The CSR50U is an advanced, microprocessor-controlled module used for redundant parallel connections of two DC power supplies in applications needing higher reliability than provided by common passive ORing modules with diodes to isolate the outputs of the two power supplies.

The CSR50U comes with a current measurement sensor on each input to detect the correct supplied by the two power supplies and signal an alarm when the current supplied is unbalanced. An imbalance greater than 60% in the supply current is a certain indicator that one of the power supplies is failing. Detecting this situation and signalling an alarm with an SPST contact allows preventative maintenance to take place and increases the system's reliability. In redundant systems where an imbalance in the supply is not controlled, it is not possible to monitor the correct supply of current from the two power sources. This setup permits a situation in which the current is supplied by only one power source, which then is forced to work under greater stress. Furthermore, the power source which supplies less current (or no current) may not trigger an alarm in certain conditions.

The CSR50U allows two identical power supplies to be connected for a total current output of 50 A and overall voltage from 12 to 85 Vdc.

Thanks to the ORing and isolation between the two power supplies with the microprocessor-controlled MOSFET, the power dissipated is one tenth that of redundant modules with diodes. In addition, CSR50Us can be connected together to obtain redundancy of more than two systems.

The CSR50U provides status signals on:

- a fault or power loss in one of the two power sources
- unbalanced current supplies greater than 60%

Efficiency  
Dissipated power  
Operating temperature range  
Input/output isolation  
Input/ground isolation  
Output/ground isolation  
Standard/approvals  
EMC Standards  
MTBF @ 25°C @ nominal ratings  
Overvoltage category/Pollution degree  
Protection degree  
Connection terminal  
Housing material  
Approx. weight  
Mounting information

>98% (12 V / 50A)  
10 W  
-20...+50°C  
0.5 kVac / 60 s  
0.5 kVac / 60 s  
EN 60950  
EN 61000-6-2, EN 61000-6-4  
>500'000 h acc. to SN 29500 / >150'000 h acc. to MIL Std. HDBK 217F II / 2  
IP 20 IEC 529, EN60529  
removable screw terminals 16 mm<sup>2</sup> (IN / OUT) and 1.5 mm<sup>2</sup> (signal)  
aluminium  
200 g  
vertical on rail, allow 10 mm spacing between adjacent components

## MOUNTING ACCESSORIES

Mounting rail type according to IEC60715/TH35-7.5  
Mounting rail type according to IEC60715/G32

**PR/3/AC, PR/3/AC/ZB, PR/3/AS, PR/3/AS/ZB**

# MBC2K

## Motor brake controller

The **MBC2K** is a device controlled by a microprocessor, that can automatically insert a power resistor into the DC BUS for braking a motor fed by the same DC Bus through a motor drive. The function of the MBC2K is to dissipate the energy delivered by the motor in an external resistor thus damping the resulting overvoltage on the DC Bus.

On top of that the MBC2K provides several protections to ensure reliable operation.

MBC2K can be connected to any DC Bus within 24Vdc and 100Vdc. The simplified application diagram is shown in Figure 1, while the unit front view with all its controls is shown in Figure 2.

Up to 4 MBC2K units can be connected in parallel to increase the braking power up to 8kW max. The MBC2K is provided with a 2.5 digits 7 segments LED display, used to display the DC Bus voltage (with +/- 1V accuracy), to help the user during the setup phase and/or to show error messages.

### MBC2K Setup

The MBC2K unit needs to be set up before operating.

The setup phase consists of 3 menu pages. The user can navigate through the menu pages by pressing the MENU button and the values on each menu page can be changed by pressing SET / RESET button.

The three menu pages are the following:

- Brake intervention threshold (VTH) setup
- Hysteresis around the brake intervention threshold voltage
- Master / Slave mode, used for parallel connection up to four modules.

### MBC2K protection and error codes

The MBC2K unit integrates several active protections to guarantee reliable operations in normal conditions. As soon as a faulty event is detected the MBC2K power stage is switched off so that no uncontrolled current flow through the brake resistor is possible. A fault condition is indicated by the continuous blinking of the Alarm LED. Remote sensing of the status of the MBC2K unit is possible thanks to the Alarm relay dry contact. To help the user to understand which faulty event occurred, an error code is displayed on the 7 segments LED display. Every protection is latched, so that to put back the MBC2K unit in "operation mode".

### Parallel connection up to 4 MBC2K units

The MBC2K brake controller provides a feature allowing connecting up to 4 identical MBC2K units to **increase the peak braking power up to 8kW**. In any case every MBC2K unit can handle only 2kW of peak braking power therefore every MBC2K unit need its own 2kW brake resistor.

To realize this feature the MBC2K is equipped with a Synchronization Bus used to synchronize the operation of all the units connected to the synchronization bus. The principle of operation relies on one MBC2K unit configured as the **master** and others MBC2K units (up to 3) configured as **slave**.

The master measures the DC Bus voltage and decides when to insert its brake resistor in the circuit; on top of that it sends a command on the synchronization bus.

The slaves connected on the synchronization bus are waiting for the command sent by the master; when they receive the command they insert their brake resistors in the circuit too. Please note that even when the MBC2K is configured in slave mode, all its circuits protections are functional.



Figure 1: Simplified application diagram

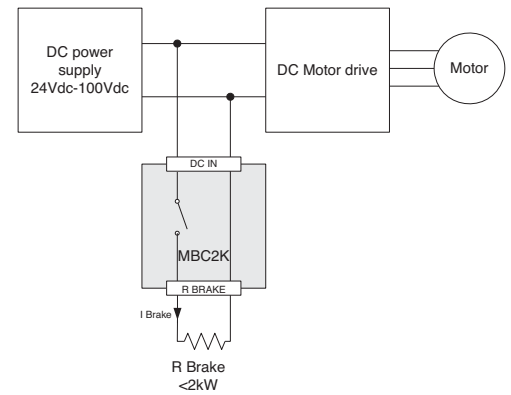

- SET/RESET button:** used to reset the protections and to change setup values in setup mode.
- MENU button:** used to enter into setup mode and to navigate through menu pages.
- Synchronization bus connector:** used to parallel up to 4 units.
- Resistor temperature sensor connector:** used to connect an optional brake resistor temperature sensor.
- Alarm dry contact connector:** an SPDT contact provide remote failure signal.
- Brake resistor connector:** used to connect the brake resistor wires 2.5mm<sup>2</sup>
- DC Bus connector:** used to connect the MBC2K unit to the power supply Bus (24...100Vdc).
- Protective earth (PE) connection:** to connect the module to the protective earth.
- LED display 100's indicator:** used to display numbers >99 on 2 digits; when this indicator is lit and the display shows "03" this means 103V.
- Brake indicator LED:** used to display braking activity; when lit it means that there is a current flow through the brake resistor.
- 2.5 digits 7-segment display:** in operating mode it shows the voltage measured on the DC Bus (accuracy +/- 1V); it's used also to show menu items and error codes.
- Alarm LED:** used to indicate a fault condition of the unit.

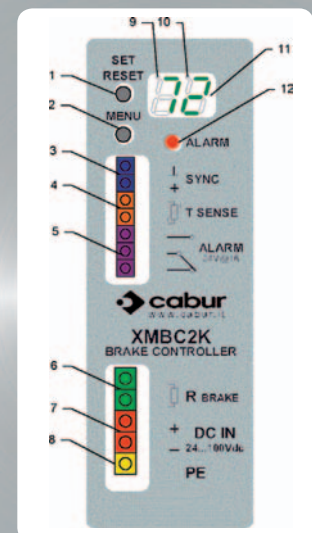
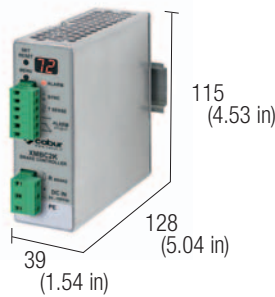

Figure 2: MBC2K Front View



# Motor brake controller

- 20 threshold levels with automatic activation
- Each module can drive 2kW braking power
- It is possible to connect up to four modules master/slave to get 8kW total braking power
- Simple functions programming and set up
- Control of the temperature of the braking resistor



## NOTES

The depth dimension includes the terminal blocks and the DIN clamp.

## BLOCK DIAGRAM

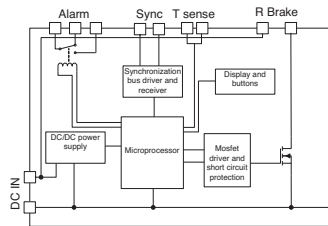

## VERSIONS

## Cod. XMBC2K MBC2K

## APPLICATIONS

The MBC2K is a device controlled by a microprocessor, that can automatically insert a power resistor into the DC BUS for braking a motor fed by the same DC Bus through a motor drive. The function of the MBC2K is to dissipate the energy delivered by the motor in an external resistor thus damping the resulting over-voltage on the DC Bus. On top of that the MBC2K provides several protections to ensure reliable operation. MBC2K can be connected to any DC Bus within 24Vdc and 100Vdc. The simplified application diagram is shown in Figure 1, while the unit front view with all its controls is shown in Figure 2. Up to 4 MBC2K units can be connected in parallel to increase the braking power up to 8kW max. The MBC2K is provided with a 2.5 digits 7 segments LED display, used to display the DC Bus voltage (with +/- 1V accuracy), to help the user during the setup phase and/or to show error messages.

## INPUT TECHNICAL DATA

Nominal DC BUS voltage range
Maximum braking current
Brake activation voltage
Brake voltage hysteresis
User interface

## 24...100 Vdc

50 A for 1 s

## 27...106 V, threshold adjustable in 20 steps

3 V o 6 V selectable

2 setup push buttons (SET/RESET and MENU)

2 x 7 segment LED displays

1 LED for general alarm indication

1 SPDT dry contact for general alarm remote warning

Undervoltage on DC BUS < 22 Vdc

Overvoltage on DC BUS > 110 Vdc

Brake resistor overtemperature (if the temperature sensor is present)

Module Internal overtemperature > 90°C (194°F)

Brake resistor interrupted or not connected

Short circuit : braking current > 80 A

Overload : braking time > 1 s

Protections

Parallel connection

Up to 4 units can be connected in parallel through synchronization bus for a total braking power of 8kW (4 x 2kW braking resistors are needed)

## GENERAL TECHNICAL DATA

Dissipated power
Operating temperature range
Input/output isolation
Input/ground isolation
Output/ground isolation
Standard/approvals

## 20 W

0...+70°C

500 Vac / 60s

IEC950, EN60950 for SELV use up to 60Vdc; using the MBC2K at voltages greater than 60Vdc is not classifiable as SELV

EN55011 Class B

1 / 2

IP 20 IEC 529, EN60529

1.5 and 2.5 mm<sup>2</sup> pluggable screw type

aluminium

200 g

vertical on rail, allow 10 mm spacing between adjacent components

120 g

vertical on rail, adjacent

EMC Standards
Overvoltage category/Pollution degree
Protection degree
Connection terminal
Housing material
Approx. weight
Mounting information
Approx. weight
Mounting information

## MOUNTING ACCESSORIES

Mounting rail type according to IEC60715/TH35-7.5
Mounting rail type according to IEC60715/G32

## PR/3/AC, PR/3/AC/ZB, PR/3/AS, PR/3/AS/ZB



# AC Surge Protection Devices

These are Surge Protection Devices (SPD) that prevent transitional impulsive overvoltage, conducted via the mains power supply, the earth network or signal networks, from damaging electronic command and control systems and electronic appliances in general. Series BY7 protection devices limit dangerous overvoltage to standard levels tolerated by the appliances intended for use in Overvoltage Category II or greater (impulsive overvoltage max. 2.5kV) in zone protected from overvoltage B and C (Zones 1 and 2) if the plant does not have a lightning arrester, in protection zone C (Zone 2) if the plant has a lightning arrester, and are SPD in Test Class II as required by standards IEC1024, IEC1312-1, EN50083-1 in force (see figure 1 the following pages)

## Where and how to use them

In accordance with current standards, series BY7 surge protection devices must be installed on incoming power lines to electrical distribution and control and command boards for automation, in order to guarantee immunity to the transistors of the equipment contained, such as PLC, industrial PCs, power supplies, inverters, etc.. For command and control boards, generally in Overvoltage Category II according to IEC EN 644-1 to be compliant with EMC standards, maximum impulsive overvoltage applied to equipment must be below 2.5kV, as indeed is also required by EN61000-4-4, 4-5. If SPDs with residual overvoltage of less than 2.5kV, which can be withstood by equipment, are not installed on command and control boards, overvoltage may cause plant or machine failure or breakdown, with costs that certainly exceed the cost of the SPDs. Installation of SDPs is also required, in any case, in order to comply with EMC standards and CE marking of the board.

## Performance

They consist of a wiring socket that can be assembled onto a DIN rail and a removable protection module that contains the discharge, making it easy to disconnect the SPD during insulation tests or for quick replacement at the end of its working life. They are able to withstand ten 20kA impulses of I<sub>sc</sub> discharge current with impulse 8/20 and a single 40kA impulse, which is statistically very rare. As required by the product regulations on the SPDs, the BY7 series is equipped with an automatic thermal cut-off device able to disconnect the line transformer in the event of failure, providing an indication of the failure discharge visible on the front of the unit and via a clean contact. When, after numerous discharges and years of service the module has deteriorated, it can be rapidly replaced by removing it from its base socket and replacing it with another, identical one, without disconnecting the power supply.

## Fuses and protection devices

BY7 series overvoltage dischargers have an incorporated device that disconnects the transformer at the end of its working life (close to short circuit or short circuited). They must, however, be fitted with protection against short circuit current upstream and differential protection against indirect contact (generally already included in the installation). If installed downstream of highly sensitive differential protection devices, we recommend using the configuration with gas discharger (see layouts on the following pages). The diagrams below illustrate an example protection connection according to priority type.

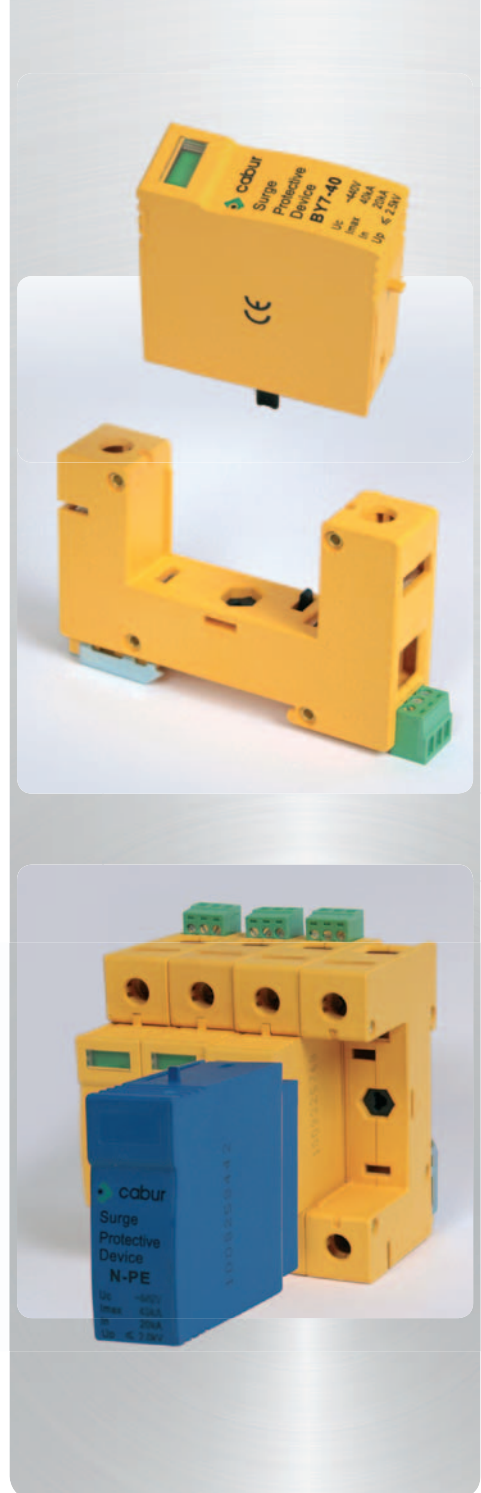

## Protection takes priority

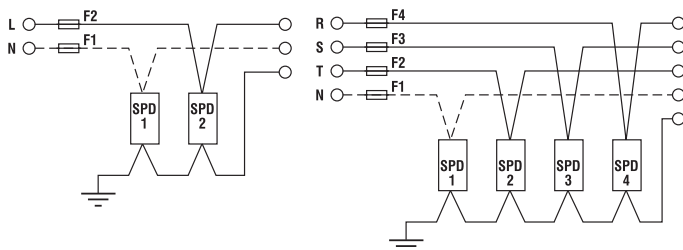

## Continuity of services takes priority

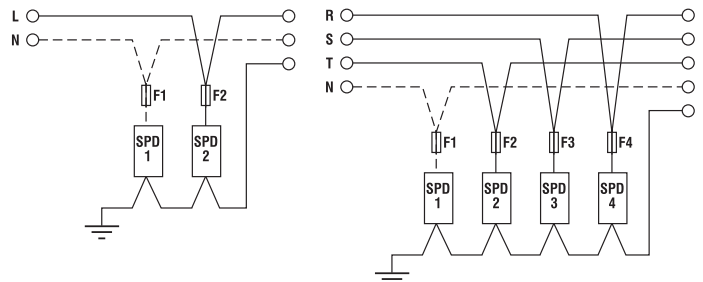



# Surge Protection Devices

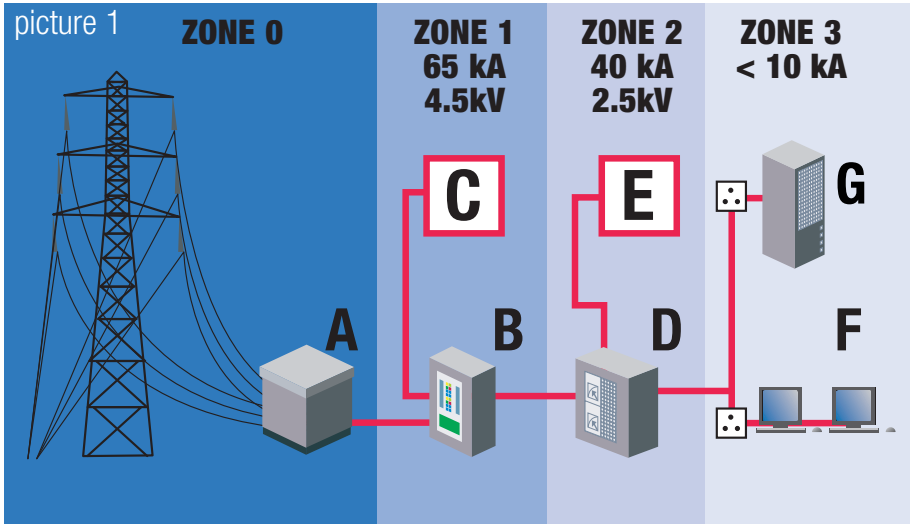

**Lightning protection zones**  
**Zone 0** - Zone where items are subject to direct lightning strikes or where an unattenuated electromagnetic field occurs as a result of the strike.  
**Zone 1** - Zone where items are subject to low level direct lightning strikes. The conducted impulse lightning currents and/or switching surges are reduced compared with Zone 0.  
**Zone 2** - Remnants of lightning impulse currents and/or switching surges are reduced compared with Zone 1.  
**Zone 3** - Surges, caused by oscillation effects, magnetic field couplings and internal switching surges are reduced compared with Zone 2

**A** - Sub Station  
**B** - Main distribution board  
**C** - Heavy machinery  
**D** - Local distribution board  
**E** - Light machinery  
**F** - Workstation  
**G** - Equipment

## Example of connection for different networks

### TN 3-phase system

No. 4 ISPD14440 +  
 No. 1 screw jumper 9000394



#### BLOCK DIAGRAM

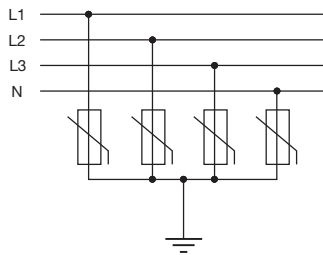

### TT 3-phase system

No. 3 ISPD14440 +  
 No. 1 ISPD1444G +  
 No. 1 screw jumper 9000394



#### BLOCK DIAGRAM

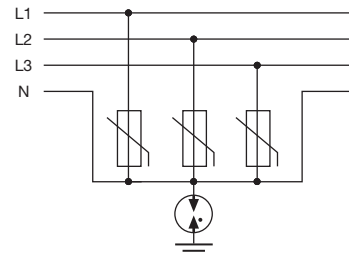

### TN single phase system

No. 2 ISPD14275 +  
 No. 1 screw jumper 9000392



#### BLOCK DIAGRAM

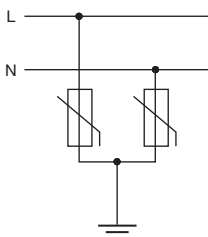

### TT single phase system

No. 1 ISPD14275 +  
 No. 1 ISPD1425G +  
 No. 1 screw jumper 9000392



#### BLOCK DIAGRAM

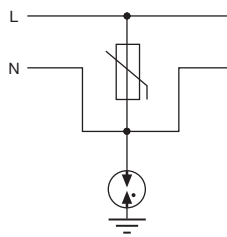

### TT single phase system

No. 2 ISPD14275 +  
 No. 1 ISPD1425G +  
 No. 1 screw jumper 9000393



#### BLOCK DIAGRAM

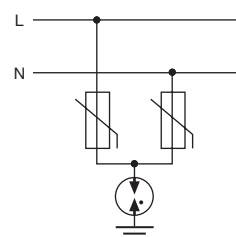

# Surge protection devices

- Rugged contacts
- Pluggable protection
- Efficiency status indicator on front panel
- Available screw jumpers for parallel conection

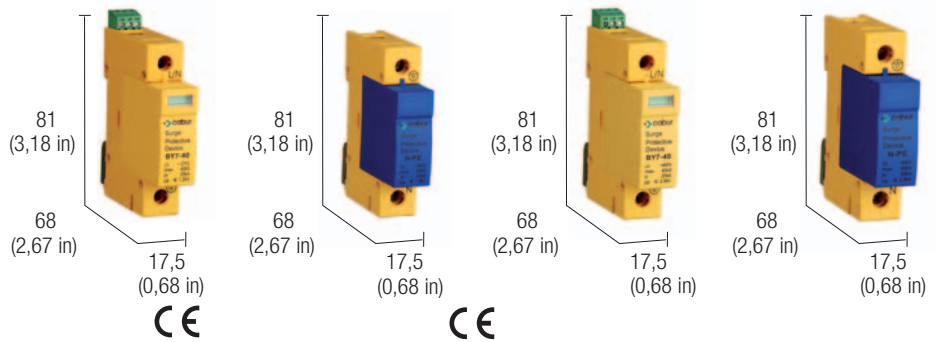

## NOTES

(1) When the thermal protection disconnects the SPD, the contacts 11-14 open and contacts 11-12 close

## BLOCK DIAGRAM



## VERSIONS

**Cod. ISPD14275**

**Cod. ISPD1425G**

**Cod. ISPD14440**

**Cod. ISPD1444G**

**BY7-40/1-275**

**BY7-NPE/40-275**

**BY7-40/1-440**

**BY7-NPE/40-440**

## ELECTRICAL TECHNICAL DATA

Category	II	II	II	II
Type of network systems	TN-S; TN-C; TT; IT	TN-S; TN-C; TT; IT	TN-S; TN-C; TT; IT	TN-S; TN-C; TT; IT
Tecnology	MOV (Metal Oxide Varistor)	GDT (Gas Discharge T)	MOV (Metal Oxide Varistor)	GDT (Gas Discharge Tube)
Rated voltage	Un 230 Vac	Un 230 Vac	Un 400 Vac	Un 400 Vac
Maximum continuous voltage	Uc 275 Vac	Uc 255 Vac	Uc 440 Vac	Uc 440 Vac
Voltage protection level	Up ≤ 1.200 V	Up ≤ 1.800 V	Up ≤ 2.000 V	Up ≤ 1.800 V
Normal discharge current (8/20)	In 20 kA	In 30 kA	In 20 kA	In 30 kA
Maximum discharge surge current (8/20)	I <sub>max</sub> 40 kA	I <sub>max</sub> 40 kA	I <sub>max</sub> 40 kA	I <sub>max</sub> 40 kA

## GENERAL TECHNICAL DATA

Connection terminal	4 ... 25 mm <sup>2</sup> fixed screw type			
Response time	t <sub>a</sub> < 25 nS			
Operating temperature range	-40°C < T < 80°C			
Status display	Green OK / Red FAILURE	No	Green OK / Red FAILURE	No
Remote signal	SPDT 1 A/230 Vac (1)	No	SPDT 1 A/230 Vac (1)	No
Remote signal connection	1,5 mm <sup>2</sup> pluggable 6 A - 120 V	No	1,5 mm <sup>2</sup> pluggable 6 A - 120 V	No
Housing material	UL94V0	UL94V1	UL94V2	UL94V3
Protection degree	IP20	IP21	IP22	IP23
Colour	Yellow	Blue	Yellow	Blue
Packaging quantity	1	1	2	3
Approx. Weight	135 g	95 g	135 g	95 g
Mounting information	vertical on rail, without spacing between adjacent components			

## MOUNTING ACCESSORIES

Mounting rail type according to IEC60715/TH35-7.5	<b>PR/3/AC, PR/3/AC/ZB, PR/3/AS, PR/3/AS/ZB</b>			
Replacement varistor				
Screw type jumper	2 poles		Cod. 9000392 (BP2)	
	3 poles		Cod. 9000393 (BP3)	
	4 poles		Cod. 9000394 (BP4)	

# Adjustable electronic overcurrent protection from 1...10 A / 24 Vdc



According to the new EN60204-1 Std. it is **compulsory** to protect wires on SELV-PELV lines against the effects of surges. The standard requires that surge protection devices on 24 Vdc cut the fault off before the 24 Vdc control drops below 21.6 V, disconnecting power to controls and preventing the starting of emergency and safety functions.

According to EN 60204-1 and EN 61131-1 and -2, surge protection devices on SELV-PELV lines must be able to disconnect shorts within 10 ms and dangerous surges within 5 s. The use of power supplies with high output surge capacity and precise and quick protection devices enables to cut faults off before 24 V drops below 21.6 V disconnecting power to controls.

Fuses and magneto-thermic switches on 24 Vdc lines do not have I / t features enabling to quickly and precisely cut faults off; moreover fuses may be replaced with different types thus altering the system's protection and safety.

The correct coordination of the circuitry into which the surge protection device is incorporated must take into account the line's total R: R connections + R wires + R protection + residual R of the damaged load. R total value must always enable that the protection device's tripping current may flow in the circuit; it is also important to avoid undersizing the protection device in order to prevent inconvenient trips due to the load's breakaway starting I, or oversizing it thus increasing t of intervention.

The whole circuitry made up of power supply, surge protection device, wires and connections must be designed so as to enable the safe interruption of surges within 5 s before 24 Vdc drops below 21.6 Vdc. This condition may be met using Cabur's power supplies - series CSF and CSG - dimensioned to supply high output surge (>+50% of rat.I for >5 s) and electronic surge protection devices with CEP System which are more precise and quicker than magneto-thermic switches and devices whose tripping t does not depend upon ambient T and may be reset with local or remote controls.

## Features of protection devices

Mgts have two different intervention curves: Thermal and Magnetic. The magnetic relay trips exclusively in the event of a short with different I / t curves: thermal relays have all the same intervention curve, regardless of the mgt curve and in the event of a surge, they operate as described in figure 2: surge currents  $1.13 \times I_n$  are cut in  $>1h$  and with surges  $> 1.45 \times I_n$ , the tripping takes place in a few minutes.

The disconnection of short currents is carried out by a magnetic relay whose tripping t goes from 0.01 to 0.1 sec, with very high currents which the power supply may not be able to supply; an mgt C5 used on DC has  $>70 A$  safe tripping, a current that only power supplies with much higher rated I, i.e. 40 A, may be able to supply (and not all of them) and that can not be supplied by 10 A power supplies.

Using mgt as surge protection device, if the power supply has a surge I 1.2 times its rat. I, disconnection will take place in 20...60 min, while with 2.5 currents higher than rat.I it will take place between 25 sec. and 2 min., depending on amb.T., whose times are too long to ensure the stability of 24 V, for protecting wires and the selectivity of protection devices. In the event of a failure - until the protection device trips - the power supply remains with a higher surge of  $I_n \times 1.5 \times 5s$  and 24 V drops below 21.6 V leaving standard functions and most of all safety functions with no power supply.

## Selectivity of protection devices

In the event of a surge or a short, only the damaged circuit is disconnected by its protection device with no repercussions on the supply of the other loads. This function is obtained with power supplies having high surge capacity and quick and precise protection devices.

## CEP system - a smart system for current's control

CEP "recognizes" surges at their lowest and more precise stage and disconnects the damaged circuit as quickly as possible. For an excellent flexible use, the CEP system allows to set 10 tripping currents ranging from 1A to 10 A in 1 A steps and 3 intervention curves "Fast - Normal - Delayed" (see figure 3).

The protection status is displayed by two leds and by a remote alarm transistor output; the load may be activated / deactivated by pressing a button on the front (figure 5) or by the PLC remote control. The possibility of separately controlling single channels is useful during installation, because the various components may be separately activated and tested and - in big systems - the remote control may be used in order to gradually activate loads thus preventing simultaneous overloads when the system is started up. Another important features in terms of safety is the possibility of manually disconnecting the load, which means that even when protection devices are reset from the remote control, the load will remain inactive thus preventing dangerous situations.



figure 1

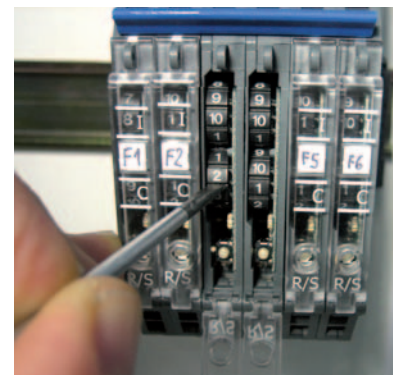

figure 3

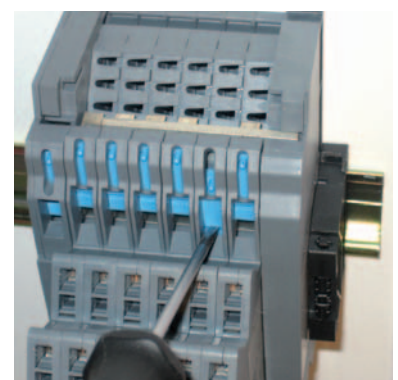

figure 4



figure 5

# Programmable electronic overcurrent protection 1...10 A / 24 Vdc

- Programmable from 1 A to 10 A in 1 A steps
- 3 programmable characteristic curves
- Remote or local ON/OFF control
- Status signal with LED and remote signal
- Slide contact for the manual load disconnection
- Sealable front cover allows to protect the set up of the protection

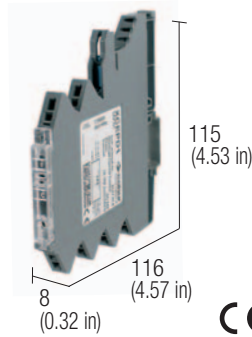

- 1) sealable front cover
- 2) current selector
- 3) identification label
- 4) characteristic curve selector
- 5) ste/reset button

## NOTES

The measures include the overall dimensions and the fixing to the guide.

(1) Version available upon request; for information call our sales department, local agent or representative

(2) 24 Vdc remote pulse switch the protection at falling edge. The pulse duration must be: ON = pulse > 1 s / OFF = pulse > 100 ms and < 800 ms

(3) The three standard intervention curves are described in the graphics; the C EP-D3 Version is also provided with a curve programmable through a software

## VERSIONS

With overload indication

With status indication (ON/OFF/Overload)

With one wire bus

## INPUT TECHNICAL DATA

Rated voltage

Rated current

Max system current

Protection

Remote control ON/OFF

## OUTPUT TECHNICAL DATA

Rated voltage

Current min. / max.

Programmable characteristic curves

Switch ON capacity

Status indication

Status display

## GENERAL TECHNICAL DATA

Operating temperature range

Input/output isolation

Protection degree

Reference Standards

Connection terminal

Housing material

Approx. weight

Mounting information

## MOUNTING ACCESSORIES

Mounting rail type according to IEC60715/TH35-7.5

Mounting rail type according to IEC60715/G32

Distribution kit (terminal + end bracket)

Distribution rail (busbar)

Insulation cover for distribution rail

Plug-in jumper

red

blue

Marking tag

## BLOCK DIAGRAM

Cod. XCEPD1	Cod. XCEPD2	Cod. XCEPD3
CEP-D1	CEP-D2 (1)	CEP-D3 (1)
<b>24 Vdc</b> (range 18...32 Vdc) 10 A dc max. 40 A dc with CEP-RCC copper rail Internal against reverse polarity		
24 Vdc external pulse		24 Vdc external pulse and by software (2)
<b>24 Vdc</b> (voltage drop <170 mV @ Un / In) 1...10 A dc programmable in 10 step of 1 A slow, medium, fast 10.000 µF green LED: fixed = ok, flashing = lout at 90% of the nominal, red LED: fixed = output manually switched off, slow flashing = overcurrent, quick flashing = error open collector transistor (overcurrent status)   open collector transistor (ON/OFF status)   open collector transistor (programmable status)		
-25...+60°C, derating I <sub>max</sub> 8 A over 40°C 3 kVac / 60 s SELV output IP 20 IEC 529, EN60529 EN60950-1, EN61131-1, EN61131-2, EN60898, EN60947-4-1, EN50081 0.25...2.5 mm <sup>2</sup> fixed screw type PA 6.6 (UL94V-0, NFF I2, F2) 120 g (4.24 oz)		
vertical on rail, adjacent without gap, we recommend the use of end brackets		
<b>PR/3/AC, PR/3/AC/ZB, PR/3/AS, PR/3/AS/ZB</b>		
CEP-SS	(cod. XCEPSS)	
CEP-RCC	(cod. XCEPRCC)	
CEP-RCP	(cod. XCEPRCP)	
CEP-BCR	(cod. XCEPBCR)	(8 poles)
CEP-BCB	(cod. XCEPBCB)	(8 poles)
CEP-MTW	(cod. XCEPMTW)	(table with 50 tags)

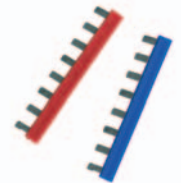

CEP-BCR and CEP-BCB



CEP-MTW



CEP-SS

Intervention curves:

- 1) fast
- 2) medium
- 3) slow

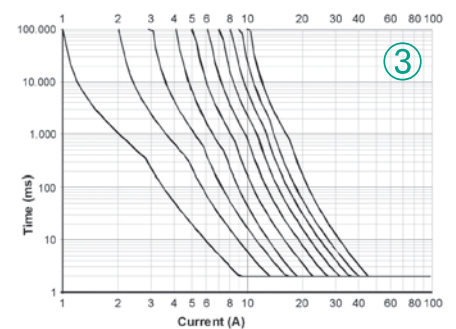
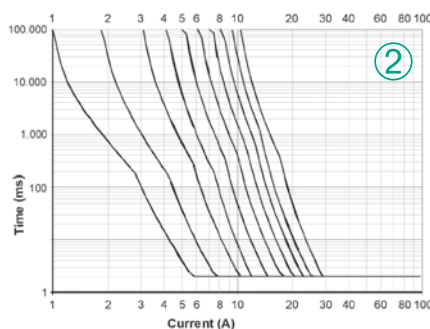
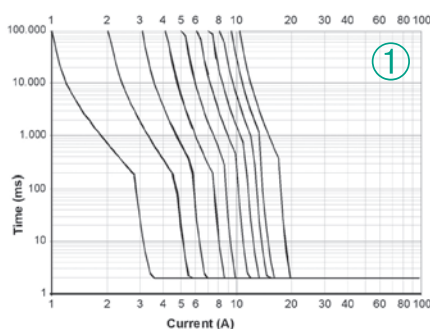



# EMI filters quick selection table

These tables allow you to quickly select only the items, then check if all product's technical data meet your application requirements.

## 3-phase filter without neutral wire 400-480 Vac

Current	Common mode (L / PE) attenuation (dB)						Differential mode (L / L) attenuation (dB)						Cat. No.	Page
	0.15 MHz	0.5 MHz	1 MHz	5 MHz	10 MHz	30 MHz	0.15 MHz	0.5 MHz	1 MHz	5 MHz	10 MHz	30 MHz		
7 A	20	60	60	60	50	35	25	60	65	60	55	40	XF07TDVST2	68
16 A	15	50	55	60	50	35	25	55	60	60	55	40	XF16TDVST2	68
30 A	15	50	55	60	50	35	25	55	60	60	55	40	XF30TDVST2	68
42 A	55	70	70	45	35	20	45	45	45	45	45	30	XF42TDVST2	68
55 A	15	55	55	55	50	35	25	55	60	60	50	40	XF55TDVST2	68
75 A	15	55	55	55	50	30	20	50	50	50	55	40	XF75TDVST2	68
100 A	35	50	45	25	15	7	30	35	35	35	30	7	XF100TDVST2	68
150 A	20	30	40	45	40	30	30	40	40	45	40	25	XF150TDS84C	69
180 A	20	30	40	45	40	30	30	40	40	45	40	25	XF180TDS84C	69
200 A	55	60	55	30	20	–	45	30	25	10	10	5	XF200TDDS84C	70
300 A	30	30	23	10	8	5	35	30	25	14	10	5	XF300TDDS84C	71
400 A	30	30	20	10	5	2	30	30	20	10	8	2	XF400TDDS84C	71

## 3-phase filter with neutral wire 400-480 Vac

Current	Common mode (L / PE) attenuation (dB)						Differential mode (L / L) attenuation (dB)						Cat. No.	Page
	0.15 MHz	0.5 MHz	1 MHz	5 MHz	10 MHz	30 MHz	0.15 MHz	0.5 MHz	1 MHz	5 MHz	10 MHz	30 MHz		
10 A	10	20	20	20	30	25	10	20	25	25	30	30	XF10TYG9	73
16 A	25	50	50	50	45	30	35	55	60	60	40	30	XF16TYT2	72
20 A	10	15	20	35	40	25	10	15	20	20	25	20	XF20TYS9	73
25 A	25	50	50	50	45	30	35	55	60	60	40	30	XF25TYT2	72
36 A	25	50	50	50	40	25	30	50	55	50	40	30	XF36TYT2	72
50 A	25	45	45	40	40	25	30	50	50	40	40	30	XF50TYT2	72
100 A	10	20	25	30	30	20	30	40	40	35	35	25	XF100TYT2	72

## Single-cell single-phase filter 120-250 Vac

Current	Common mode (L / PE) attenuation (dB)						Differential mode (L / L) attenuation (dB)						Cat. No.	Page
	0.15 MHz	0.5 MHz	1 MHz	5 MHz	10 MHz	30 MHz	0.15 MHz	0.5 MHz	1 MHz	5 MHz	10 MHz	30 MHz		
3 A	20	30	35	45	50	45	7	35	50	45	45	45	XF03DKBG5B	74
6 A	15	20	25	40	45	45	10	20	45	45	50	45	XF06DKBG5B	74
12 A	10	20	22	35	45	40	10	20	40	45	45	45	XF12DKBG5B	74
16 A	10	18	20	35	45	30	10	18	40	40	40	35	XF16DKCG5B	74
20 A	10	18	20	30	35	35	10	12	35	35	40	40	XF20DKCG5B	74
30 A	10	25	30	45	50	35	12	40	50	50	50	45	XF30DKCS5B	74

## Double-cell single-phase filter 120-250 Vac

Current	Common mode (L / PE) attenuation (dB)						Differential mode (L / L) attenuation (dB)						Cat. No.	Page
	0.15 MHz	0.5 MHz	1 MHz	5 MHz	10 MHz	30 MHz	0.15 MHz	0.5 MHz	1 MHz	5 MHz	10 MHz	30 MHz		
3 A	45	60	60	55	45	45	12	45	45	45	45	45	XF03DPCG5C	75
6 A	30	50	60	55	50	35	8	45	45	45	45	45	XF06DPCG5C	75
12 A	15	25	35	55	55	35	12	40	40	35	35	40	XF12DPCG5C	75
16 A	20	35	45	60	50	35	12	40	40	45	45	50	XF16DPCG5C	75
20 A	15	40	45	50	50	40	12	45	45	45	35	50	XF20DPCG5C	75
30 A	10	30	35	55	45	30	18	45	50	40	40	40	XF30DPCG5C	75



## 3-phase filter without neutral TDV series

- Models from 7 to 130 A
- High attenuation from 50 kHz to 30 MHz
- High attenuation also with long cables
- Minimum space on the panel

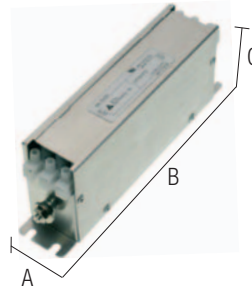

### NOTES

Dimensions and diagrams are indicative, for more details see the products data sheet.

(1) According to EN60950 insulation tests on input side must be made only with DC instruments.

(2) Version available upon request; for information call our sales department, local agent or representative

### BLOCK DIAGRAM

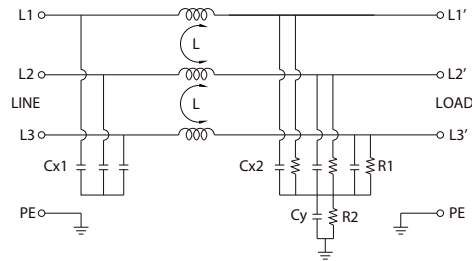

VERSIONS			Dimensions			Weight
Rated current	Type	Cat. No.	A	B	C	(kg)
7 A	<b>F 07 TDV ST2</b>	XF07TDVST2 (2)	42 (1,65 in)	192 (7,56 in)	72 (2,84 in)	
16 A	<b>F 16 TDV ST2</b>	XF16TDVST2 (2)	47 (1,85 in)	252 (9,93 in)	72 (2,84 in)	
30 A	<b>F 30 TDV ST2</b>	XF30TDVST2 (2)	52 (2,05 in)	272 (10,72 in)	87 (3,43 in)	
42 A	<b>F 42 TDV ST2</b>	XF42TDVST2 (2)	52 (2,05 in)	312 (12,29 in)	87 (3,43 in)	
55 A	<b>F 55 TDV ST2</b>	XF55TDVST2 (2)	87 (3,43 in)	252 (9,93 in)	92 (3,62 in)	
75 A	<b>F 75 TDV ST2</b>	XF75TDVST2 (2)	92 (3,62 in)	272 (10,72 in)	137 (5,4 in)	
100 A	<b>F 100 TDV ST2</b>	XF100TDVST2 (2)	90 (3,55 in)	270 (10,64 in)	150 (5,91 in)	

  

GENERAL TECHNICAL DATA	
Rated voltage	480 Vac ± 10%
Rated current	see versions table
Frequency	50...60 Hz
Leakage current at 480 Vac 60 Hz	30 mA
Operating temperature range	-25...+85°C
Insulation L/L	1.45 KVdc / 60 s (1)
Insulation L/PE	2.25 KVdc / 60 s (1)
Overvoltage category/Pollution degree	—
Protection degree	IP 20 IEC 529, EN60529
Connection terminal	screw terminals
Housing material	metal
Approx. weight	see versions table
Mounting information	on the panel with screws

Type	Common mode (L / PE) attenuation (dB)						Differential mode (L / L) attenuation (dB)					
	0.15 MHz	0.5 MHz	1 MHz	5 MHz	10 MHz	30 MHz	0.15 MHz	0.5 MHz	1 MHz	5 MHz	10 MHz	30 MHz
<b>F 07 TDV ST2</b>	20	60	60	60	50	35	25	60	65	60	55	40
<b>F 16 TDV ST2</b>	15	50	55	60	50	35	25	55	60	60	55	40
<b>F 30 TDV ST2</b>	15	50	55	60	50	35	25	55	60	60	55	40
<b>F 42 TDV ST2</b>	55	70	70	45	35	20	45	45	45	45	45	30
<b>F 55 TDV ST2</b>	15	55	55	55	50	35	25	55	60	60	50	40
<b>F 75 TDV ST2</b>	15	55	55	55	50	30	20	50	50	50	55	40
<b>F 100 TDV ST2</b>	35	50	45	25	15	7	30	35	35	35	30	7

# 3-phase filter without neutral TDS series

- Models from 150 to 180 A
- High attenuation from 150 kHz to 30 MHz
- High attenuation also with long cables

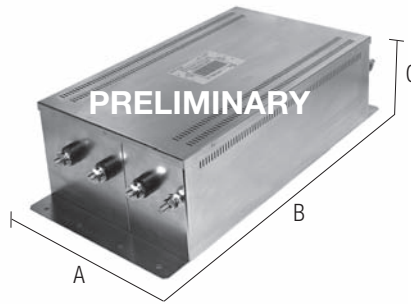

## NOTES

Dimensions and diagrams are indicative, for more details see the products data sheet.

- (1) Version available upon request; for information call our sales department, local agent or representative  
 (2) According to EN60950 insulation tests on input side must be made only with DC instruments.

## BLOCK DIAGRAM

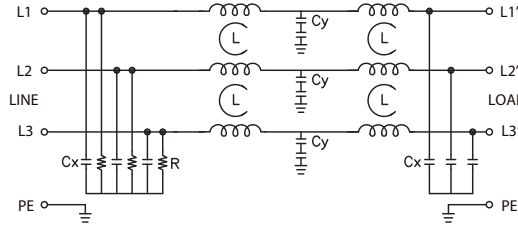

## VERSIONS

Rated current	Type	Cat. No.
150 A	<b>F 150 TDS 84C</b>	XF150TDS84C (1)
180 A	<b>F 180 TDS 84C</b>	XF180TDS84C (1)

## Dimensions

A	B	C	Weight (kg)
202 (7,96 in)	390 (15,37 in)	122 (4,81 in)	
202 (7,96 in)	390 (15,37 in)	122 (4,81 in)	

## GENERAL TECHNICAL DATA

Rated voltage	480 Vac $\pm$ 10%
Rated current	see versions table
Frequency	50...60 Hz
Leakage current at 480 Vac 60 Hz	500 mA
Operating temperature range	-25...+85°C
Insulation line/line	1 KVdc / 60 s (2)
Insulation line/PE	1 KVdc / 60 s (150A) – 2.25 KVdc / 60 s (180A) (2)
Overvoltage category/Pollution degree	—
Protection degree	IP 20 IEC 529, EN60529
Connection terminal	with screw bolts
Housing material	metal
Approx. weight	see versions table
Mounting information	on the panel with screws

Type	Common mode (L / PE) attenuation (dB)						Differential mode (L / L) attenuation (dB)					
	0.15 MHz	0.5 MHz	1 MHz	5 MHz	10 MHz	30 MHz	0.15 MHz	0.5 MHz	1 MHz	5 MHz	10 MHz	30 MHz
<b>F 150 TDS 84C</b>	20	30	40	45	40	30	30	40	40	45	40	25
<b>F 180 TDS 84C</b>	20	30	40	45	40	30	30	40	40	45	40	25

## 3-phase filter without neutral serie TDDS

- High attenuation from 150 kHz to 30 MHz
- High attenuation also with long cables

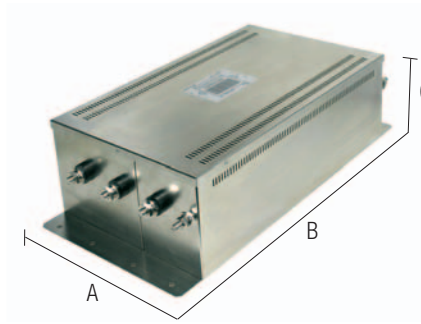

### NOTES

Dimensions and diagrams are indicative, for more details see the products data sheet.

- (1) Version available upon request; for information call our sales department, local agent or representative  
 (2) According to EN60950 insulation tests on input side must be made only with DC instruments.

### BLOCK DIAGRAM

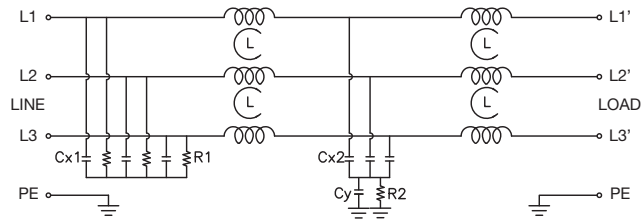

### VERSIONS

Rated current	Type	Cat. No.
200 A	<b>F 200 TDDS 84C</b>	XF200TDDS84C (1)

### Dimensions

A	B	C
240 (9,46 in)	477 (18,79 in)	140 (5,52 in)

### Weight (kg)

### GENERAL TECHNICAL DATA

Rated voltage	480 Vac $\pm$ 10%
Rated current	200 A
Frequency	50...60 Hz
Leakage current at 480 Vac 60 Hz	500 mA
Operating temperature range	-25...+85°C
Insulation line/line	1 KVdc / 60 s (2)
Insulation line/PE	1.8 KVdc / 60 s (2)
Overvoltage category/Pollution degree	—
Protection degree	IP 20 IEC 529, EN60529
Connection terminal	with screw bolts
Housing material	metal
Approx. weight	see versions table
Mounting information	on the panel with screws

Type	Common mode (L / PE) attenuation (dB)						Differential mode (L / L) attenuation (dB)					
	0.15 MHz	0.5 MHz	1 MHz	5 MHz	10 MHz	30 MHz	0.15 MHz	0.5 MHz	1 MHz	5 MHz	10 MHz	30 MHz
<b>F 200 TDDS 84C</b>	55	60	55	30	20	/	45	30	25	10	10	5

## 3-phase filter without neutral TDSS series

- Models from 300 to 600 A
- High attenuation from 150 kHz to 30 MHz
- High attenuation also with long cables

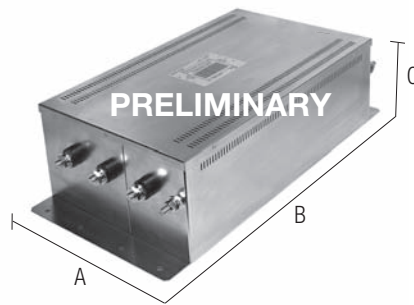

### NOTES

Dimensions and diagrams are indicative, for more details see the products data sheet.

- (1) Version available upon request; for information call our sales department, local agent or representative  
 (2) According to EN60950 insulation tests on input side must be made only with DC instruments.

### BLOCK DIAGRAM

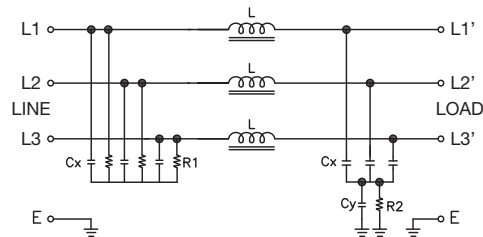

VERSIONS			Dimensions			Weight
Rated current	Type	Cat. No.	A	B	C	(kg)
300 A	<b>F 300 TDSS 84C</b>	XF300TDSS84C (1)	242 (9,53 in)	525 (20,69 in)	142 (5,59 in)	
400 A	<b>F 400 TDSS 84C</b>	XF400TDSS84C (1)	242 (9,53 in)	525 (20,69 in)	142 (5,59 in)	
GENERAL TECHNICAL DATA						
Rated voltage	480 Vac ± 10%					
Rated current	see versions table					
Frequency	50...60 Hz					
Leakage current at 480 Vac 60 Hz	1000 mA					
Operating temperature range	-25...+85°C					
Insulation line/line	0.6 KVdc / 60 s				(2)	
Insulation line/PE	1 KVdc / 60 s				(2)	
Overvoltage category/Pollution degree	—					
Protection degree	IP 20 IEC 529, EN60529					
Connection terminal	with flat plug					
Housing material	metal					
Approx. weight	see versions table					
Mounting information	on the panel with screws					

Type	Common mode (L / PE) attenuation (dB)						Differential mode (L / L) attenuation (dB)					
	0.15 MHz	0.5 MHz	1 MHz	5 MHz	10 MHz	30 MHz	0.15 MHz	0.5 MHz	1 MHz	5 MHz	10 MHz	30 MHz
<b>F 300 TDSS 84C</b>	30	40	40	25	20	15	40	40	50	35	30	20
<b>F 400 TDSS 84C</b>	25	35	30	20	20	10	40	35	35	20	15	10

# 3-phase filter with neutral serie TYT

- Models from 16 to 100 A
- High attenuation from 150 kHz to 30 MHz
- High attenuation also with long cables

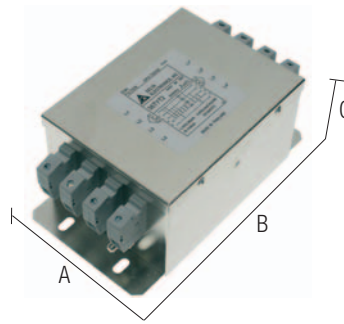

## NOTES

Dimensions and diagrams are indicative, for more details see the products data sheet.

(1) According to EN60950 insulation tests on input side must be made only with DC instruments.

(2) Version available upon request; for information call our sales department, local agent or representative

## BLOCK DIAGRAM

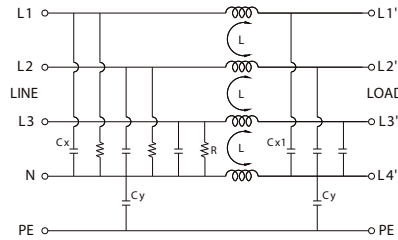

## VERSIONS

Rated current	Type	Cat. No.
16 A	<b>F 16 TYT2</b>	XF16TYT2 (2)
25 A	<b>F 25 TYT2</b>	XF25TYT2 (2)
36 A	<b>F 36 TYT2</b>	XF36TYT2 (2)
50 A	<b>F 50 TYT2</b>	XF50TYT2 (2)
100 A	<b>F 100 TYT2</b>	XF100TYT2 (2)

## Dimensions

A	B	C	Weight (kg)
107 (4,22 in)	191,5 (7,55 in)	82 (3,23 in)	
107 (4,22 in)	191,5 (7,55 in)	82 (3,23 in)	
107 (4,22 in)	191,5 (7,55 in)	82 (3,23 in)	
124 (4,89 in)	194 (7,64 in)	104 (4,1 in)	
162 (6,38 in)	252 (9,93 in)	132 (5,2 in)	

## GENERAL TECHNICAL DATA

Rated voltage	440 Vac $\pm$ 10%
Rated current	see versions table
Frequency	50...60Hz
Leakage current at 480 Vac 60 Hz	3 mA
Operating temperature range	-25...+85°C
Insulation line/line	1.45 KVdc / 60 s (1)
Insulation line/PE	2.25 KVdc / 60 s (1)
Overvoltage category/Pollution degree	—
Protection degree	IP 20 IEC 529, EN60529
Connection terminal	screw terminals
Housing material	metal
Approx. weight	see versions table
Mounting information	on the panel with screws

Type	Common mode (L / PE) attenuation (dB)						Differential mode (L / L) attenuation (dB)					
	0.15 MHz	0.5 MHz	1 MHz	5 MHz	10 MHz	30 MHz	0.15 MHz	0.5 MHz	1 MHz	5 MHz	10 MHz	30 MHz
<b>F 16 TYT2</b>	25	50	50	50	45	30	35	55	60	60	40	30
<b>F 25 TYT2</b>	25	50	50	50	45	30	35	55	60	60	40	30
<b>F 36 TYT2</b>	25	50	50	50	40	25	30	50	55	50	40	30
<b>F 50 TYT2</b>	25	45	45	40	40	25	30	50	50	40	40	30
<b>F 100 TYT2</b>	10	20	25	30	30	20	30	40	40	35	35	25



# Compact 3-phase filter with neutral TY series

- Models from 10 to 20 A
- High attenuation from 150 kHz to 30 MHz
- High attenuation also with long cables
- Excellent quality/price/performance ratio

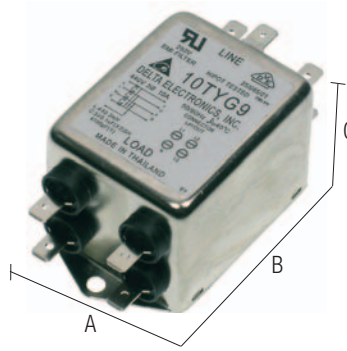

## NOTES

Dimensions and diagrams are indicative, for more details see the products data sheet.

- (1) According to EN60950 insulation tests on input side must be made only with DC instruments.  
 (2) Version available upon request; for information call our sales department, local agent or representative

## BLOCK DIAGRAM

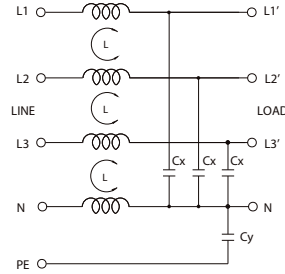

## VERSIONS

Rated current	Type	Cat. No.
10 A	<b>F 10 TYG9</b>	XF10TYG9 (2)
20 A	<b>F 20 TYS9</b>	XF20TYS9 (2)

## Dimensions

A	B	C	Weight (kg)
50 (1,97 in)	85 (3,35 in)	44 (1,73 in)	
50 (1,97 in)	97 (3,82 in)	44 (1,73 in)	

## GENERAL TECHNICAL DATA

Rated voltage	440 Vac ± 10%
Rated current	see versions table
Frequency	50...60Hz
Leakage current at 480 Vac 60 Hz	0.5 mA
Operating temperature range	-25...+85°C
Insulation line/line	1.45 KVdc / 60 s (1)
Insulation line/PE	2.25 KVdc / 60 s (1)
Overvoltage category/Pollution degree	—
Protection degree	IP 20 IEC 529, EN60529
Connection terminal	with flat plug (10 A) and with screw terminals (20 A)
Housing material	metal
Approx. weight	see versions table
Mounting information	on the panel with screws

Type	Common mode (L / PE) attenuation (dB)						Differential mode (L / L) attenuation (dB)					
	0.15 MHz	0.5 MHz	1 MHz	5 MHz	10 MHz	30 MHz	0.15 MHz	0.5 MHz	1 MHz	5 MHz	10 MHz	30 MHz
<b>F 10T YG9</b>	10	20	20	20	30	25	10	20	25	25	30	30
<b>F 20 TYS9</b>	10	15	20	20	25	20	10	15	20	20	25	20

# Single-cell single-phase filter DK series

- Models from 3 to 30 A
- High attenuation from 150 kHz to 30 MHz
- High attenuation also with long cables
- Minimum space on the panel

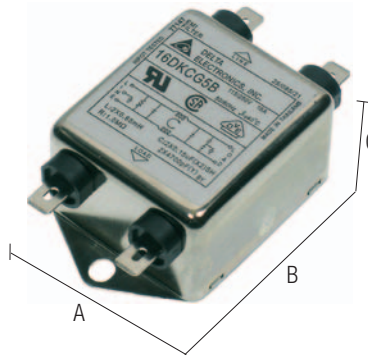

## NOTES

Dimensions and diagrams are indicative, for more details see the products data sheet.

- (1) 0.25 mA @ 115 Vac e 0.45 mA @ 250 Vac for models from 3...20 A - 1 mA @ 115 Vac e 2 mA @ 250 Vac for the model of 30 A.
- (2) Version available upon request; for information call our sales department, local agent or representative.
- (3) With flat plug for models from 3...20 A – with screw bolt for the model from 30 A.
- (4) According to EN60950 insulation tests on input side must be made only with DC instruments.

## BLOCK DIAGRAM

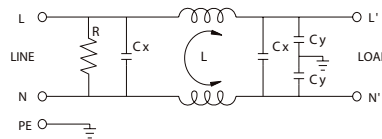

## VERSIONS

Rated current	Type	Cat. No.
3 A	<b>F 03 DK BG5B</b>	XF03DKBG5B (2)
6 A	<b>F 06 DK BG5B</b>	XF06DKBG5B (2)
12 A	<b>F 12 DK BG5B</b>	XF12DKBG5B (2)
16 A	<b>F 16 DK CG5B</b>	XF16DKCG5B (2)
20 A	<b>F 20 DK CG5B</b>	XF20DKCG5B (2)
30 A	<b>F 30 DK CS5B</b>	XF30DKCS5B (2)

## Dimensions

A	B	C	Weight (kg)
64,5 (2,54 in)	34 (1,34 in)	30 (1,18 in)	
64,5 (2,54 in)	34 (1,34 in)	30 (1,18 in)	
64,5 (2,54 in)	34 (1,34 in)	30 (1,18 in)	
45,5 (1,79 in)	71,5 (2,82 in)	30 (1,18 in)	
51,8 (2,04 in)	84,8 (3,34 in)	30 (1,18 in)	
56,5 (2,23 in)	114 (4,49 in)	46,4 (1,83 in)	

## GENERAL TECHNICAL DATA

Rated voltage	115–250 Vac ± 10%
Rated current	see versions table
Frequency	50...60 Hz
Leakage current at 480 Vac 60 Hz	0.25...1 mA / 0.45...2 mA (1)
Operating temperature range	–25...+85°C
Insulation line/line	1.45 KVdc / 60 s (4)
Insulation line/PE	2.25 KVdc / 60 s (4)
Overvoltage category/Pollution degree	—
Protection degree	IP 20 IEC 529, EN60529
Connection terminal	with flat plug (from 3 to 20 A) / with screw bolt (30 A) (3)
Housing material	metal
Approx. weight	see versions table
Mounting information	on the panel with screws

Type	Common mode (L / PE) attenuation (dB)						Differential mode (L / L) attenuation (dB)					
	0.15 MHz	0.5 MHz	1 MHz	5 MHz	10 MHz	30 MHz	0.15 MHz	0.5 MHz	1 MHz	5 MHz	10 MHz	30 MHz
<b>F 03 DK BG5B</b>	20	30	35	45	50	45	7	35	50	45	45	45
<b>F 06 DK BG5B</b>	15	20	25	40	45	45	10	20	45	45	50	45
<b>F 12 DK BG5B</b>	10	20	22	35	45	40	10	20	40	45	45	45
<b>F 16 DK CG5B</b>	10	18	20	35	45	30	10	18	40	40	40	35
<b>F 20 DK CG5B</b>	10	18	20	30	35	35	10	12	35	35	40	40
<b>F 30 DK CS5B</b>	10	25	30	45	50	35	12	40	50	50	50	45

# Double-cell single-phase filter DP series

- Models from 3 to 30 A
- High attenuation from 150 kHz to 30 MHz
- High attenuation also with long cables
- Minimum space on the panel

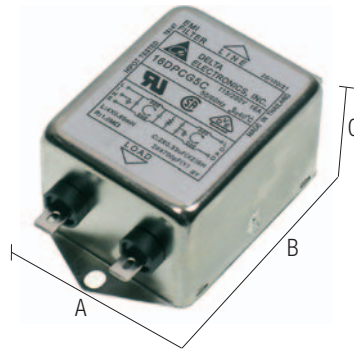

## NOTES

Dimensions and diagrams are indicative, for more details see the products data sheet.

- (1) 0.25 mA @ 115 Vac e 0.45 mA @ 250 Vac for models from 3...20 A - 1 mA @ 115 Vac e 2 mA @ 250 Vac for the model of 30 A.
- (2) Version available upon request; for information call our sales department, local agent or representative.
- (3) With flat plug for models from 3...20 A – with screw bolt for the model from 30 A.
- (4) According to EN60950 insulation tests on input side must be made only with DC instruments.

## BLOCK DIAGRAM

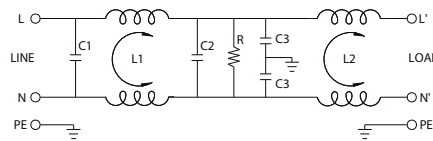

## VERSIONS

Rated current	Type	Cat. No.
3 A	<b>F 03 DP CG5C</b>	XF03DPCG5C (2)
6 A	<b>F 06 DP CG5C</b>	XF06DPCG5C (2)
12 A	<b>F 12 DP CG5C</b>	XF12DPCG5C (2)
16 A	<b>F 16 DP CG5C</b>	XF16DPCG5C (2)
20 A	<b>F 20 DP CG5C</b>	XF20DPCG5C (2)
30 A	<b>F 30 DP GS5C</b>	XF30DPGS5C (2)

## Dimensions

A	B	C	Weight (kg)
84,8 (3,34 in)	75 (2,96 in)	52 (2,05 in)	
152,9 (6,02 in)	143 (5,63 in)	51,3 (2,02 in)	
84,8 (3,34 in)	75 (2,96 in)	52 (2,05 in)	
56,5 (2,23 in)		46,4 (1,83 in)	

## GENERAL TECHNICAL DATA

Rated voltage	115–250 Vac ± 10%
Rated current	see versions table
Frequency	50...60 Hz
Leakage current at 480 Vac 60 Hz	0.25...1 mA / 0.45...2 mA (1)
Operating temperature range	–25...+85°C
Insulation line/line	1.45 KVdc / 60 s (4)
Insulation line/PE	2.25 KVdc / 60 s (4)
Overvoltage category/Pollution degree	—
Protection degree	IP 20 IEC 529, EN60529
Connection terminal	with flat plug (from 3 to 20 A) / with screw bolt (30 A) (3)
Housing material	metal
Approx. weight	see versions table
Mounting information	on the panel with screws

Type	Common mode (L / PE) attenuation (dB)						Differential mode (L / L) attenuation (dB)					
	0.15 MHz	0.5 MHz	1 MHz	5 MHz	10 MHz	30 MHz	0.15 MHz	0.5 MHz	1 MHz	5 MHz	10 MHz	30 MHz
<b>F 03 DP CG5C</b>	45	60	60	55	45	45	12	45	45	45	45	45
<b>F 06 DP CG5C</b>	30	50	60	55	50	35	8	45	45	45	45	45
<b>F 12 DP CG5C</b>	15	25	35	55	55	35	12	40	40	35	35	40
<b>F 16 DP CG5C</b>	20	35	45	60	50	35	12	40	40	45	45	50
<b>F 20 DP CG5C</b>	15	40	45	50	50	40	12	45	45	40	35	50
<b>F 30 DP GS5C</b>	10	30	35	55	45	30	18	45	50	40	40	40

# Analogue signal converters

## Applications of analogue signal converters and galvanic isolation

These convert electric signals generated by sensors for measuring physical quantities such as: temperature (RTD thermocouples and PT100 thermal resistors), frequency (proximity, contacts, photoelectric cells), current (HV, Hall sensors), resistance (potentiometers), voltage, pressure, level etc., into standardised electrical signals, adapting them to the I/O of industrial PLC's, DCS's, and PC's (control), or they convert a given analogue signal into a different one, adapting it to the inputs/outputs of the control, or allow remote transmission of the signal without interference via galvanic isolation (Fig. 1).

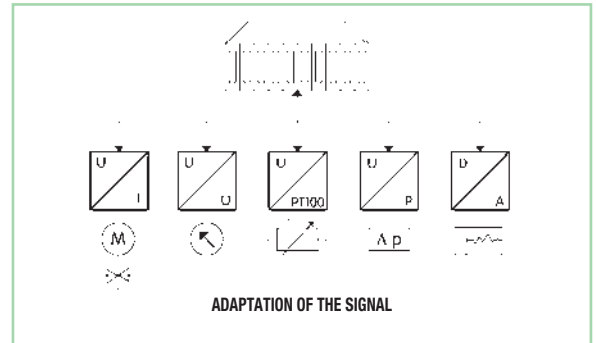

fig. 1

### Adaptation between sensor output signal and control input signal

physical quantity measured	sensor output	converter input		converter output	
Temperature	Normally one of the signals indicated in the next column	0 – 60 mV	±60 mV	0 – 5 V	±5 V
Frequency		0 – 100 mV	±100 mV	0 – 10 V	±10 V
Current		0 – 500 mV	±500 mV	0 – 20 mA	±20 mA
Resistance		0 – 1 V	±1 V	4 – 20 mA	
Voltage		0 – 5 V	±5 V		
Pressure		0 – 10 V	±10 V		
Level measurement		0 – 5 mA	±5 mA		
		0 – 10 mA	±10 mA		
		0 – 20 mA	±20 mA		
		0 – 20 mA			

### Remote transmission of the signal

The voltage signals reach a max. distance of 10-20 m, beyond this they lose reliability and become very sensitive to earth and induced interference for this reason, in order to transmit at a distance more than 20 m, a voltage signal must be converted into a current signal and galvanically isolated. (Fig. 2).

Current signals exceed 300 m of transmission distance and are less sensitive to induced interference. In order to transmit a current signal at a distance galvanic isolation is required.

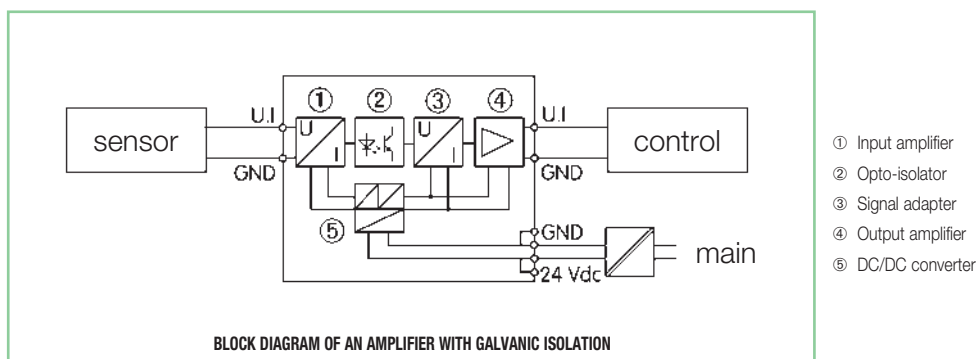

fig. 2

### Galvanic isolation of the signal:

- electrically isolates and separates the circuit of the sensor from the control and power supply circuits. Thus each circuit operates with reference to its own zero potential which, being isolated from other circuits, cannot be altered by differences in potential always present between different earth references (Figs. 3).

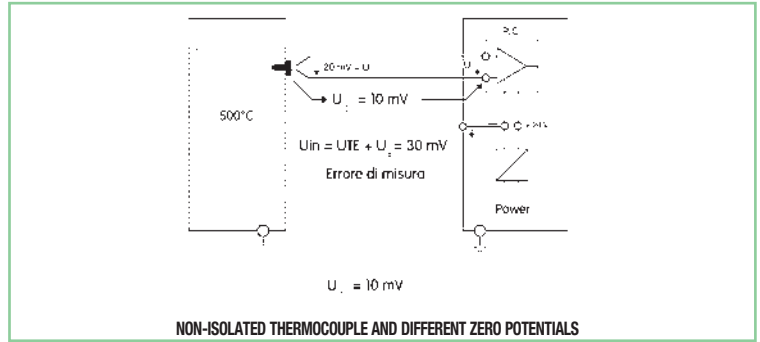

fig. 3

- isolates and separates the various zero potentials between power supply, control and sensors/actuators;
- allows transmission of the signal without errors or interference and with greater reliability;
- the higher the isolation (in kV), the greater the security of transmission where there are zero potentials, electromagnetic interference, transients (lightning, discharges etc.) (Fig. 4).

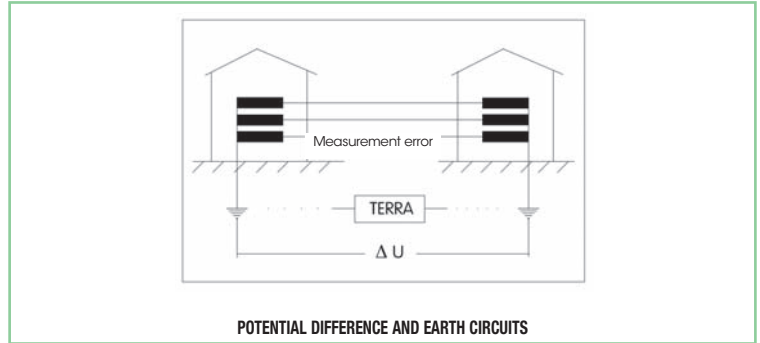

fig. 4

### Galvanic isolation is necessary when:

- the distance between control and sensor/actuator is more than 20 m;
- the earth references are different;
- the zero potentials are high, or potentially high in the case of discharges or earth dispersed currents;
- electromagnetic interference is present;
- the signal cables are wired in conduits with power cables (Fig. 5).

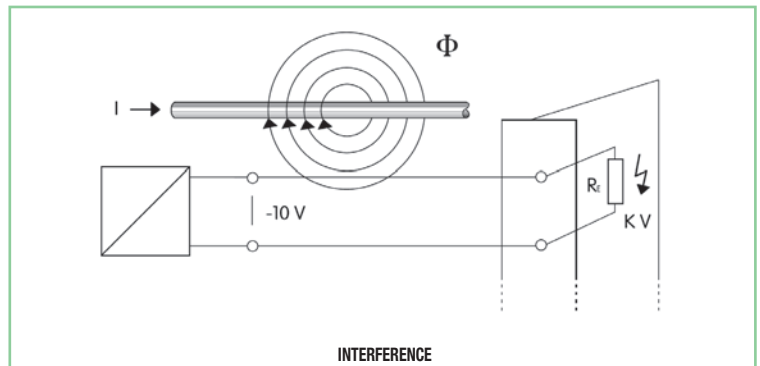

fig. 5

### Series and parallel connection of the analogue converters

- To achieve redundancy of a signal or just to duplicate it, you can connect the input of more analogue converters to a single sensor.
- In case of current signals, the input of the converters must be connected in series (Fig. 6).

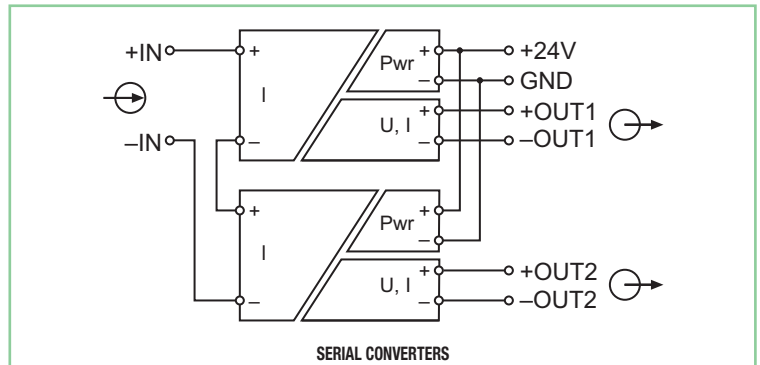

fig. 6

- In case of voltage signals, the input of the converters must be connected in parallel (Fig. 7).

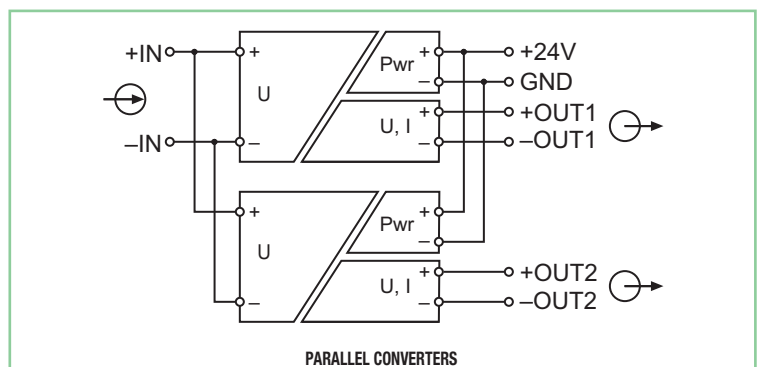

fig. 7



# Analogue converters selection table

These tables allow you to quickly select only the items, then check if all product's technical data meet your application requirements.

## Analogue signal converters and galvanic isolators

Input	Output	Isolation	Power supply	Notes	Type	Cat. No.	Page
0...60 / 0...100 / 0...500 mV ±60 / ±100 / ±500 mV 0...1 / 0...2 / 0...5 / 0...10 V ±1 / ±2 / ±5 / ±10 V 0...5 / 0...10 / 0...20 / 4...20 mA ±5 / ±10 / ±20 mA	0...5 / 0...10 / ±5 / ±10 V 0...20 / 4...20 / ±20 mA	3 ways	24 Vdc	(1) (4)	CA-PI/PO1	XSSAPIPO1	81
0...60 / 0...100 / 0...300 / 0...500 mV 0...1 / 0...10 / 0...20 / 2...20 V 0...5 / 0...10 / 0...20 / 4...20 / ±5 / ±20 mA	0...10 V 0...20 / 4...20 mA	3 ways	24 Vac/dc	(1) (4)	CWUAA 6-0516	X756516	82
0...60 / 0...100 / 0...300 / 0...500 mV 0...1 / 0...10 / 0...20 / 2...20 V 0...5 / 0...10 / 0...20 / 4...20 / ±5 / ±20 mA	0...10 V 0...20 / 4...20 mA	3 ways	24...240 Vac/dc	(1) (5)	CWUAA 6-0517	X756517	82
0...10 V 0...20 / 4...20 mA	0...10 V 0...20 / 4...20 mA	3 ways	24 Vac/dc	(1) (4)	CWNAA 7-0539	X756539	83
0...10 V 0...20 / 4...20 mA	0...10 V 0...20 / 4...20 mA	3 ways	24...240 Vac/dc	(1) (5)	CWNAA 6-0510	X756510	83
0...10 V	0...10 V	3 ways	24 Vac/dc	(2) (4)	CWAA 6-0530	X756530	84
0...10 V	0...20 mA	3 ways	24 Vac/dc	(2) (4)	CWAA 6-0531	X756531	84
0...10 V	4...20 mA	3 ways	24 Vac/dc	(2) (4)	CWAA 6-0532	X756532	84
0...20 mA	0...10 V	3 ways	24 Vac/dc	(2) (4)	CWAA 6-0533	X756533	85
0...20 mA	0...20 mA	3 ways	24 Vac/dc	(2) (4)	CWAA 6-0534	X756534	85
0...20 mA	4...20 mA	3 ways	24 Vac/dc	(2) (4)	CWAA 6-0535	X756535	85
4...20 mA	0...10 V	3 ways	24 Vac/dc	(2) (4)	CWAA 6-0536	X756536	86
4...20 mA	0...20 mA	3 ways	24 Vac/dc	(2) (4)	CWAA 6-0537	X756537	86
4...20 mA	4...20 mA	3 ways	24 Vac/dc	(2) (4)	CWAA 6-0538	X756538	86
0...20 / 4...20 mA	0...20 / 4...20 mA	2 ways	—	(4)	CWPAA 7-0526	X756526	87
0...20 / 4...20 mA	0...20 / 4...20 mA	2 ways	—	(3) (4)	CWPAA 7-0527	X756527	87
-30...+30 V / -50...+50 mA / -5...+5 A	0...20 / 4...20 mA	3 ways	24 Vdc	(6) (7)	LCONALSFDT	X756360	88

- Notes**
- (1) programmable input and output signal via DIP switches
  - (2) single range input and output signal (not programmable), articles generally not in stock but available upon request, for info please contact our sales department
  - (3) two channels version
  - (4) 1.5 kVac / 60 s two way isolation (input / output) or 1.5 kVac / 60 s three way isolation (input / output / supply)
  - (5) 4 kVac / 60 s three way isolation (input / output / supply)
  - (6) Input and Output signal range programmable via dip-switch and software
  - (7) 2.5 kVac / 60 three way isolation (input / output / supply)

# Analogue converters selection table

These tables allow you to quickly select only the items, then check if all product's technical data meet your application requirements.

## Current transducers and limit value switch

Input	Output	Isolation	Power supply	Notes	Type	Cat. No.	Page
0...50 A ac	adjustable threshold 1...30 A	2 ways	24 Vdc	(3) (4)	CCIS-2	XCCIS2	93
0...1 A ac/dc	0...10 V 0...20 / 4...20 mA	2 ways	24 Vdc	(2)	WAA 7-0540	X756540	94
0...5 A ac/dc	0...10 V 0...20 / 4...20 mA	2 ways	24 Vdc	(2)	WAA 7-0541	X756541	94
0...10 A ac/dc	0...10 V 0...20 / 4...20 mA	2 ways	24 Vdc	(2)	WAA 7-0542	X756542	94

### Notes

(1) single I/O version

(2) three programmable output signals

(3) open collector threshold output

(4) threshold output with one changeover relay

## Frequency signal converter

Input	Output	Isolation	Power supply	Notes	Type	Cat. No.	Page
0...28.8 kHz (21 ranges)	0...10 V 0...20 / 4...20 mA	2 ways	24 Vac/dc	(1)	CWNFA 6-0524	X756524	97

## Auxiliary power supply for sensors and potentiometers

Input	Output	Isolation	Power supply	Notes	Type	Cat. No.	Page
24 Vdc	10 Vdc	2 Vie			CWCV 7-6184	X766184	98

## NPN and PNP signal polarity inverter

Input	Output	Isolation	Power supply	Notes	Type	Cat. No.	Page
NPN (17...30 Vdc)	PNP				CI-NPN/PNP	XNPNPNP	99
PNP (17...30 Vdc)	NPN				CI-NPN/PNP	XNPNPNP	99

# Analog converters selection table

These tables allow you to quickly select only the items, then check if all product's technical data meet your application requirements.

## Temperature transducers

Sensor Type	Input	Output	Isolation	Power supply	Notes	Type	Cat. No.	Page
PT100 e PT1000 (2, 3, 4 wires), Thermocouples B, C, E, J, K, N, R, S, T, Potentiometers 0-600 kOhm	Programmable -200...+2400°C (-328...+4352°F) according to sensor type	0...10 V / -10...+10 V 0...20 mA / 4...+20 mA	3 ways	24 Vdc	(1) (2)	LCONTADFDT	X756340	89
PT100 e PT1000 (2, 3, 4 wires), Thermocouples B, C, E, J, K, N, R, S, T, Potentiometers 0-600 kOhm	Programmable -200...+2400°C (-328...+4352°F) according to sensor type	2 thresholds (NO contacts)	3 ways	24 Vdc	(2)	LCONTLSFDT	X756370	90
PT100 3 wire (RTD)	-50...+50°C (-58...+122°F) -50...+100°C (-58...+212°F) -50...+150°C (-58...+302°F) 0...+100°C (+32...+212°F) 0...+150°C (+32...+302°F) 0...+200°C (+32...+392°F) 0...+300°C (+32...+572°F) 0...+400°C (+32...+752°F)	0...10 V 0...20 / 4...20 mA	3 ways	24 Vac/dc	(2)	CWPT 6-0816	X756816	91
PT100 3 wire (RTD)	-50...+50°C (-58...+122°F) -50...+100°C (-58...+212°F) -50...+150°C (-58...+302°F) 0...+100°C (+32...+212°F) 0...+150°C (+32...+302°F) 0...+200°C (+32...+392°F) 0...+300°C (+32...+572°F) 0...+400°C (+32...+752°F)	0...10 V 0...20 / 4...20 mA	3 ways	24...240 Vac/dc	(2)	CWPT 6-0817	X756817	91
Thermocouples J (FeCuNi) and K (NiCrNi)	-50...+200°C (-58...+392°F) -50...+350°C (-58...+662°F) 0...+200°C (+32...+392°F) 0...+400°C (+32...+752°F) 0...+600°C (+32...+1112°F) 0...+800°C (+32...+1472°F) 0...+1000°C (+32...+1832°F) 0...+1200°C (+32...+2192°F)	0...10 V 0...20 / 4...20 mA	3 ways	24 Vac/dc	(2)	CWTH 6-0844	X756844	92
Thermocouples J (FeCuNi) and K (NiCrNi)	-50...+200°C (-58...+392°F) -50...+350°C (-58...+662°F) 0...+200°C (+32...+392°F) 0...+400°C (+32...+752°F) 0...+600°C (+32...+1112°F) 0...+800°C (+32...+1472°F) 0...+1000°C (+32...+1832°F) 0...+1200°C (+32...+2192°F)	0...10 V 0...20 / 4...20 mA	3 ways	24...240 Vac/dc	(2)	CWTH 6-0847	X756847	92

**Notes**  
 (1) programmable input and output signals via software  
 (2) programmable input and output signals via dip-switch

# Programmable analogue signal converter

- 19 input scales
- 7 output scales
- 1 SPST (NO) alarm contact
- IN/OUT isolation >3 kVac
- Auxiliary supply output for loop-powered sensors
- Input for potentiometer

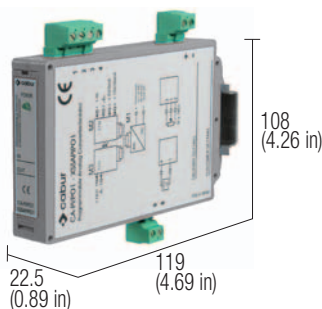

## NOTES

The dimensions includes the terminal blocks and the DIN clamp.

(1) The modules in stock are programmed and calibrated with with 0...10 V and 0...10 V output. Modules programmed and calibrated for all other possible configurations can be supplied on request.

## BLOCK DIAGRAM

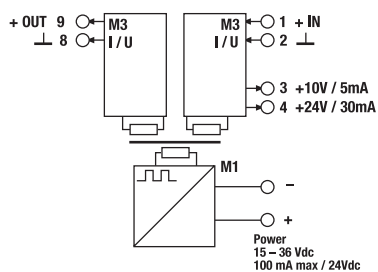

## VERSIONS

Cat. No. XCAPI03

CAPI03

## INPUT TECHNICAL DATA

Input signal (1)	19 programmable ranges (see Table 1)
Impedance voltage / current mode	1 M $\Omega$ / 50 $\Omega$
Max. input voltage	15 V
Max. input current	30 mA

## OUTPUT TECHNICAL DATA

Output signal (1)	7 programmable ranges (see Table 2)
Applicable load (voltage / current model)	$\geq 10$ k $\Omega$ / $\leq 500$ $\Omega$
Max. output voltage	12 V
Max. output current	25 mA

## GENERAL TECHNICAL DATA

Supply voltage	15...36 Vdc
Rated current	100 mA max. @ 24 Vdc
Auxiliary DC feed output max. current	10 Vdc 5 mA / 24 Vdc 30 mA
Gain error	< 0.1% FS
Offset error	< 0.05% FS
Linearity error	< 0.1% FS
Zero adjustment / Span adjustment	$\pm 10\%$ FS
Transmission frequency	400Hz...1kHz according to full-scale
Rise time	150 mV / $\mu$ s
Bandwidth	1 kHz @ -6 dB
Phase delay	< 10 $\mu$ s
I/O / supply isolation	> 3 kVac / 60 s
Continuous voltage isolation	800 Vac max.
Reference Standard	IEC 664-1, DIN VDE0110.1
Overvoltage category/Pollution degree	III / 2
Operating temperature range	-10... +65°C
$\Delta$ T	5°C
Protection degree	IP 20 IEC 529, EN60529
ECM standards	EN 50081-2, EN 50082-2
Connection terminal	2.5 mm <sup>2</sup> pluggable screw type (14 AWG)
Housing material	polyamide UL94V-0
Approx. weight	150 g (5.29 oz)
Mounting information	vertical on rail, allow 5 mm spacing between adjacent component

## MOUNTING ACCESSORIES

Mounting rail type according to IEC60715/TH35-7.5	PR/3/AC, PR/3/AC/ZB, PR/3/AS, PR/3/AS/ZB
Mounting rail type according to IEC60715/G32	—
Plug-in jumper	red white blue

TAB.1 - INPUT SELECTION TABLE

INPUT RANGE		SW1 (INPUT)							
UNIPOLAR	BIPOLAR	1	2	3	4	5	6	7	8
0 – 60 mV	$\pm 60$ mV								
0 – 100 mV	$\pm 100$ mV		•						
0 – 500 mV	$\pm 500$ mV			•					
0 – 1 V	$\pm 1$ V				•				
0 – 2 V	$\pm 2$ V						•		
0 – 5 V	$\pm 5$ V			•	•	•	•		
0 – 10 V	$\pm 10$ V								•
0 – 5 mA	$\pm 5$ mA	•		•					
0 – 10 mA	$\pm 10$ mA	•			•				
0 – 20 mA	$\pm 20$ mA	•						•	
4 – 20 mA	—	•							•

TAB.2 - OUTPUT SELECTION TABLE

OUTPUT RANGE	INPUT TYPE	SW2 (OUTPUT)								SW3
		1	2	3	4	5	6	7	8	
0 – 5 V	UNIP.	X								U
	BIP.	X	•	•				•	•	U
$\pm 5$ V	UNIP.	X			•					U
	BIP.	X		•				•		U
0 – 10 V	UNIP.	X		•						U
	BIP.	X	•	•					•	U
$\pm 10$ V	UNIP.	X			•					U
	BIP.	X		•						U
0 – 20 mA	UNIP.	X		•				X		I
	BIP.	X	•	•				X	•	I
$\pm 20$ mA	UNIP.	X		•				X		I
	BIP.	X		•				X		I
4 – 20 mA	UNIP.	X				•	•	X		I
	BIP.	X	•			•	•	X	•	I

• = ON  
= OFF  
X = ANY

## INPUT STAGE

The module can manage single-pole and two-pole inputs, choosing from among the ranges (see Table 1):

- 0...60 mV  $\pm 60$  mV
- 0...100 mV  $\pm 100$  mV
- 0...500 mV  $\pm 500$  mV
- 0...1 V  $\pm 1$  V
- 0...5 V  $\pm 5$  V
- 0...10 V  $\pm 10$  V
- 0...5 mA  $\pm 5$  mA
- 0...10 mA  $\pm 10$  mA
- 0...20 mA  $\pm 20$  mA
- 4...20 mA

The input stage provides two auxiliary supply outputs, for feeding loop powered sensor and potentiometer directly from the module (10V e 24V).

Example of connection:

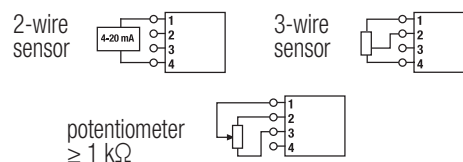

## OUTPUT STAGE

The module supplies in output single-pole and two-pole signals with the following ranges (see Table 2):

- 0...5 V  $\pm 5$  V
- 0...10 V  $\pm 10$  V
- 0...20 mA  $\pm 20$  mA
- 4...20 mA

# Programmable analogue signal converters

- 3 ways galvanic isolation
- 14 programmable input range
- 3 programmable output range
- Simple programming
- Available version with 24-240 Vac/dc supply voltage

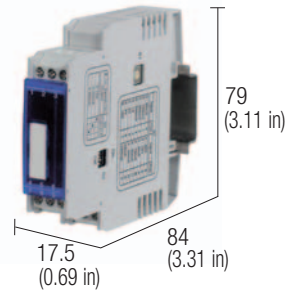

## NOTES

The dimensions includes the DIN clamp.

- (1) Adjustable via rotary-switch
- (2) Adjustable via dip-switch
- (3) range 16.8...30 Vdc / 19.2...28.8 Vac
- (4) range 16.8...264 Vdc / 19.2...264 Vac
- (5) 3-way isolation: IN/OUT/power supply
- (6) Version available upon request; for information call our sales department, local agent or representative

## BLOCK DIAGRAM

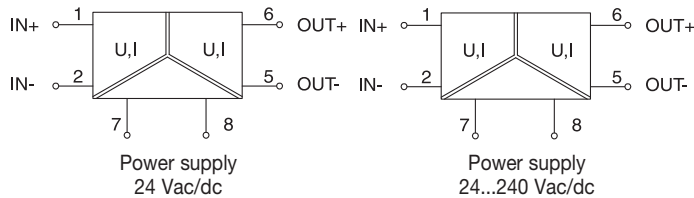

## VERSIONS

- 24 Vac/dc supply voltage
- 24-240 Vac/dc supply voltage

## INPUT TECHNICAL DATA

Input signal (1)

Input resistance

## OUTPUT TECHNICAL DATA

Output signal (2)

Applicable load

## GENERAL TECHNICAL DATA

Supply voltage

Rated current

Accuracy

Transmission frequency

Temperature coefficient

Isolation

ECM standards

Reference Standard

Overvoltage category/Pollution degree

Protection degree

Operating temperature range

Connection terminal

Housing material

Approx. weight

Mounting information

## Cat. No. X756516

CWUAA 6-0516

0...60 / 0...100 / 0...300 / 0...500 mV  
0...1 / 0...10 / 0...20 / 2...20 V  
0...5 / 0...10 / 0...20 / 4...20 / ±5 / ±20 mA  
330 kΩ with input voltage  
100 Ω with input current

0...10 V  
0...20 / 4...20 mA

>1 kΩ with output voltage  
<400 Ω with output current

24 Vac/dc (3)

≤ 35 mA ± 10% @ 24 Vdc

0.1% @ 23°C FS

< 30 Hz

0.02% / K FS

1.5 kVac / 60 s (5)

EN 50081-2, EN 50082-2

IEC 664-1, DIN VDE

III / 2

IP 20 IEC 529, EN60529

-25...+60°C

2.5 mm<sup>2</sup> fixed screw type

Noryl UL94V-0

65 g (2.29 oz)

vertical on rail adjacent without gap

## Cat. No. X756517

CWUAA 6-0517 (6)

0...60 / 0...100 / 0...300 / 0...500 mV  
0...1 / 0...10 / 0...20 / 2...20 V  
0...5 / 0...10 / 0...20 / 4...20 / ±5 / ±20 mA  
330 kΩ with input voltage  
100 Ω with input current

0...10 V  
0...20 / 4...20 mA

>1 kΩ with output voltage  
<400 Ω with output current

24-240 Vac/dc (4)

≤ 35 mA ± 10% @ 24 Vdc

0.1% @ 23°C FS

< 30 Hz

0.02% / K FS

4 kVac / 60 s (5)

EN 50081-2, EN 50082-2

IEC 664-1, DIN VDE

III / 2

IP 20 IEC 529, EN60529

-25...+60°C

2.5 mm<sup>2</sup> fixed screw type

Noryl UL94V-0

75 g (2.65 oz)

vertical on rail adjacent without gap

## APPLICATIONS

Multifunction converters can be used to convert and isolate the most common standard analogue signals; the input of the modules can be set up into 14 signal ranges and the output can be set up to 3 most important analogue ranges. The set up is possible by simply switching the position of a dip switch on the side of the module.

The many different input / output combinations offered by multifunctions modules allows to reduce inventory for both new and replacement products and provides many signal conversion solutions.

The "3 ways" galvanic isolation assures total isolation between input, output and supply input; this feature, and the "self calibrating signal circuitry", gives excellent accuracy without any manual adjustment.

If a single signal must provide several output channels it is possible to use many modules connecting their inputs in parallel as long as the signal is voltage, or in series when signal is current.

## MOUNTING ACCESSORIES

Mounting rail type according to IEC60715/TH35-7.5

Mounting rail type according to IEC60715/G32

Plug-in jumper

(16 poles, 16 A)

red

white

blue

PR/3/AC, PR/3/AC/ZB, PR/3/AS, PR/3/AS/ZB



# Programmable analogue signal converters

- 1.5 kV, 3 ways, IN/OUT/supply voltage isolation
- 3 programmable input range
- 3 programmable output range
- Simple programming and self calibrating

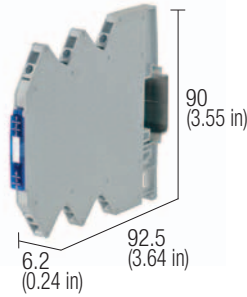

## NOTES

The dimensions includes the DIN clamp.  
 (1) range 16.8...30 Vdc / 19.2...28.8 Vac  
 (2) range 16.8...264 Vdc / 19.2...264 Vac  
 (3) 3-way isolation: IN/OUT/power supply

## BLOCK DIAGRAM

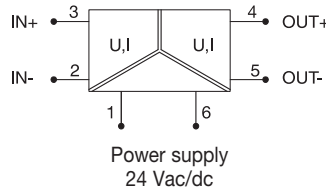

## VERSIONS

**24 Vac/dc supply voltage**  
**24-240 Vac/dc supply voltage**

Cod. X756539 —

CWNAA-7-0539 —

## INPUT TECHNICAL DATA

Input signal  
 Input resistance

**0...10 V**  
**0...20 / 4...20 mA**  
 330 kΩ with input voltage  
 100 Ω with input current

## OUTPUT TECHNICAL DATA

Output signal  
 Applicable load

**0...10 V**  
**0...20 / 4...20 mA**  
 >1 kΩ with output voltage  
 <400 Ω with output current

## GENERAL TECHNICAL DATA

Supply voltage  
 Rated current  
 Accuracy  
 Transmission frequency  
 Temperature coefficient  
 Isolation  
 ECM standards  
 Reference Standard  
 Overvoltage category/Pollution degree  
 Protection degree  
 Operating temperature range  
 Connection terminal  
 Housing material  
 Approx. weight  
 Mounting information

**24 Vac/dc** (1)  
 ≤ 35 mA ± 10% @ 24 Vdc  
 0.1% @ 23°C FS  
 < 30 Hz  
 0.02% / K FS  
 1.5 kVac / 60 s (3)  
 EN 61000-6-2, EN 61000-6-4  
 IEC 664-1, DIN VDE  
 III / 2  
 IP 20 IEC 529, EN60529  
 -25...+60°C  
 2.5 mm<sup>2</sup> fixed screw type  
 Noryl UL94V-0  
 40 g  
 vertical on rail adjacent without gap

## MOUNTING ACCESSORIES

Mounting rail type according to IEC60715/TH35-7.5  
 Mounting rail type according to IEC60715/G32  
 Plug-in jumper red  
 (16 poles, 16 A) white  
 blue

## PR/3/AC, PR/3/AC/ZB, PR/3/AS, PR/3/AS/ZB

—  
 CWBK 7-0802 cod. X766802 —  
 CWBK 7-0803 cod. X766803 —  
 CWBK 7-0804 cod. X766804 —

## APPLICATIONS

Multi-function converters can be used to convert and isolate the most common standard analogue signals; the input and the output can be set up into 3 different signal ranges. The set up is possible by simply switching the position of a dip switch on the side of the module.

The input / output combinations offered by these modules provide the most common input/output configurations more economically when compared to 14 input / 3 output modules and reduces inventory.

If a single signal must provide several output channels it is possible to use many modules connecting their inputs in parallel as long as the signal is voltage, or in series when signal is current.

# Analogue signal converters

- 1.5 kV, 3 ways, IN/OUT/supply voltage isolation
- Fixed value
- Compact dimension, 6.2 mm pitch

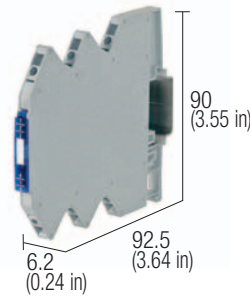

## NOTES

The dimensions includes the DIN clamp.  
 (1) range 16.8...30 Vdc / 19.2...28.8 Vac  
 (2) 3-way isolation: IN/OUT/power supply

## BLOCK DIAGRAM

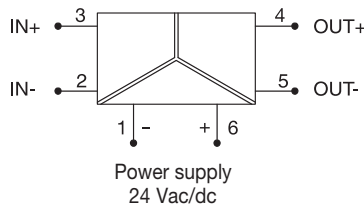

## VERSIONS

IN: 0...10 V / OUT: 0...10 V

IN: 0...10 V / OUT: 0...20 mA

IN: 0...10 V / OUT: 4...20 mA

## INPUT TECHNICAL DATA

Input signal

Input resistance

## OUTPUT TECHNICAL DATA

Output signal

Applicable load

## GENERAL TECHNICAL DATA

Supply voltage

Rated current

Accuracy

Transmission frequency

Temperature coefficient

Isolation

ECM standards

Reference Standard

Overvoltage category/Pollution degree

Protection degree

Operating temperature range

Connection terminal

Housing material

Approx. weight

Mounting information

Cat. No. X756530

Cat. No. X756531

Cat. No. X756532

CWAA 7-0530

CWAA 7-0531

CWAA 7-0532

0...10 V

0...10 V

0...10 V

330 k $\Omega$

330 k $\Omega$

330 k $\Omega$

0...10 V

0...20 mA

4...20 mA

>1 k $\Omega$

<400  $\Omega$

<400  $\Omega$

24 Vac/dc (1)

24 Vac/dc (1)

24 Vac/dc (1)

$\leq 13 \text{ mA} \pm 10\%$

$\leq 13 \text{ mA} \pm 10\%$

$\leq 13 \text{ mA} \pm 10\%$

0.1% @ 23°C FS

0.1% @ 23°C FS

0.1% @ 23°C FS

< 30 Hz

< 30 Hz

< 30 Hz

0.02% / K FS

0.02% / K FS

0.02% / K FS

1.5 kVac / 60 s (2)

1.5 kVac / 60 s (2)

1.5 kVac / 60 s (2)

EN 61000-6-2, EN 61000-6-4

EN 61000-6-2, EN 61000-6-4

EN 61000-6-2, EN 61000-6-4

IEC 664-1, DIN VDE

IEC 664-1, DIN VDE

IEC 664-1, DIN VDE

III / 2

III / 2

III / 2

IP 20 IEC 529, EN60529

IP 20 IEC 529, EN60529

IP 20 IEC 529, EN60529

-25...+60°C

-25...+60°C

-25...+60°C

2.5 mm<sup>2</sup> fixed screw type

2.5 mm<sup>2</sup> fixed screw type

2.5 mm<sup>2</sup> fixed screw type

PPE

PPE

PPE

40 g (1.41 oz)

40 g (1.41 oz)

40 g (1.41 oz)

vertical on rail adjacent without gap

vertical on rail adjacent without gap

vertical on rail adjacent without gap

## MOUNTING ACCESSORIES

Mounting rail type according to IEC60715/TH35-7.5

Mounting rail type according to IEC60715/G32

Plug-in jumper

(16 poles, 16 A)

red

white

blue

PR/3/AC, PR/3/AC/ZB, PR/3/AS, PR/3/AS/ZB

CWBK 7-0802 Cat. No. X766802

CWBK 7-0803 Cat. No. X766803

CWBK 7-0804 Cat. No. X766804

## APPLICATIONS

These converters can be used to convert and isolate the most common standard analogue signals; each model is designed for a single input output signal function, and they are the right solution in applications where many modules handling the same signal are used, where they allow a large cost reduction compared with multi function modules. These modules are provided with 3 ways galvanic isolation between input output and supply voltage. If a single signal must provide several output channels it is possible to use many modules connecting their inputs in parallel as long as the signal is voltage, or in series when the signal is current.

# Analogue signal converters

- 1.5 kV, 3 ways, IN/OUT/supply voltage isolation
- Fixed value
- Compact dimension, 6.2 mm pitch

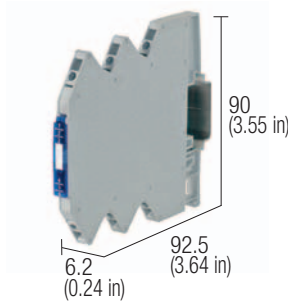

## NOTES

The dimensions includes the DIN clamp.  
 (1) range 16.8...30 Vdc / 19.2...28.8 Vac  
 (2) 3-way isolation: IN/OUT/power supply  
 (3) Version available upon request; for information call our sales department, local agent or representative

## BLOCK DIAGRAM

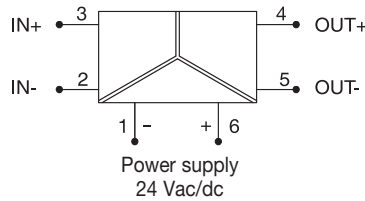

## VERSIONS

**IN: 0...20 mA / OUT: 0...10 V**  
**IN: 0...20 mA / OUT: 0...20 mA**  
**IN: 0...20 mA / OUT: 4...20 mA**

## INPUT TECHNICAL DATA

Input signal  
 Input resistance

## OUTPUT TECHNICAL DATA

Output signal  
 Applicable load

## GENERAL TECHNICAL DATA

Supply voltage  
 Rated current  
 Accuracy  
 Transmission frequency  
 Temperature coefficient  
 Isolation  
 ECM standards  
 Reference Standard  
 Overvoltage category/Pollution degree  
 Protection degree  
 Operating temperature range  
 Connection terminal  
 Housing material  
 Approx. weight  
 Mounting information

Cat. No. X756533	Cat. No. X756534	Cat. No. X756535
CWAA 7-0533 (3)	CWAA 7-0534 (3)	CWAA 7-0535 (3)
<b>0...20 mA</b>	<b>0...20 mA</b>	<b>0...20 mA</b>
100 Ω	100 Ω	100 Ω
<b>0...10 V</b>	<b>0...20 mA</b>	<b>4...20 mA</b>
>1 kΩ	<400 Ω	<400 Ω
<b>24 Vac/dc (1)</b>	<b>24 Vac/dc (1)</b>	<b>24 Vac/dc (1)</b>
≤ 13 mA ± 10%	≤ 13 mA ± 10%	≤ 13 mA ± 10%
0.1% @ 23°C FS	0.1% @ 23°C FS	0.1% @ 23°C FS
< 30 Hz	< 30 Hz	< 30 Hz
0.02% / K FS	0.02% / K FS	0.02% / K FS
1.5 kVac / 60 s (2)	1.5 kVac / 60 s (2)	1.5 kVac / 60 s (2)
EN 61000-6-2, EN 61000-6-4	EN 61000-6-2, EN 61000-6-4	EN 61000-6-2, EN 61000-6-4
IEC 664-1, DIN VDE	IEC 664-1, DIN VDE	IEC 664-1, DIN VDE
III / 2	III / 2	III / 2
IP 20 IEC 529, EN60529	IP 20 IEC 529, EN60529	IP 20 IEC 529, EN60529
-25...+60°C	-25...+60°C	-25...+60°C
2.5 mm <sup>2</sup> fixed screw type	2.5 mm <sup>2</sup> fixed screw type	2.5 mm <sup>2</sup> fixed screw type
PPE	PPE	PPE
40 g (1.41 oz)	40 g (1.41 oz)	40 g (1.41 oz)
vertical on rail adjacent without gap	vertical on rail adjacent without gap	vertical on rail adjacent without gap
<b>PR/3/AC, PR/3/AG/ZB, PR/3/AS, PR/3/AS/ZB</b>		
Plug-in jumper (16 poles, 16 A)	red white blue	CWBK 7-0802 Cat. No. X766802 CWBK 7-0803 Cat. No. X766803 CWBK 7-0804 Cat. No. X766804

## APPLICATIONS

These converters can be used to convert and isolate the most common standard analogue signals; each model is designed for a single input output signal function, and they are the right solution in applications where many modules handling the same signal are used, where they allow a large cost reduction compared with multi function modules. These modules are provided with 3 ways galvanic isolation between input output and supply voltage. If a single signal must provide several output channels it is possible to use many modules connecting their inputs in parallel as long as the signal is voltage, or in series when the signal is current.

## MOUNTING ACCESSORIES

Mounting rail type according to IEC60715/TH35-7.5  
 Mounting rail type according to IEC60715/G32

# Analogue signal converters

- 1.5 kV, 3 ways, IN/OUT/supply voltage isolation
- Fixed value
- Compact dimension, 6.2 mm pitch

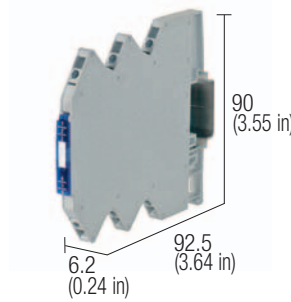

## NOTES

The dimensions includes the DIN clamp.  
 (1) range 16.8...30 Vdc / 19.2...28.8 Vac  
 (2) 3-way isolation: IN/OUT/power supply  
 (3) Version available upon request; for information call our sales department, local agent or representative

## BLOCK DIAGRAM

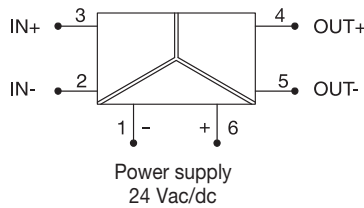

## VERSIONS

**IN: 4...20 mA / OUT: 0...10 V**  
**IN: 4...20 mA / OUT: 0...20 mA**  
**IN: 4...20 mA / OUT: 4...20 mA**

## INPUT TECHNICAL DATA

Input signal  
 Input resistance

## OUTPUT TECHNICAL DATA

Output signal  
 Applicable load

## GENERAL TECHNICAL DATA

Supply voltage  
 Rated current  
 Accuracy  
 Transmission frequency  
 Temperature coefficient  
 Isolation  
 ECM standards  
 Reference Standard  
 Overvoltage category/Pollution degree  
 Protection degree  
 Operating temperature range  
 Connection terminal  
 Housing material  
 Approx. weight  
 Mounting information

## Cat. No. X756536

CWAA 7-0536

## Cat. No. X756537

CWAA 7-0537 (3)

## Cat. No. X756538

CWAA 7-0538

**4...20 mA**  
 100 Ω

**4...20 mA**  
 100 Ω

**4...20 mA**  
 100 Ω

**0...10 V**  
 >1 kΩ

**0...20 mA**  
 <400 Ω

**4...20 mA**  
 <400 Ω

24 Vac/dc (1)  
 ≤ 13 mA ± 10%  
 0.1% @ 23°C FS  
 < 30 Hz  
 0.02% / K FS  
 1.5 kVac / 60 s (2)  
 EN 61000-6-2, EN 61000-6-4  
 IEC 664-1, DIN VDE  
 III / 2  
 IP 20 IEC 529, EN60529  
 -25...+60°C  
 2.5 mm<sup>2</sup> fixed screw type  
 PPE  
 40 g (1.41 oz)  
 vertical on rail adjacent without gap

24 Vac/dc (1)  
 ≤ 13 mA ± 10%  
 0.1% @ 23°C FS  
 < 30 Hz  
 0.02% / K FS  
 1.5 kVac / 60 s (2)  
 EN 61000-6-2, EN 61000-6-4  
 IEC 664-1, DIN VDE  
 III / 2  
 IP 20 IEC 529, EN60529  
 -25...+60°C  
 2.5 mm<sup>2</sup> fixed screw type  
 PPE  
 40 g (1.41 oz)  
 vertical on rail adjacent without gap

24 Vac/dc (1)  
 ≤ 13 mA ± 10%  
 0.1% @ 23°C FS  
 < 30 Hz  
 0.02% / K FS  
 1.5 kVac / 60 s (2)  
 EN 61000-6-2, EN 61000-6-4  
 IEC 664-1, DIN VDE  
 III / 2  
 IP 20 IEC 529, EN60529  
 -25...+60°C  
 2.5 mm<sup>2</sup> fixed screw type  
 PPE  
 40 g (1.41 oz)  
 vertical on rail adjacent without gap

## APPLICATIONS

These converters can be used to convert and isolate the most common standard analog signals; each model is designed for a single input output signal function, and they are the right solution in applications where many modules handling the same signal are used, where they allow a large cost reduction compared with multi function modules. These modules are provided with 3 ways galvanic isolation between input output and supply voltage. If a single signal must provide several output channels it is possible to use many modules connecting their inputs in parallel as long as the signal is voltage, or in series when the signal is current

## MOUNTING ACCESSORIES

Mounting rail type according to IEC60715/TH35-7.5  
 Mounting rail type according to IEC60715/G32  
 Plug-in jumper red  
 (16 poles, 16 A) white  
 blue

## PR/3/AC, PR/3/AC/ZB, PR/3/AS, PR/3/AS/ZB

—  
 CWBK 7-0802 Cat. No. X766802  
 CWBK 7-0803 Cat. No. X766803  
 CWBK 7-0804 Cat. No. X766804

# Passive galvanic isolators

- Do not require power supply
- Suitable for loop powered sensors
- 2 Ways I/O 500 V isolation
- Single and double channel version
- Compact dimension, 6.2 mm pitch

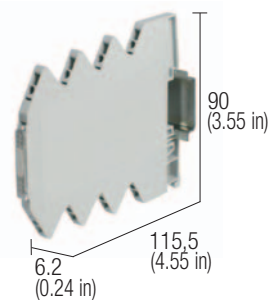
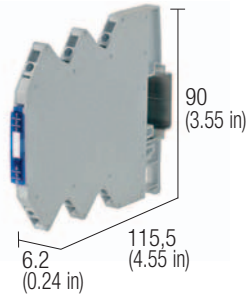

## NOTES

The dimensions includes the DIN clamp.

(1) Input voltage must have a value higher than the value calculated with this formula, where  $R_b$  is load resistance (see pic.1); for calculation refer to the diagram comparing minimum input voltage with output load and wires resistance values; refer to the diagram (see pic. 2) to define if application conditions allow to get full 20 mA output signal

(2) 2-way isolation: IN/OUT

(3) Version available upon request; for information call our sales department, local agent or representative

## BLOCK DIAGRAM

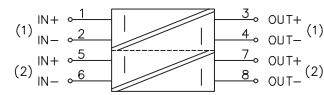
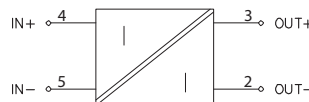

## VERSIONS

Single channel  
Double channel

## INPUT TECHNICAL DATA

Input signal  
Input current  
Input voltage (1)  
Input resistance

Cat. No. X756526

CWPAA 7-0526

Cat. No. X756527

CWPAA 7-0527 (3)

1 channel 0...20 mA, 4...20 mA

—  
2.7 + (20 mA x  $R_b$ )  
100  $\Omega$

2 channels 0...20 mA, 4...20 mA

—  
2.7 + (20 mA x  $R_b$ )  
100  $\Omega$

## OUTPUT TECHNICAL DATA

Output signal  
Applicable load

1 channel 0...20 / 4...20 mA, (max 21 mA)  
<400  $\Omega$  with output current

2 channels 0...20 / 4...20 mA, (max 21 mA)  
<400  $\Omega$  with output current

## GENERAL TECHNICAL DATA

Supply voltage  
Rated current  
Accuracy  
Rise time (10..90%)  
Transmission frequency  
Temperature coefficient  
Isolation  
ECM standards  
Reference Standard  
Overvoltage category/Pollution degree  
Protection degree  
Operating temperature range  
Connection terminal  
Housing material  
Approx. weight  
Mounting information

—  
12 mA  
0.1 FS (23°C)  
10 ms  
30 Hz @ 3 dB  
0.02% FS  
1.5 kVac / 60 s (2)  
EN 61000-6-2, EN 61000-6-4  
IED 664-1, DIN VDE  
III / 2  
IP 20 IEC 529 EN60529  
-25...+60°C  
1.5 mm<sup>2</sup> fixed screw type  
Luranyl  
35 g (1.24 oz)  
vertical on rail adjacent without gap

—  
12 mA  
0.1 FS (23°C)  
10 ms  
30 Hz @ 3 dB  
0.02% FS  
1.5 kVac / 60 s (2)  
EN 61000-6-2, EN 61000-6-4  
IED 664-1, DIN VDE  
III / 2  
IP 20 IEC 529 EN60529  
-25...+60°C  
1.5 mm<sup>2</sup> fixed screw type  
Luranyl  
35 g (1.24 oz)  
vertical on rail adjacent without gap

## MOUNTING ACCESSORIES

Mounting rail type according to IEC60715/TH35-7.5  
Mounting rail type according to IEC60715/G32

Plug-in jumper red  
(16 poles, 16 A) white  
blue

PR/3/AC, PR/3/AC/ZB, PR/3/AS, PR/3/AS/ZB

CWBK 7-0802 Cat. No. X766802  
CWBK 7-0803 Cat. No. X766803  
CWBK 7-0804 Cat. No. X766804

## APPLICATIONS

The passive galvanic isolators can isolate the signal generated by loop powered sensors, where the applied load must have a resistance lower than 400  $\Omega$  20 mA, including the cable resistance; the applied input voltage has to be higher than 2.7 V compared with output voltage (see note 2). If above conditions are satisfied, passive isolators reduce cabling costs and eliminate power supplies thereby saving costs. If above conditions are not satisfied, passive module introduces a signal attenuation.

figure 1

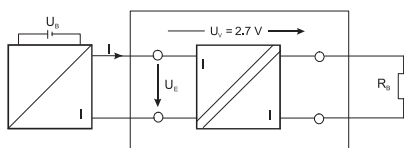
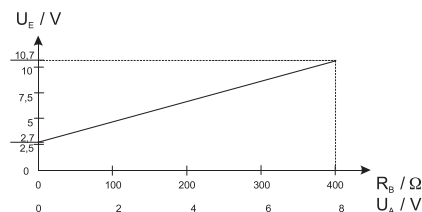

figure 2





# Analogue signal limit value switch

- 3 ways I/O 2.5 kV isolation
- programmable input ranges via dip-switch and customizable via software FDT/DTM
- 2 threshold customizable via software FDT/DTM
- Symple functions programming

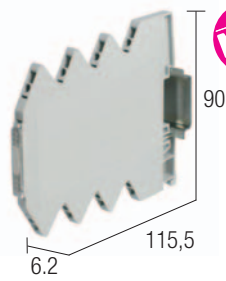

Programming tool X756894



## NOTES

The dimensions includes the DIN clamp.

- (1) Version available upon request; for information call our sales department, local agent or representative
- (2) Input temperature ranges can be set via dip switch and adjustable via FDT/DTM software.  
Output ranges can be set via FDT/DTM software
- (3) 3-way isolation: IN / OUT/ supply

## BLOCK DIAGRAM

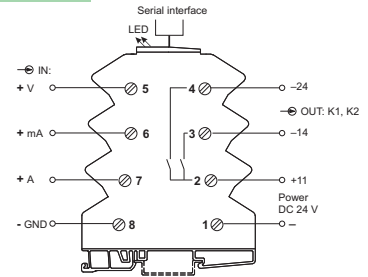

VERSION	Cod. X756360	Cod. X756894	APPLICATIONS
With screw terminals (standard)			CWTPR 7-0360 is an analog signal converter that provides high accuracy measurement and that can be connected to a wide range of analogue sensors. Input range and the output thresholds can be modified with a FDT/DTM software and an USB interface. Are available two normally open contact with solid state relay.
With spring terminals	(1)		
Programming tool	LCONALSFDT (1)		
		LCONZUSB (1)	
INPUT TECHNICAL DATA			
Input signal (1)	-30...+30 V	-50...+50 mA	-5...+5 A
Input resistance	330 kΩ	30 Ω	10 mΩ
Zero / Spam	adjustable via software FDT/DTM		
OUTPUT TECHNICAL DATA			
Threshold regulation	programmable via software FDT/DTM		
Contact type	2 NO contact (solid state relay)		
Max. switching voltage / current	30 Vdc / 100 mA		
Status indication	2 yellow LED		
Operating mode	limit value, window, tendency, inverting and hold function		
GENERAL TECHNICAL DATA			
Supply voltage	24 Vdc (16.8...30 Vdc)		
Rated current	18 mA ± 10% @ 24 Vdc		
Accuracy	0.1% FS		
Data processing	24 Bit		
Linearity error	< 100 ppm FS		
Temperature coefficient	< 100 ppm/°C		
Response time	1...500 ms (adjustable, default 30 ms)		
Isolation	2.5 kVac / 60 s (3)		
EMC Standard	EN 50081-2, EN 50082-2		
Reference Standard	IEC 664-1, DIN VDE		
Overvoltage category/Pollution degree	III / 2		
Protection degree	IP20		
Operating temperature range	-40...+70°C		
Connection terminal	1.5 mm <sup>2</sup> fixed screw type		
Housing material	Noryl UL94V-0		
Approx. weight	600 g		
Mounting information	vertical on rail adjacent without gap		
MOUNTING ACCESSORIES			
Mounting rail type according to IEC60715/TH35-7.5	PR/3/AC, PR/3/AC/ZB, PR/3/AS, PR/3/AS/ZB		
Mounting rail type according to IEC60715/G32	—		
Plug-in jumper (16 poles, 16 A)	red white blue	CWBK 7-0802 cod. X766802 CWBK 7-0803 cod. X766803 CWBK 7-0804 cod. X766804	

# Temperature transducer

- For PT100, PT1000 sensors, thermocouples, potentiometers
- 3 ways I/O 2.5 kV isolation
- 145 programmable input ranges via dip-switch and customizable via software FDT/DTM
- 5 programmable output ranges via dip-switch and customisable via software FDT/DTM
- Compact dimension, 6.2 mm pitch



Programming tool X756894

## NOTES

- The dimensions includes the DIN clamp.
- (1) Version available upon request; for information call our sales department, local agent or representative
  - (2) Input temperature ranges, and output signals, can be set via dip switch, or adjustable via FDT/DTM software.
  - (3) 3-way isolation: IN / OUT/ supply

## BLOCK DIAGRAM

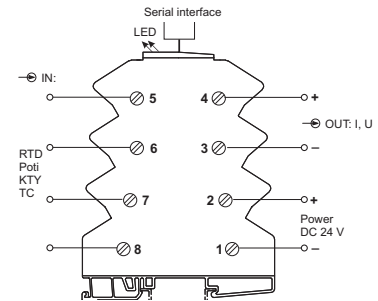
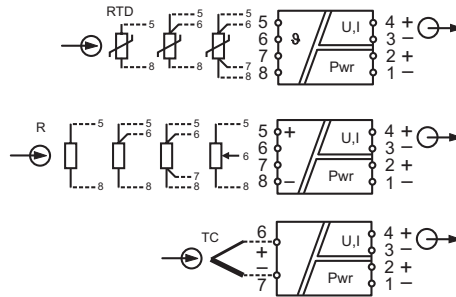

## VERSIONS

With screw terminals (standard)

With spring terminals

Programming tool

## INPUT TECHNICAL DATA

Input signal

Temperature range

## OUTPUT TECHNICAL DATA

Output signal

Applicable load

Display signals

Cod. X756340

Cod. X756894

LCONTADFDT (1)

(1)

LCONZBUSB (1)

PT100, PT1000 sensor  
potenziometer 0...600k $\Omega$   
thermocouple B, C, E, J, K, N, R, S, T type  
-200...+1400°C, according to sensor type (2)

0...10 / -10...+10 V, (max. 10.25 V)  
0...20 / 4...20 mA, (max 21 mA) (2)  
>2 k $\Omega$  with output voltage  
<650  $\Omega$  with output current  
green LED = OK, flashing red LED = error

## APPLICATIONS

CSWTPR 7-0340 is a temperature to analog signal conversion module that provides high accuracy measurement and that can be connected to a wide range of temperature sensors. The module can be used for a temperature range from -200 to + 1.400°C.

With resistive sensors it is possible to select among 2, 3, 4 wire connections. Input and output ranges can be modified with a FDT/DTM software and an USB interface.

## GENERAL TECHNICAL DATA

Supply voltage	24 Vdc (16.8...30 Vdc)
Rated current	18 mA max. @ 24 Vdc
Accuracy	10K/span(K) + 0.2% FS (for RTD) / 10K/span(K) + 0.4% FS (for TE)
Data processing	24 bit
Linearity error	$\pm 0.05\%$ FS - $\pm 0.1\%$ FS (for TE)
Temperature coefficient	<100 ppm/°C
Response time	5...500 ms (regolabile, default 30 ms)
Isolation	2.5 kVac / 60 s (3)
ECM standards	EN 61000-6-2, EN 61000-6-4
Reference Standard	IEC 664-1, DIN VDE
Overvoltage category / Pollution degree	III / 2
Protection degree	IP 20 IEC 529 EN60529
Operating temperature	-40...+70°C
Connection terminal	1.5 mm <sup>2</sup> fixed screw ty'e
Housing material	PPE
Approx. weight	40 g (1.41 oz)
Mounting information	vertical on rail adjacent without gap

## MOUNTING ACCESSORIES

Mounting rail type according to IEC60715/TH35-7.5	PR/3/AC, PR/3/AC/ZB, PR/3/AS, PR/3/AS/ZB
Mounting rail type according to IEC60715/G32	—
Plug-in jumper	red CWBK 7-0802 cod. X766802 white CWBK 7-0803 cod. X766803 blue CWBK 7-0804 cod. X766804

Range*	S1			S2						
Start	7	8	12	End	3	4	5	6	7	8
-200°C	●	●	●	0°C	●	●	●	●	●	●
-150°C	●	●	●	50°C	●	●	●	●	●	●
-100°C	●	●	●	100°C	●	●	●	●	●	●
-50°C	●	●	●	150°C	●	●	●	●	●	●
0°C	●	●	●	200°C	●	●	●	●	●	●
				250°C	●	●	●	●	●	●
				300°C	●	●	●	●	●	●
				350°C	●	●	●	●	●	●
				400°C	●	●	●	●	●	●
				450°C	●	●	●	●	●	●
				500°C	●	●	●	●	●	●
				550°C	●	●	●	●	●	●
				600°C	●	●	●	●	●	●
				650°C	●	●	●	●	●	●
				700°C	●	●	●	●	●	●
				750°C	●	●	●	●	●	●
				800°C	●	●	●	●	●	●
				850°C	●	●	●	●	●	●
				900°C	●	●	●	●	●	●
				950°C	●	●	●	●	●	●
				1000°C	●	●	●	●	●	●
				1050°C	●	●	●	●	●	●
				1100°C	●	●	●	●	●	●
				1150°C	●	●	●	●	●	●
				1200°C	●	●	●	●	●	●
				1250°C	●	●	●	●	●	●
				1300°C	●	●	●	●	●	●
				1350°C	●	●	●	●	●	●
				1400°C	●	●	●	●	●	●

● → Switch On

S1-S2 1-8 off:  
FDT/DTM

# Temperature limit value switch

- For PT100, PT1000 sensors, thermocouples, potentiometers
- 3 ways I/O 2.5 kV isolation
- 145 programmable input ranges via dip-switch and customizable via software FDT/DTM™
- 2 threshold customizable via software FDT/DTM
- Compact dimension, 6.2 mm pitch



**NEW**  
cabur



Programming tool X756894

## NOTES

- The dimensions includes the DIN clamp.
- (1) Version available upon request; for information call our sales department, local agent or representative
  - (2) Input temperature ranges can be set via dip switch and adjustable via FDT/DTM software. Output ranges can be set via FDT/DTM software
  - (3) 3-way isolation: IN/OUT/power supply

## BLOCK DIAGRAM

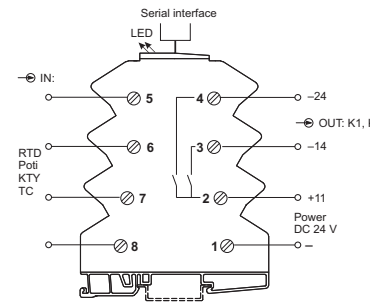
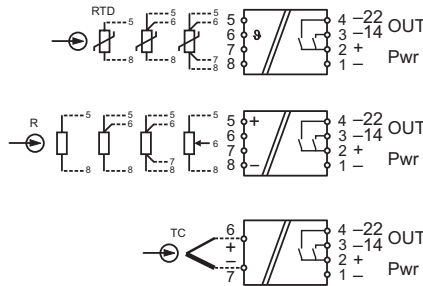

## VERSIONS

With screw terminals (standard)

With spring terminals

Programming tool

## INPUT TECHNICAL DATA

Input signal

Temperature range

## OUTPUT TECHNICAL DATA

Threshold regulation

Contact type

Max. switching voltage / current

Status indication

Operating mode

## GENERAL TECHNICAL DATA

Supply voltage

Rated current

Accuracy

Data processing

Linearity error

Temperature coefficient

Response time

Isolation

ECM standards

Reference Standard

Overvoltage category / Pollution degree

Protection degree

Operating temperature

Connection terminal

Housing material

Approx. weight

Mounting information

## MOUNTING ACCESSORIES

Mounting rail type according to IEC60715/TH35-7.5

Mounting rail type according to IEC60715/G32

Plug-in jumper

red

white

blue

Cod. X756370

Cod. X756894

LCONTLSFDT (1)

(1)

LCONZBUSB (1)

PT100, PT1000 sensor  
potenziometer 0...600kΩ  
thermocouple B, C, E, J, K, N, R, S, T type  
-200...+1400°C, according to sensor type (2)

programmable via software FDT/DTM

2 NO contact (solid state relay)

30 Vdc / 100 mA

2 yellow LED

limit value, window, tendency, inverting and hold function

24 Vdc (16.8...30 Vdc)

18 mA max. @ 24 Vdc

10K/span(K) + 0.2% FS (for RTD) / 10K/span(K) + 0.4% FS (for TE)

24 bit

±0.05% FS (for RTD and potentiometer) / ±0.1% FS (for TE)

<100 ppm/°C

5...500 ms (regolabile, default 30 ms)

2.5 kVac / 60 s (3)

EN 61000-6-2, EN 61000-6-4

IEC 664-1, DIN VDE

III / 2

IP 20 IEC 529 EN60529

-40...+70°C

1.5 mm<sup>2</sup> fixed screw type

PPE

40 g (1.41 oz)

vertical on rail adjacent without gap

PR/3/AC, PR/3/AC/ZB, PR/3/AS, PR/3/AS/ZB

CWBK 7-0802 cod. X766802

CWBK 7-0803 cod. X766803

CWBK 7-0804 cod. X766804

## APPLICATIONS

CWTPR 7-0370 is a temperature to analogue signal conversion module that provides high accuracy measurement and that can be connected to a wide range of temperature sensors. The module can be used for a temperature range from -200 to +1.400°C. With resistive sensors it is possible to select among 2, 3, 4 wire connections.

Input range and the output thresholds can be modified with a FDT/DTM software and an USB interface.

Two normally open contact with solid state relay are available.

# Temperature transducer

- Converters for PT100 sensors
- 3 ways galvanic isolation
- 8 programmable input range
- 3 programmable output range
- Simple programming
- Version with 24-240 Vac/dc supply voltage

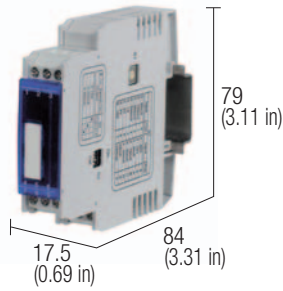

## NOTES

The dimensions includes the DIN clamp.

- (1) Adjustable via rotary-switch
- (2) Adjustable via dip-switch
- (3) They can also be used with 2 wire PT100 sensor, connecting the terminals 1 and 4
- (4) range 16.8...30 Vdc / 19.2...28.8 Vac
- (5) range 16.8...264 Vdc / 19.2...264 Vac
- (6) 3-way isolation: IN/OUT/power supply
- (7) Version available upon request; for information call our sales department, local agent or representative

## BLOCK DIAGRAM

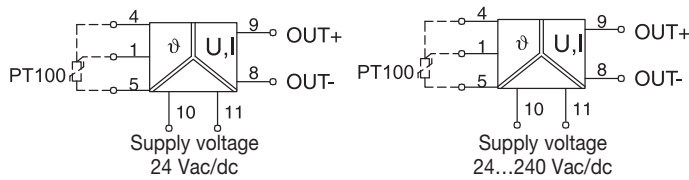

## VERSIONS

- 24 Vac/dc supply voltage
- 24-240 Vac/dc supply voltage

## INPUT TECHNICAL DATA

Input signal  
Temperature range (1)

Supply current

## OUTPUT TECHNICAL DATA

Output signal (2)

Applicable load

## GENERAL TECHNICAL DATA

Supply voltage  
Rated current  
Accuracy  
Transmission frequency  
Temperature coefficient  
Isolation  
ECM standards  
Reference Standard  
Overvoltage category/Pollution degree  
Protection degree  
Operating temperature range  
Connection terminal  
Housing material  
Approx. weight  
Mounting information

## Cat. No. X756816

### CWPT 6-0816

PT100 3 wires (3)  
-50...+50°C (-58...+122°F)  
-50...+100°C (-58...+212°F)  
-50...+150°C (-58...+302°F)  
0...+100°C (+32...+212°F)  
0...+150°C (+32...+302°F)  
0...+200°C (+32...+392°F)  
0...+300°C (+32...+572°F)  
0...+400°C (+32...+752°F)  
0.5 mA

## Cat. No. X756817

### CWPT 6-0817 (7)

PT100 3 wires (3)  
-50...+50°C (-58...+122°F)  
-50...+100°C (-58...+212°F)  
-50...+150°C (-58...+302°F)  
0...+100°C (+32...+212°F)  
0...+150°C (+32...+302°F)  
0...+200°C (+32...+392°F)  
0...+300°C (+32...+572°F)  
0...+400°C (+32...+752°F)  
0.5 mA

## APPLICATIONS

The modules convert and isolate signals generated by 3 wire / 2 wire PT100 (RTD) sensors into analogue signals; the module can be set into 8 temperature ranges and for up to 3 most important analogue ranges. Set up is easily achieved by setting a dip-switch on one side of the module. The modules provide input and output isolation, assuring high signal accuracy, and can be used with isolated and not isolated sensors. Two wire sensors can be used by connecting a jumper wire between 1 and 4 terminal blocks.

## MOUNTING ACCESSORIES

Mounting rail type according to IEC60715/TH35-7.5  
Mounting rail type according to IEC60715/G32  
Plug-in jumper  
(16 poles, 16 A)

red  
white  
blue

## PR/3/AC, PR/3/AC/ZB, PR/3/AS, PR/3/AS/ZB

—  
—  
—  
—

# Temperature transducer

- Converters for sensors with thermocouples J and K type
- 3 ways galvanic isolation
- 8 programmable input range
- 3 programmable output range
- Simple programming

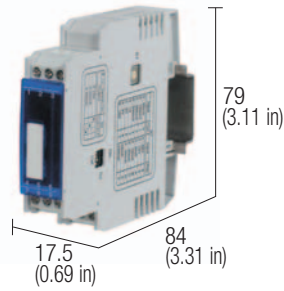

## NOTES

The dimensions includes the DIN clamp.

- (1) Adjustable via rotary-switch
- (2) Adjustable via dip-switch
- (3) range 16.8...30 Vdc / 19.2...28.8 Vac
- (4) range 16.8...264 Vdc / 19.2...264 Vac
- (5) \*3-way isolation: IN/OUT/power supply
- (7) Version available upon request; for information call our sales department, local agent or representative

## BLOCK DIAGRAM

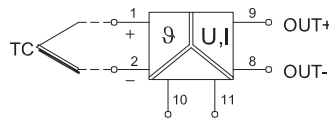

Supply voltage  
24 Vac/dc

Supply voltage  
24...240 Vac/dc

## VERSIONS

**24 Vac/dc supply voltage**

**24-240 Vac/dc supply voltage**

**Cat. No. X756844**

**CWTH 6-0844**

**Cod. X756847**

**CWTH 6-0847 (7)**

## INPUT TECHNICAL DATA

Input signal

Temperature range (1)

thermocouples FeCuNi (J type) e NiCrNi (K type) according to DIN/IEC584-1

-50...+200°C (-58...+392°F)  
 -50...+350°C (-58...+662°F)  
 0...+200°C (+32...+392°F)  
 0...+400°C (+32...+752°F)  
 0...+600°C (+32...+1112°F)  
 0...+800°C (+32...+1472°F)  
 0...+1000°C (+32...+1832°F)  
 0...+1200°C (+32...+2192°F)

termocoppia FeCuNi (tipo J) e NiCrNi (tipo K) conformi a DIN/IEC584-1

-50...+200°C (-58...+392°F)  
 -50...+350°C (-58...+662°F)  
 0...+200°C (+32...+392°F)  
 0...+400°C (+32...+752°F)  
 0...+600°C (+32...+1112°F)  
 0...+800°C (+32...+1472°F)  
 0...+1000°C (+32...+1832°F)  
 0...+1200°C (+32...+2192°F)

Supply current

## OUTPUT TECHNICAL DATA

Output signal (2)

Applicable load

0...10 V  
 0...20 / 4...20 mA  
 >1 kΩ with output voltage,  
 <400 Ω with output current

0...10 V  
 0...20 / 4...20 mA  
 >1 kΩ con uscita in tensione,  
 <400 Ω con uscita in corrente

## GENERAL TECHNICAL DATA

Supply voltage

Rated current

Accuracy

Trasmission frequency

Temperature coefficient

Isolation

ECM standards

Reference Standard

Overtoltage category/Pollution degree

Protection degree

Operating temperature range

Connection terminal

Housing material

Approx. weight

Mounting information

24 Vac/dc (3)

≤ 35 mA ± 10% @ 24 Vdc

<0.5% FS

<30 Hz

0.015% / K FS

1.5 kVac / 60 s (5)

EN 50081-2, EN 50082-2

IEC 664-1, DIN VDE

III / 2

IP20

-20...+60°C

2.5 mm<sup>2</sup> fixed screw type

Noryl UL94V-0

65 g (2.29 oz)

vertical on rail adjacent without gap

24-240 Vac/dc (4)

≤ 35 mA ± 10% @ 24 Vdc

<0.5% FS

<30 Hz

0.015% / K FS

4 kVac / 60 s (5)

EN 50081-2, EN 50082-2

IEC 664-1, DIN VDE

III / 2

IP20

-20...+60°C

morsetti a vite 2.5 mm<sup>2</sup>, fissi

Noryl UL94V-0

75 g

verticali su guida, affiancati

## MOUNTING ACCESSORIES

Mounting rail type according to IEC60715/TH35-7.5

Mounting rail type according to IEC60715/G32

Plug-in jumper

(16 poles, 16 A)

red

white

blue

**PR/3/AC, PR/3/AC/ZB, PR/3/AS, PR/3/AS/ZB**

—

—

—

—



# Current limit value switch

- For AC current measure
- Adjustable threshold value
- Versions with transistor or relay output
- IN/OUT 3 kV isolation

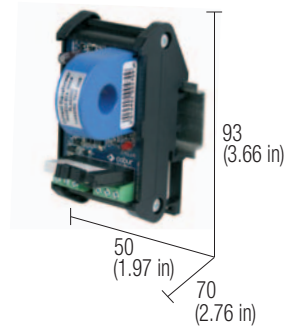

## NOTES

The dimensions includes the terminal blocks and the DIN clamp.  
 (1) Isolation referred to conductor being measured, not isolated (naked) and in contact with the wall of the toroid. By using isolated conductors, the isolation value of the conductor is added to isolation of the module.

## BLOCK DIAGRAM

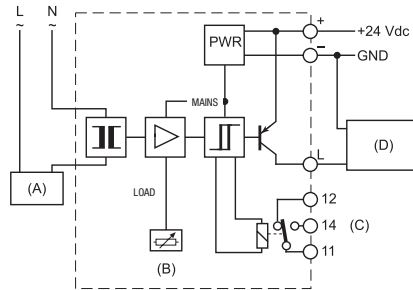

- (A) AC load
  - (B) Threshold
  - (C) Output with SPDT contact
  - (D) Digital input drive by transistor
- Power supply  
24 Vac/dc

## VERSIONS

**Cod. XCCIS2**  
**CCIS-2**

## APPLICATIONS

This module converts a current flowing through circuit into a threshold that can be adjusted by the potentiometer; when the current reaches the threshold value, the relay or the transistor switches; the wire must be feed through the hole of the current sensor for current detection.

## INPUT TECHNICAL DATA

Max. measured current	50 A (AC)
Max. measured voltage	600 Vac (1)
Frequency	50...60 Hz
Sensor's hole diameter	Ø 13 mm

## OUTPUT TECHNICAL DATA

Threshold regulation	2...40 A
Threshold hysteresis	± 10%
Max. output current	100 mA open collector PNP
Output status	"high" 24 V (closed) with I < threshold "low" 0 V (open) with I > threshold
Response time	20 ms

## GENERAL TECHNICAL DATA

Supply voltage	24 Vdc ± 10%
Max rated current	100 mA
Operating temperature range	0...60°C
Input/output isolation	> 3 kVac /60 s
Connection terminal	2.5 mm <sup>2</sup> fixed screw type (14 AWG)
Housing material	polyamide UL94V-03
Approx. weight	100 g (3.53 oz)
Mounting information	vertical on rail adjacent without gap

## MOUNTING ACCESSORIES

Mounting rail type according to IEC60715/TH35-7.5	
Mounting rail type according to IEC60715/G32	
Plug-in jumper	red
(16 poles, 16 A)	white
	blue

## PR/3/AC, PR/3/AS

<b>PR/DIN/AC, PR/DIN/AS, PR/DIN/AL</b>	—
	—
	—

# Current transducers

- For AC/DC current measurements
- Protected against transients
- Power supplied LED
- 3 output signals available

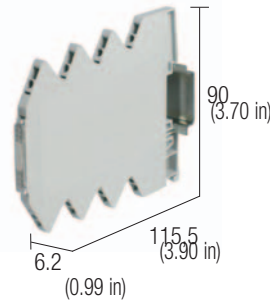

## NOTES

The dimensions includes the terminal blocks and the DIN clamp.

(1) Do not connect directly to a 400 V line

## BLOCK DIAGRAM

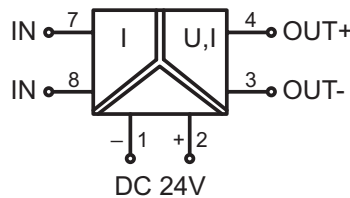

## VERSIONS

0...1 A input

0...5 A input

0...10 A input

Cod. X756540	Cod. X756541	Cod. X756542
WAA 7-0540	WAA 7-0541	WAA 7-0542

## INPUT TECHNICAL DATA

Input signal	0...1 A AC/DC	0...5 A AC/DC	0...10 A AC/DC
Max. input voltage	400 V (1)	400 V (1)	400 V (1)
Current wire connection	1.5 mm <sup>2</sup> screw type	1.5 mm <sup>2</sup> screw type	1.5 mm <sup>2</sup> screw type

## VOLTAGE

0...10 V	0...20 mA / 4...20 mA
11 V	21 mA
>1 k $\Omega$	<400 $\Omega$

## OUTPUT TECHNICAL DATA

Output signal	0...10 V	0...20 mA / 4...20 mA
Max. output signal	11 V	21 mA
Applicable load	>1 k $\Omega$	<400 $\Omega$

## CURRENT

0...10 V	0...20 mA / 4...20 mA
11 V	21 mA
>1 k $\Omega$	<400 $\Omega$

## GENERAL TECHNICAL DATA

Supply voltage	24 Vdc (16.8...30 Vdc)	24 Vdc (16.8...30 Vdc)	24 Vdc (16.8...30 Vdc)
Rated current	13 mA	13 mA	13 mA
Operating temperature	-25...+60°C	-25...+60°C	-25...+60°C
Linearity error	< 0.1% FS (23°C)	< 0.1% FS (23°C)	< 0.1% FS (23°C)
Offset error	< 0.5% FS (23°C)	< 0.5% FS (23°C)	< 0.5% FS (23°C)
Temperature coefficient	< 150 ppm / K FS	< 150 ppm / K FS	< 150 ppm / K FS
Response time	150 ms	150 ms	150 ms
Protection degree	IP20	IP20	IP20
Connection terminal	1.5 mm <sup>2</sup> screw type	1.5 mm <sup>2</sup> screw type	1.5 mm <sup>2</sup> screw type
Approx. weight	55 g (1.94 oz)	55 g (1.94 oz)	55 g (1.94 oz)
Mounting information	vertical on rail adjacent without gap	vertical on rail adjacent without gap	vertical on rail adjacent without gap

## GENERAL TECHNICAL DATA

Supply voltage	24 Vdc (16.8...30 Vdc)	24 Vdc (16.8...30 Vdc)	24 Vdc (16.8...30 Vdc)
Rated current	13 mA	13 mA	13 mA
Operating temperature	-25...+60°C	-25...+60°C	-25...+60°C
Linearity error	< 0.1% FS (23°C)	< 0.1% FS (23°C)	< 0.1% FS (23°C)
Offset error	< 0.5% FS (23°C)	< 0.5% FS (23°C)	< 0.5% FS (23°C)
Temperature coefficient	< 150 ppm / K FS	< 150 ppm / K FS	< 150 ppm / K FS
Response time	150 ms	150 ms	150 ms
Protection degree	IP20	IP20	IP20
Connection terminal	1.5 mm <sup>2</sup> screw type	1.5 mm <sup>2</sup> screw type	1.5 mm <sup>2</sup> screw type
Approx. weight	55 g (1.94 oz)	55 g (1.94 oz)	55 g (1.94 oz)
Mounting information	vertical on rail adjacent without gap	vertical on rail adjacent without gap	vertical on rail adjacent without gap

## MOUNTING ACCESSORIES

Mounting rail type according to IEC60715/TH35-7.5	
Mounting rail type according to IEC60715/G32	
Plug-in jumper (16 poles, 16 A)	red white blue

## PR/3/AC, PR/3/AC/ZB, PR/3/AS, PR/3/AS/ZB

CWBK 7-0802	cod. X766802
CWBK 7-0803	cod. X766803
CWBK 7-0804	cod. X766804

## APPLICATIONS

Through a "HALL" sensor they grant AC/DC current measurements.

The presence of current in a circuit indicates not only that power is supplied but also that the circuit is closed and the load connected and active.

It's also possible to know the work conditions of the circuit.

The module guarantees galvanic isolation between the current conductor and the analogue.

● → Switch On		S1			
Input	Output	1	2	3	4
0-1A	0-10V				
0-1A	0-20mA	●			
0-1A	4-20mA		●		

Range WAA7-0540

● → Switch On		S1			
Input	Output	1	2	3	4
0-5A	0-10V				
0-5A	0-20mA	●			
0-5A	4-20mA		●		

Range WAA7-0541

● → Switch On		S1			
Input	Output	1	2	3	4
0-10A	0-10V				
0-10A	0-20mA	●			
0-10A	4-20mA		●		

Range WAA7-0542

# Current transducers

- For AC/DC current measurements
- Protected against transients
- Power supplied LED
- 3 output signals available

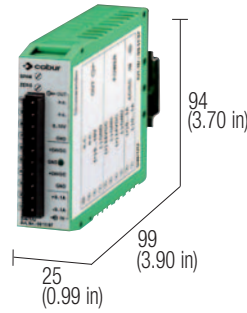

## NOTES

The dimensions includes the terminal blocks and the DIN clamp.

## BLOCK DIAGRAM

Article available until sell-out  
 XW000928 will be replaced by **X756540**  
 XW000929 will be replaced by **X756541**  
 XW000930 will be replaced by **X756542**

## VERSIONS

- 0...1 A input
- 0...5 A input
- 0...10 A input

Cat. No. XW000928	Cat. No. XW000929	Cat. No. XW000930
SW01VA	SW05VA	SW10VA

## APPLICATIONS

In 99 mm depth measure is included the space occupied by the terminal block provided with the product. Through a "HALL" sensor they grant AC/DC current measurements. The presence of current in a circuit indicates not only that power is supplied but also that the circuit is closed and the load connected and active. It's also possible to know the work conditions of the circuit. The module guarantees galvanic isolation between the current conductor and the analogue output and, if not connected in series to the controlled current, cannot be damaged by power surges or short circuits.

## INPUT TECHNICAL DATA

Input signal	0...1 A AC/DC	0...5 A AC/DC	0...10 A AC/DC
Max. input voltage	380 V	380 V	380 V
Current wire connection	2.5 mm <sup>2</sup> pluggable screw type	2.5 mm <sup>2</sup> pluggable screw type	2.5 mm <sup>2</sup> pluggable screw type

VOLTAGE		CURRENT	
Output signal	0...10 V	0...20 mA / 4...20 mA	
Max. output signal	11 V	22 mA	
Applicable load	>2 kΩ	<500 Ω	

## OUTPUT TECHNICAL DATA

## GENERAL TECHNICAL DATA

Supply voltage	24 Vdc ± 10%	24 Vdc ± 10%	24 Vdc ± 10%
Rated current	60 mA	60 mA	60 mA
Operating temperature	0...55°C	0...55°C	0...55°C
Linearity error	< 0.5%	< 0.5%	< 0.5%
Offset error	< 0.5%	< 0.5%	< 0.5%
Amplification error	< 0.2%	< 0.2%	< 0.2%
Temperature coefficient	< 0.02%/K	< 0.02%/K	< 0.02%/K
Surge immunity	200 V	200 V	200 V
Response time	10 mS	10 mS	10 mS
Protection degree	IP20	IP20	IP20
Connection terminal	2.5 mm <sup>2</sup> pluggable screw type	2.5 mm <sup>2</sup> pluggable screw type	2.5 mm <sup>2</sup> pluggable screw type
Approx. weight	100 g (3.53 oz)	100 g (3.53 oz)	100 g (3.53 oz)
Mounting information	vertical on rail adjacent without gap	vertical on rail adjacent without gap	vertical on rail adjacent without gap

## MOUNTING ACCESSORIES

Mounting rail type according to IEC60715/TH35-7.5	
Mounting rail type according to IEC60715/G32	
Plug-in jumper (16 poles, 16 A)	red white blue

<b>PR/3/AC, PR/3/AC/ZB, PR/3/AS, PR/3/AS/ZB</b>	— — — —
---	------------------

# Current transducers

- For AC/DC current measurements
- Protected against transients
- Power supplied LED
- 3 output signals available

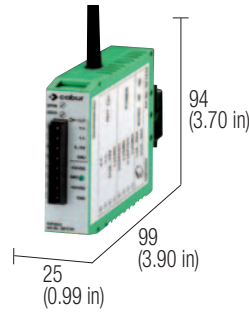

Article available until sell-out



## NOTES

The dimensions includes the terminal blocks and the DIN clamp.

## BLOCK DIAGRAM

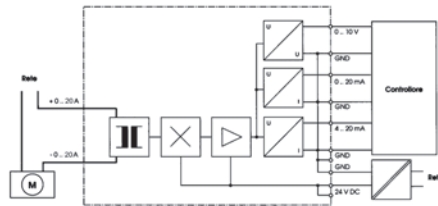

VERSIONS
0...20 A input
0...50 A input

Cat. No. XW000931
SW20VA

Cat. No. XW000932
SW50VA

## APPLICATIONS

In 99 mm depth measure is included the space occupied by the terminal block provided with the product.

They allow the user to measure AC/DC currents by an "HALL" sensor. The presence of current in a circuit indicates not only that power is supplied but also that the circuit is closed and the load connected and active. It is also possible to know the working conditions of the controlled circuit.

The module guarantees galvanic isolation between the current conductor and the analogue output and, if not connected in series to the controlled current, cannot be damaged by power surges or short circuits.

INPUT TECHNICAL DATA
Input signal
Max. input voltage
Current wire connection

0...20 A AC/DC
380 V
Ø 8 mm

0...50 A AC/DC
380 V
Ø 8 mm

OUTPUT TECHNICAL DATA
Output signal
Max. output signal
Applicable load

VOLTAGE
0...10 V
11 V
>2 kΩ

CURRENT
0...20 mA / 4...20 mA
22 mA
<500 Ω

GENERAL TECHNICAL DATA
Supply voltage
Rated current
Operating temperature
Linearity error
Offset error
Amplification error
Temperature coefficient
Surge immunity
Response time
Protection degree
Connection terminal
Approx. weight
Mounting information

24 Vdc ± 10%
60 mA
0...55°C
< 0.5%
< 0.5%
< 0.2%
< 0.02%/K
200 V
10 mS
IP20
2.5 mm² pluggable screw type (14 AWG)
100 g (3.53 oz)
vertical on rail adjacent without gap

24 Vdc ± 10%
60 mA
0...55°C
< 0.5%
< 0.5%
< 0.2%
< 0.02%/K
200 V
10 mS
IP20
2.5 mm² pluggable screw type (14 AWG)
100 g (3.53 oz)
vertical on rail adjacent without gap

## MOUNTING ACCESSORIES

Mounting rail type according to IEC60715/TH35	
Mounting rail type according to IEC60715/G32	
Plug-in jumper	red
(16 poles, 16 A)	white
	blue

PR/3/AC, PR/3/AS
PR/DIN/AC, PR/DIN/AS, PR/DIN/AL
—
—
—

# Frequency signal converter

- Adjustable frequency range 0...28.8 KHz
- 3 programmable analogue signal output ranges
- 3 ways I/O 2.5 kV isolation

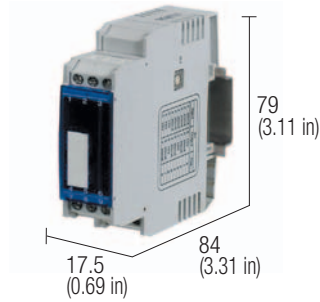

## NOTES

The dimensions includes the terminal blocks and the DIN clamp.

- (1) range 16.8...30 Vdc / 19.2...28.8 Vac  
 (2) 3-way isolation: IN/OUT/power supply

## BLOCK DIAGRAM

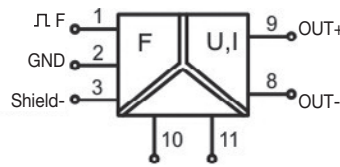

AC/DC 24V

## VERSIONS

Cat. No. X756524  
**CWNFA 6-0524**

## INPUT TECHNICAL DATA

Input signal (range)	0...28.8 kHz adjustable via DIP switch
Input signal (type)	AC/DC 0.6...30 Vpp
Input resistance	50 kΩ
Hysteresis	0.5 Vpp or 5 Vpp adjustable via DIP switch

0...28.8 kHz adjustable via DIP switch
AC/DC 0.6...30 Vpp
50 kΩ
0.5 Vpp or 5 Vpp adjustable via DIP switch

## OUTPUT TECHNICAL DATA

Output signal	0...10 V, (max. 10.6 V)
Applicable load	0...20 / 4...20 mA, (max 21 mA) >1 kΩ with output voltage <400 Ω with output current
Ripple	< 5 mVeff

0...10 V, (max. 10.6 V)
0...20 / 4...20 mA, (max 21 mA) >1 kΩ with output voltage <400 Ω with output current
< 5 mVeff

## GENERAL TECHNICAL DATA

Supply voltage	24 Vac/dc (1)
Rated current	20 mA
Accuracy	0.1 FS (23°C)
Linearity error	0.02%
Ripple	0.1%
Setting time (accuracy 1%)	200 ms
Temperature coefficient	70 ppm/K
Isolation	1.5 kVac / 60 s (2)
ECM standards	EN 61000-6-2, EN 61000-6-4
Reference Standard	IED 664-1, DIN VDE
Overvoltage category	III
Pollution degree	2
Protection degree	IP 20 IEC 529 EN60529
Operating temperature range	-25...+60°C
Connection terminal	1.5 mm <sup>2</sup> fixed screw type
Housing material	PPE
Approx. weight	70 g (2.47 oz)
Mounting information	vertical on rail adjacent without gap

24 Vac/dc (1)
20 mA
0.1 FS (23°C)
0.02%
0.1%
200 ms
70 ppm/K
1.5 kVac / 60 s (2)
EN 61000-6-2, EN 61000-6-4
IED 664-1, DIN VDE
III
2
IP 20 IEC 529 EN60529
-25...+60°C
1.5 mm <sup>2</sup> fixed screw type
PPE
70 g (2.47 oz)
vertical on rail adjacent without gap

## MOUNTING ACCESSORIES

Mounting rail type according to IEC60715/TH35-7.5	—
Mounting rail type according to IEC60715/G32	—
Plug-in jumper	red white blue

<b>PR/3/AC, PR/3/AC/ZB, PR/3/AS, PR/3/AS/ZB</b>	—
—	—
—	—
—	—

## APPLICATIONS

This module is used to convert a frequency signal, with either sinusoidal or square waveform, into a standard analogue signal (eg. 0...10 V, 0..20 mA, 4...20 mA). A microprocessor provides a high resolution, high stability and accuracy output signal and a dip switch gives the possibility to select a calibrated range of frequency measurement from 0 ... 100 Hz up to 0...28.8 kHz.

S2 ● → Switch On														
Range*	1	2	3	4	5	6	8	Range*	1	2	3	4	5	6
0-100Hz	●	●	●	●	●	●	●	0-5kHz	●	●	●	●	●	●
0-200Hz	●	●	●	●	●	●	●	0-6kHz	●	●	●	●	●	●
0-250Hz	●	●	●	●	●	●	●	0-8kHz	●	●	●	●	●	●
0-400Hz	●	●	●	●	●	●	●	0-10kHz	●	●	●	●	●	●
0-500Hz	●	●	●	●	●	●	●	0-12kHz	●	●	●	●	●	●
0-750Hz	●	●	●	●	●	●	●	0-16kHz	●	●	●	●	●	●
0-1kHz	●	●	●	●	●	●	●	0-20kHz	●	●	●	●	●	●
0-1.5kHz	●	●	●	●	●	●	●	0-24kHz	●	●	●	●	●	●
0-2kHz	●	●	●	●	●	●	●	0-28.8kHz	●	●	●	●	●	●
0-2.5kHz	●	●	●	●	●	●	●							
0-3kHz	●	●	●	●	●	●	●							
0-4kHz	●	●	●	●	●	●	●							
Hysteresis								0.5Vpp						
								5Vpp	●					

● → Switch On	S1		
Output	1	2	3
0-10V	●		
0-20mA		●	
4-20mA			●



# Auxiliary supply output for sensors and potentiometers

- Stabilized switching converter
- IN 16.8...20 Vdc / 9...11 Vdc 60 mA
- Suitable to feed potentiometers and sensors

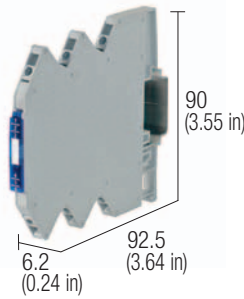

## NOTES

The dimensions includes the DIN clamp.  
(1) range 16.8...30 Vdc

## BLOCK DIAGRAM

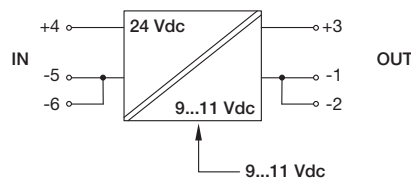

## EXAMPLE

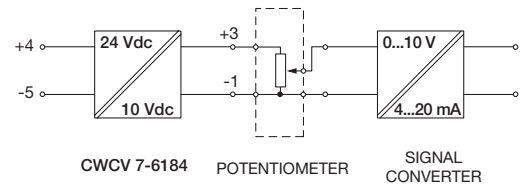

## VERSIONS

- With screw connection (standard)
- With spring connection

## Cat. No. X766184

CWCV 7-6184

## INPUT TECHNICAL DATA

Rated voltage	24 Vdc (1)
Current @ Iout max.	30 mA @ 10 Vdc
Protection fuse	T 1 A (external)

Rated voltage	24 Vdc (1)
Current @ Iout max.	30 mA @ 10 Vdc
Protection fuse	T 1 A (external)

## OUTPUT TECHNICAL DATA

Voltage	10 Vdc (9...11 Vdc adjustable)
Maximum current	60 mA
Continuous current	60 mA
Load regulation	< 1%
Ripple @ rated U-I output	≤ 50 mVpp
Overload / short circuit protection	si
Output signal	yellow LED Power OK
Parallel connection	possible with external diode

Voltage	10 Vdc (9...11 Vdc adjustable)
Maximum current	60 mA
Continuous current	60 mA
Load regulation	< 1%
Ripple @ rated U-I output	≤ 50 mVpp
Overload / short circuit protection	si
Output signal	yellow LED Power OK
Parallel connection	possible with external diode

## GENERAL TECHNICAL DATA

Operating temperature range	-25...+60°C
Input/output isolation	50 Vac / 60 s
Protection degree	IP 20 IEC529, EN60529
EMC Standards	EN 50081-1, EN 50082-2, EN 61000-3-2
Surge immunity	EN61000-4-2, EN61000-4-4
Connection terminal	1.5 mm <sup>2</sup> screw type / 1.5 mm <sup>2</sup> spring type (16 AWG)
Housing material	Noryl UL94V-0
Approx. weight	35 g (1.24 oz)
Mounting information	vertical on rail adjacent without gap

Operating temperature range	-25...+60°C
Input/output isolation	50 Vac / 60 s
Protection degree	IP 20 IEC529, EN60529
EMC Standards	EN 50081-1, EN 50082-2, EN 61000-3-2
Surge immunity	EN61000-4-2, EN61000-4-4
Connection terminal	1.5 mm <sup>2</sup> screw type / 1.5 mm <sup>2</sup> spring type (16 AWG)
Housing material	Noryl UL94V-0
Approx. weight	35 g (1.24 oz)
Mounting information	vertical on rail adjacent without gap

## MOUNTING ACCESSORIES

Mounting rail type according to IEC60715/TH35-7.5	
Mounting rail type according to IEC60715/G32	
Plug-in jumper	red
	white
	blue

## PR/3/AC, PR/3/AC/ZB, PR/3/AS, PR/3/AS/ZB

CWBK 7-0802	Cat. No. X766802
CWBK 7-0803	Cat. No. X766803
CWBK 7-0804	Cat. No. X766804

## APPLICATIONS

For the highest accuracy of electronic measurements in process control and automation systems, a stable supply source is required to feed reference voltages. Accuracy of position sensors, such as linear or rotary potentiometers, depends greatly on the stability and accuracy of the DC supply of the sensor. For this reason our modules are provided with a calibrated DC output dedicated to feed the sensor for the highest accuracy, and this feature also helps to save space and the cost of an external DC supply source.

# NPN and PNP signal polarity inverter

- Converts a NPN sensor in a PNP sensor and vice versa
- Compact design

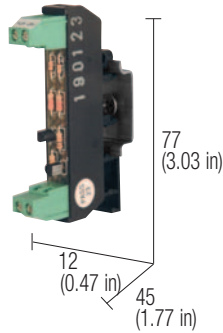

## NOTES

The dimensions includes the terminal blocks and the DIN clamp.  
(1) range 17...30 Vdc

## BLOCK DIAGRAM

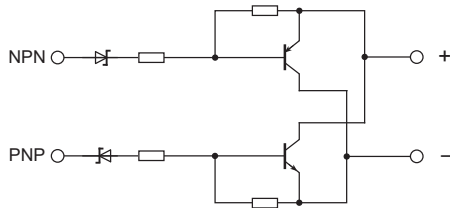

## VERSIONS

Cat. No. XNPNPNP  
CI-NPN/PNP

## INPUT TECHNICAL DATA

Input voltage	24 Vdc (1)
Max. current	200 mA
Max. frequency	120 kHz

## GENERAL TECHNICAL DATA

OFF state current	—
ECM standards	EN 61000-6-2, EN 61000-6-4
Reference Standard	IEC 664-1, DIN VDE
Overvoltage category	II
Pollution degree	2
Protection degree	IP 20 IEC 529 EN60529
Operating temperature range	0...55°C
Connection terminal	morsetti a vite 2.5 mm <sup>2</sup> fissi
Housing material	Poliammide UL94V-0
Approx. weight	20 g (0.71 oz)
Mounting information	vertical on rail adjacent without gap

## MOUNTING ACCESSORIES

Mounting rail type according to IEC60715/TH35-7.5  
Mounting rail type according to IEC60715/G32

PR/3/AC, PR/3/AS  
PR/DIN/AC - PR/DIN/AS - PR/DIN/AL

Plug-in jumper  
red  
white  
blue

## EXAMPLE

### Conversion from PNP to NPN

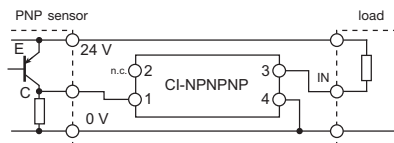

### Conversion from NPN to PNP

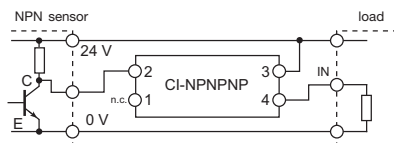

# Single relay modules quick selection table

These tables allow you to quickly select only the items, then check if all product's technical data meet your application requirements.

Number of relays	Input rated voltage	Output		Notes	Type	Cat. No.	Page
		type / no. of contacts	rated current				
1	12 Vdc	SPDT	16A	(2)	RF1012D	XRF1012D	102
1	12 Vdc	SPDT	10A	(1)	CM1C012	XCM1C012	103
1	12 Vdc	DPDT	5A	(1)	CM2C012	XCM2C012	104
1	12 Vdc	4PDT	3A	(1)	CM4C012	XCM4C012	105
1	12 Vac	SPDT	10A	(1)	CM1A012	XCM1A012	106
1	12 Vac	DPDT	5A	(1)	CM2A012	XCM2A012	107
1	12 Vac/dc	SPDT	6A	(1)	CWRE7-0848	X766848	110
1	24 Vdc	SPST(NO)	5A	(2)	RFA024D	XRFA024D	101
1	24 Vdc	SPDT	16A	(1)	RE1024D	XRE1024D	101
1	24 Vdc	SPDT	16A	(2)	RF1024D	XRF1024D	101
1	24 Vdc	SPDT	12A	(1)	CM1C024	XCM1C024	103
1	24 Vdc	SPDT	12A	(1)	RE1824D	XRE1824D	101
1	24 Vdc	SPDT	12A	(2)	RF1824D	XRF1824D	101
1	24 Vdc	DPDT	8A	(1)	CM2C024	XCM2C024	104
1	24 Vdc	4PDT	3A	(1)	CM4C024	XCM4C024	105
1	24 Vac/dc	SPDT	6A	(1)	CWRE7-0842	X766842	110
1	24 Vac/dc	SPDT	6A	(2) (3)	CKR16	XCKR16	109
1	24 Vac/dc	DPDT	8A	(1)	RE2024D	XRE2024D	102
2	24 Vac/dc	DPST(NO)	5A	(2)	CKR25	XCKR25	109
1	24 Vac	SPDT	12A	(1)	CM1A024	XCM1A024	106
1	24 Vac	DPDT	8A	(1)	CM2A024	XCM2A024	107
1	48 Vdc	SPDT	10A	(1)	CM1C048	XCM1C048	103
1	48 Vdc	DPDT	5A	(1)	CM2C048	XCM2C048	104
1	48 Vac/dc	SPDT	6A	(1)	CWRE7-0845	X766845	110
1	110 Vdc	SPDT	10A	(1)	CM1C110	XCM1C110	103
1	110 Vdc	DPDT	5A	(1)	CM2C110	XCM2C110	104
1	110...120 Vac/dc	SPDT	6A	(1)	CWRE7-0846	X766846	110
1	120 Vac	SPDT	10A	(1)	CM1A120	XCM1A120	106
1	120 Vac	DPDT	5A	(1)	CM2A120	XCM2A120	107
1	230 Vac	SPDT	6A	(1)	CWRE7-0847	X766847	110
1	230 Vac	SPDT	10A	(1)	CM1A230	XCM1A230	106
1	230 Vac	DPDT	5A	(1)	CM2A230	XCM2A230	107

## Notes

- (1) version with pluggable relay
- (2) version with fixed relay
- (3) protection fuse on the contact
- (4) without LED and protection diode

# 24 Vdc SPDT single relay R series

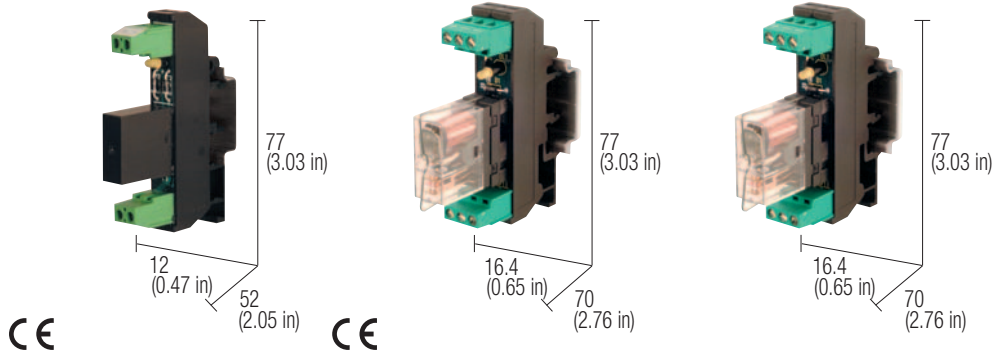

## NOTES

- (1) Relay model is not binding, they may be modified without prior warning. The technical data shown here is to be considered typical
- (2) Version available upon request; for information call our sales department, local agent or representative

## BLOCK DIAGRAM

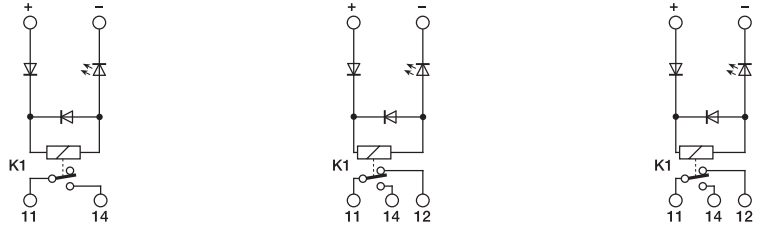

## VERSIONS

Pluggable relay  
Fixed relay

Cat. No. XRFA024D

Cat. No. XR\_1824D

Cat. No. XR\_1024D

-  
RFA024D (2)

RE1824D  
RF1824D

RE1024D  
RF1024D (2)

## INPUT TECHNICAL DATA

Rated voltage  
Rated current (1 channel)  
Turn ON time  
Turn OFF time  
Protection circuit

**24 Vdc ± 10%**

**24 Vdc ± 10%**

**24 Vdc ± 10%**

15 mA ± 10%

22 mA ± 10%

27 mA ± 10%

15 ms

15 ms

15 ms

5 ms

5 ms

5 ms

damping & polarity protection diode

damping & polarity protection diode

damping & polarity protection diode

## OUTPUT TECHNICAL DATA

Type and number of contacts  
Nominal current (resistive load)  
Current breaking power  
Current of the fuse max.

SPST(NO) AgSnO<sub>2</sub>  
5 A / 250 Vac

SPDT AgSnO<sub>2</sub>  
12 A / 250 Vac

SPDT AgSnO<sub>2</sub>  
16 A / 250 Vac

**5 A**

**12 A**

**16 A**

## GENERAL TECHNICAL DATA

Operating temperature  
Coil/contact isolation  
Isolation between output terminals  
Protection degree  
Overvoltage category / pollution degree  
Reference Standard  
Status display  
Connection terminals  
Housing material  
Approx. weight  
Mounting information

-10...+50°C

-10...+50°C

-10...+50°C

2.5 kVac / 60 s

2.5 kVac / 60 s

2.5 kVac / 60 s

0,5 kVac / 60 s (between open contact)

0,5 kVac / 60 s (between open contact)

0,5 kVac / 60 s (between open contact)

IP 00 IEC529, EN60529

IP 00 IEC529, EN60529

IP 00 IEC529, EN60529

III / 2

III / 2

III / 2

IEC 664-1, DIN VDE 0110.1

IEC 664-1, DIN VDE 0110.1

IEC 664-1, DIN VDE 0110.1

green LED

green LED

green LED

2.5 mm<sup>2</sup> fixed screw type AWG26-14

2.5 mm<sup>2</sup> fixed screw type AWG26-14

2.5 mm<sup>2</sup> fixed screw type AWG26-14

UL94V-0 plastic material

UL94V-0 plastic material

UL94V-0 plastic material

30 g (1.07 oz)

44 g (1.55 oz)

44 g (1.55 oz)

vertical on rail adjacent without gap

vertical on rail adjacent without gap

vertical on rail adjacent without gap

## MOUNTING ACCESSORIES

Mounting rail type according to IEC60715/TH35  
Mounting rail type according to IEC60715/G32

PR/3/AC, PR/3/AC/ZB, PR/3/AS, PR/3/AS/ZB  
PR/DIN/AC - PR/DIN/AS - PR/DIN/AL

Replacement relay (1)

Cat. No. 8904000

Cat. No. 8904001

Cat. No. 8904058

Screw type jumper black

# 24 Vdc SPDT single relay R series

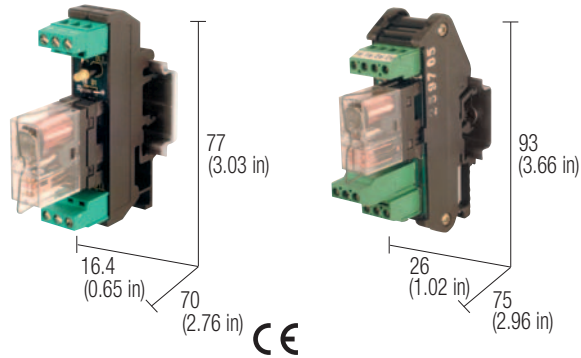

## NOTES

- (1) Relay model is not binding, they may be modified without prior warning. The technical data shown here is to be considered typical
- (2) Version available upon request

## BLOCK DIAGRAM

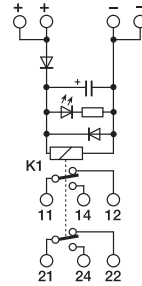
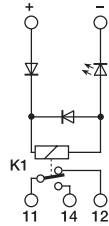

VERSIONS	Cat. No. XRF1012D	Cat. No. XRE2024D
Pluggable relay	-	RE2024D
Fixed relay	RF1012D	-
<b>INPUT TECHNICAL DATA</b>		
Rated voltage	<b>12 Vdc ± 10%</b>	<b>24 Vac / dc ± 10%</b>
Rated current (1 channel)	44 mA ± 10%	22 mA ± 10%
Turn ON time	15 ms	15 ms
Turn OFF time	5 ms	5 ms
Protection circuit	damping & polarity protection diode	damping & polarity protection diode
<b>OUTPUT TECHNICAL DATA</b>		
Type and number of contacts	SPDT AgSnO <sub>2</sub>	DPDT AgSnO <sub>2</sub>
Nominal current (resistive load)	16 A / 250 Vac	8 A / 250 Vac
Current breaking power	<b>16 A</b>	<b>8 A</b>
Current of the fuse max.	-	-
<b>GENERAL TECHNICAL DATA</b>		
Operating temperature	-10...+50°C	-10...+50°C
Coil/contact isolation	2.5 kVac / 60 s	2.5 kVac / 60 s
Isolation between output terminals	0,5 kVac / 60 s (between open contact)	0,5 kVac / 60 s (between open contact)
Protection degree	IP 20 IEC529, EN60529	IP 00 IEC529, EN60529
Overtoltage category / pollution degree	III / 2	III / 2
Reference Standard	IEC 664-1, DIN VDE 0110.1	IEC 664-1, DIN VDE 0110.1
Status display	green LED	green LED
Connection terminals	2.5 mm <sup>2</sup> fixed screw type AWG26-14	2.5 mm <sup>2</sup> fixed screw type AWG26-14
Housing material	UL94V-0 plastic material	UL94V-0 plastic material
Approx. weight	44 g (1.55 oz)	76 g (2.68 oz)
Mounting information	vertical on rail adjacent without gap	vertical on rail adjacent without gap
<b>MOUNTING ACCESSORIES</b>		
Mounting rail type according to IEC60715/TH35	<b>PR/3/AC, PR/3/AC/ZB, PR/3/AS, PR/3/AS/ZB</b>	
Mounting rail type according to IEC60715/G32	<b>PR/DIN/AC - PR/DIN/AS - PR/DIN/AL</b>	
Replacement relay (1)	Cat. No. 8904032	Cat. No. 8904002
Screw type jumper	black	black



# Single relay DC input series CM

- Pluggable relay
- Mounting on DIN rail or panel through central screw
- Compact dimensions
- Cross and slotted screws
- Screw type jumper available

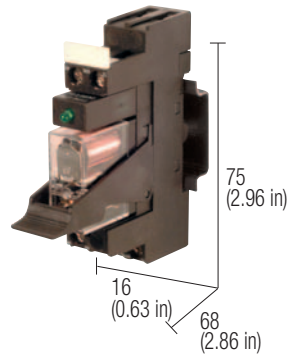

Screw type jumper available

## NOTES

The height dimension includes 35 mm DIN rail.

- (1) Relay model is not binding, they may be modified without prior warning. The technical data shown here is to be considered typical.
- (2) On request, there are available versions without signalling and protection circuit; for the order, please add the suffix "Z" to the item code (for example: XCM1C024Z).
- (3) On request, there are available versions with gold-plated contact; for the order, please add the suffix "U" to the item code (for example: XCM1C024U).

## BLOCK DIAGRAM

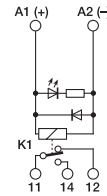

## VERSIONS

- 12 Vdc
- 24 Vdc
- 48 Vdc
- 110 Vdc

Cat. No. XCM1C012	Cat. No. XCM1C024	Cat. No. XCM1C048	Cat. No. XCM1C110
CM1C012	CM1C024	CM1C048	CM1C0110

## INPUT TECHNICAL DATA

Rated voltage	12 Vdc ±10%	24 Vdc ±10%	48 Vdc ±10%	110 Vdc ±10%
Rated current (1 channel)	44 mA ±10%	22 mA ±10%	12 mA ±10%	11 mA ±10%
Turn ON time	15 ms	15 ms	15 ms	15 ms
Turn OFF time	5 ms	5 ms	5 ms	20 ms

damping diode (2)

## OUTPUT TECHNICAL DATA

Type and number of contacts	SPDT AgSnO <sub>2</sub> (3)
Nominal current (resistive load)	12 A / 250 Vac
Current breaking power	12 A
Current of the fuse max.	—

## GENERAL TECHNICAL DATA

Operating temperature range	-10...+50°C
Coil/contact isolation	4 kVac / 60 s
Isolation between output terminals	1 kVac / 60 s (between open contact)
Protection degree	IP 20 IEC 529, EN60529
Overtoltage category/Pollution degree	III / 2
Reference Standard	IEC 664-1, DIN VDE 0110.1
Status display	green LED (2)
Connection terminal	2.5 mm <sup>2</sup> fixed screw type AWG26-14
Housing material	UL94V-0 plastic material
Approx. weight	54 g (1.90 oz)
Mounting information	vertical on rail adjacent without gap or panel with screw

## MOUNTING ACCESSORIES

Mounting rail type according to IEC60715/TH35-7.5	PR/3/AC, PR/3/AC/ZB, PR/3/AS, PR/3/AS/ZB			
Mounting rail type according to IEC60715/G32	—			
Replacement relay (1)	Cat. No. 8904039	Cat. No. 8904001	Cat. No. 8904008	Cat. No. 8904047
Screw type jumper	black	Cat. No. XCMB16B	—	—
	white	—	—	—
	blue	—	—	—

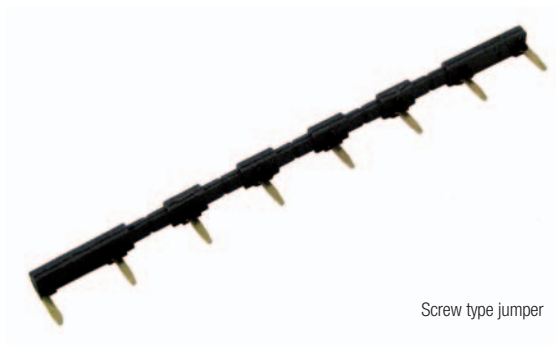

Screw type jumper

# DPDT single relay DC input series CM

- Pluggable relay
- Mounting on DIN rail or panel through central screw
- Compact dimensions
- Cross and slotted screws
- Screw type jumper available

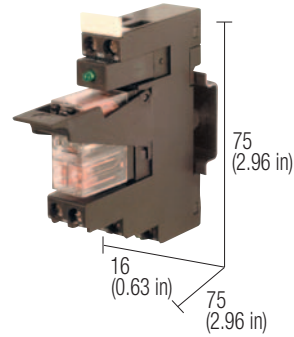

Screw type jumper available

## NOTES

The height dimension includes 35 mm DIN rail.

(1) Relay model is not binding, they may be modified without prior warning. The technical data shown here is to be considered typical.

## BLOCK DIAGRAM

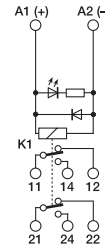

## VERSIONS

- 12 Vdc
- 24 Vdc
- 48 Vdc
- 110 Vdc

Cat. No. XCM2C012	Cat. No. XCM2C024	Cat. No. XCM2C048	Cat. No. XCM2C110
CM2C012	CM2C024	CM2C048	CM2C0110

## INPUT TECHNICAL DATA

Rated voltage	12 Vdc $\pm 10\%$	24 Vdc $\pm 10\%$	48 Vdc $\pm 10\%$	110 Vdc $\pm 10\%$
Rated current (1 channel)	44 mA $\pm 10\%$	22 mA $\pm 10\%$	24 mA $\pm 10\%$	11 mA $\pm 10\%$
Turn ON time	15 ms	15 ms	15 ms	15 ms
Turn OFF time	5 ms	5 ms	5 ms	20 ms

damping diode

## OUTPUT TECHNICAL DATA

Type and number of contacts	DPDT AgSnO <sub>2</sub>
Nominal current (resistive load)	8 A / 250 Vac
Current breaking power	8 A
Current of the fuse max.	—

## GENERAL TECHNICAL DATA

Operating temperature range	-10...+50°C
Coil/contact isolation	4 kVac / 60 s
Isolation between output terminals	1 kVac / 60 s (between open contact)
Protection degree	IP 20 IEC 529, EN60529
Overvoltage category/Pollution degree	III / 2
Reference Standard	IEC 664-1, DIN VDE 0110.1
Status display	green LED
Connection terminal	2.5 mm <sup>2</sup> fixed screw type AWG26-14
Housing material	UL94V-0 plastic material
Approx. weight	67 g (2.37 oz)
Mounting information	vertical on rail adjacent without gap or panel with screw

## MOUNTING ACCESSORIES

Mounting rail type according to IEC60715/TH35-7.5	
Mounting rail type according to IEC60715/G32	
Replacement relay	(1)
Screw type jumper	black white blue

## PR/3/AC, PR/3/AC/ZB, PR/3/AS, PR/3/AS/ZB

Cat. No. 8904040	Cat. No. 8904002	Cat. No. 8904009	Cat. No. 8904054
	Cat. No. XCMB16B		



Screw type jumper

# 4PDT single relay DC input series CM

- Pluggable relay
- Mounting on DIN rail or panel through central screw
- Compact dimensions
- Cross and slotted screws
- Screw type jumper available

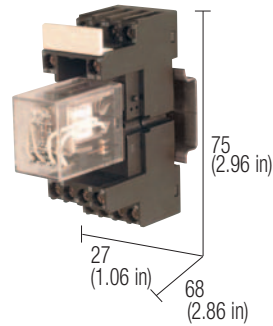

## NOTES

The height dimension includes 35 mm DIN rail.

(1) Relay model is not binding, they may be modified without prior warning. The technical data shown here is to be considered typical

(2) Version available upon request; for information call our sales department, local agent or representative

## BLOCK DIAGRAM

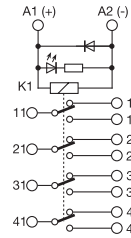

## VERSIONS

- 12 Vdc
- 24 Vdc
- 48 Vdc
- 110 Vdc

Cat. No. XCM4C012	Cat. No. XCM4C024	Cat. No. XCM1C048	Cat. No. XCM1C110
CM4C012 (2)	CM4C024 (2)	—	—

## INPUT TECHNICAL DATA

Rated voltage	12 Vdc $\pm 10\%$	24 Vdc $\pm 10\%$	
Rated current (1 channel)	75 mA $\pm 10\%$	38 mA $\pm 10\%$	
Turn ON time	20 ms	20 ms	
Turn OFF time	20 ms	20 ms	
Protection circuit			damping diode

## OUTPUT TECHNICAL DATA

Type and number of contacts	4PDT AgSnO <sub>2</sub>
Nominal current (resistive load)	3 A / 250 Vac
Current breaking power	3 A
Current of the fuse max.	—

## GENERAL TECHNICAL DATA

Operating temperature range	-10...+50°C
Coil/contact isolation	4 kVac / 60 s
Isolation between output terminals	1 kVac / 60 s (between open contact)
Protection degree	IP 20 IEC 529, EN60529
Overvoltage category/Pollution degree	III / 2
Reference Standard	IEC 664-1, DIN VDE 0110.1
Status display	green LED
Connection terminal	2.5 mm <sup>2</sup> fixed screw type AWG26-14
Housing material	UL94V-0 plastic material
Approx. weight	
Mounting information	vertical on rail adjacent without gap or panel with screw

## MOUNTING ACCESSORIES

Mounting rail type according to IEC60715/TH35-7.5	
Mounting rail type according to IEC60715/G32	
Replacement relay	(1)
Screw type jumper	black white blue

## PR/3/AC, PR/3/AC/ZB, PR/3/AS, PR/3/AS/ZB

Cat. No. 8904018	Cat. No. 8904030		
	Cat. No. XCMB27B		



Screw type jumper

# Single relay AC input series CM

- Pluggable relay
- Mounting on DIN rail or panel through central screw
- Compact dimensions
- Cross and slotted screws
- Screw type jumper available

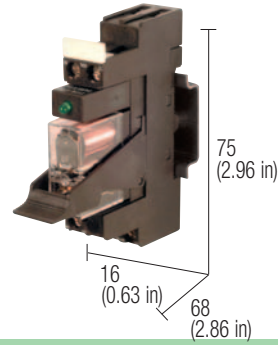

Screw type jumper available



## NOTES

The height dimension includes 35 mm DIN rail.

(1) Relay model is not binding, they may be modified without prior warning. The technical data shown here is to be considered typical

(2) Version available upon request; for information call our sales department, local agent or representative

## BLOCK DIAGRAM

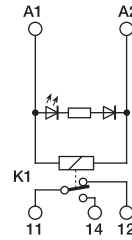

## VERSIONS

- 12 Vdc
- 24 Vdc
- 120 Vdc
- 230 Vdc

Cat. No. XCM1A012	Cat. No. XCM1A024	Cat. No. XCM1A120	Cat. No. XCM1A230
CM1A012 (2)	CM1A024	CM1A120 (2)	CM1A230

## INPUT TECHNICAL DATA

	12 Vac ±10%	24 Vac ±10%	120 Vac ±10%	230 Vac ±10%
Rated voltage	12 Vac ±10%	24 Vac ±10%	120 Vac ±10%	230 Vac ±10%
Rated current (1 channel)	95 mA ±10%	48 mA ±10%	10.5 mA ±10%	6 mA ±10%
Turn ON time	15 ms	15 ms	15 ms	15 ms
Turn OFF time	10 ms	10 ms	10 ms	10 ms
Protection circuit	—			

## OUTPUT TECHNICAL DATA

Type and number of contacts	SPDT AgSnO <sub>2</sub>
Nominal current (resistive load)	12 A / 250 Vac
Current breaking power	12 A
Current of the fuse max.	—

## GENERAL TECHNICAL DATA

Operating temperature range	-10...+50°C
Coil/contact isolation	4 kVac / 60 s
Isolation between output terminals	1 kVac / 60 s (between open contact)
Protection degree	IP 20 IEC 529, EN60529
Overvoltage category/Pollution degree	III / 2
Reference Standard	IEC 664-1, DIN VDE 0110.1
Status display	green LED
Connection terminal	2.5 mm <sup>2</sup> fixed screw type AWG26-14
Housing material	UL94V-0 plastic material
Approx. weight	54 g (1.91 oz)
Mounting information	vertical on rail adjacent without gap or panel with screw

## MOUNTING ACCESSORIES

Mounting rail type according to IEC60715/TH35-7.5	
Mounting rail type according to IEC60715/G32	
Replacement relay	(1)
Screw type jumper	black white blue

## PR/3/AC, PR/3/AC/ZB, PR/3/AS, PR/3/AS/ZB

Cat. No. 8904016	Cat. No. 8904048	Cat. No. 8904049	Cat. No. 8904050
	XCMB16B		



Screw type jumper

# DPDT single relay AC input series CM

- Pluggable relay
- Mounting on DIN rail or panel through central screw
- Compact dimensions
- Cross and slotted screws
- Screw type jumper available

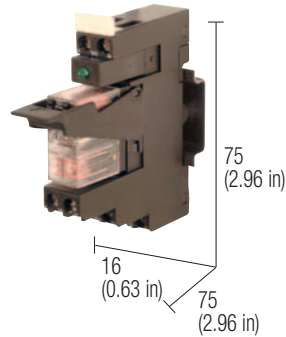

Screw type jumper available

## NOTES

The height dimension includes 35 mm DIN rail.

(1) Relay model is not binding, they may be modified without prior warning. The technical data shown here is to be considered typical

(2) Version available upon request; for information call our sales department, local agent or representative

## BLOCK DIAGRAM

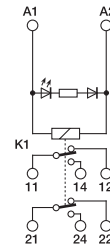

## VERSIONS

- 12 Vac
- 24 Vac
- 120 Vac
- 230 Vac

Cat. No. XCM2A012	Cat. No. XCM2A024	Cat. No. XCM2A120	Cat. No. XCM2A230
CM2A012 (2)	CM2A024	CM2A120 (2)	CM2A230

## INPUT TECHNICAL DATA

Rated voltage	12 Vac $\pm 10\%$	24 Vac $\pm 10\%$	120 Vac $\pm 10\%$	230 Vac $\pm 10\%$
Rated current (1 channel)	95 mA $\pm 10\%$	48 mA $\pm 10\%$	10.5 mA $\pm 10\%$	6 mA $\pm 10\%$
Turn ON time	15 ms	15 ms	15 ms	15 ms
Turn OFF time	10 ms	10 ms	10 ms	10 ms
Protection circuit	—			

## OUTPUT TECHNICAL DATA

Type and number of contacts	DPDT AgSnO <sub>2</sub>
Nominal current (resistive load)	8 A / 250 Vac
Current breaking power	8 A
Current of the fuse max.	—

## GENERAL TECHNICAL DATA

Operating temperature range	-10...+50°C
Coil/contact isolation	4 kVac / 60 s
Isolation between output terminals	1 kVac / 60 s (between open contact)
Protection degree	IP 20 IEC 529, EN60529
Overvoltage category/Pollution degree	III / 2
Reference Standard	IEC 664-1, DIN VDE 0110.1
Status display	green LED
Connection terminal	2.5 mm <sup>2</sup> fixed screw type AWG26-14
Housing material	UL94V-0 plastic material
Approx. weight	67 g (2.37 oz)
Mounting information	vertical on rail adjacent without gap or panel with screw

## MOUNTING ACCESSORIES

- Mounting rail type according to IEC60715/TH35-7.5
- Mounting rail type according to IEC60715/G32

	PR/3/AC, PR/3/AC/ZB, PR/3/AS, PR/3/AS/ZB
Replacement relay (1)	Cat. No. 8904017   Cat. No. 8904055   Cat. No. 8904056   Cat. No. 8904057
Screw type jumper	black white blue Cat. No. XCMB16B



Screw type jumper



## CK system interface

The series is a collection of interfaces for sensors and actuators, is composed by a wide range of electromechanical relay and solid state relay modules and passive interfaces in modular housings, which are only 6 mm wide thus saving valuable space. All products are mounted inside the CK housing, which is also available for use as a housing for custom. The CK housing can be equipped with six 2.5 mm spring-clamp terminals and four contacts for the insertion of a PTC parallel connection bridge, which provides for quick and easy circuit bridging and saves space and harness time.

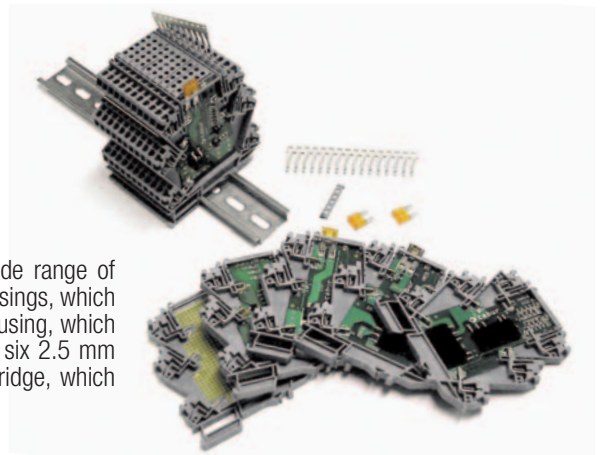

### The product range is currently composed by:

- Single electromechanical relay with 6 A/250 Vac SPDT protected with replaceable fuse, status Led display on front panel, AC/DC input and positive or negative common on relay coil.
- Double electromechanical relay with 5 A/250 Vac SPST (NO), two status LED displays on front panel, AC/DC input and positive or negative common on relay coil.
- Single solid state relay for common negative load, 5 A /48 Vdc output current, protected with replaceable fuse, status LED display on front panel and positive or negative common on input.
- Double solid state relay suitable for 12-24 Vdc 2.5 A loads, status LED display on front panel and positive or negative common of the input and output as well.
- Diode-holder modules with common anode (CK...AC) or common cathode (CK...CC).
- Lamp and LED test modules.
- Supply connection and distribution modules with LED display.

### Composition of an interface with the CK System:

- The required modules must be selected and mounted on the DIN rail.
- The common poles of inputs and outputs can be connected in parallel using the fast connection bridges **PTC/CK/42**.
- For the connection of inputs and outputs of the relay module interface, we recommend to use the **CKF** supply distribution module: it allows to connect and distribute the feeding potential to inputs and outputs on all adjacent modules; the CKF module can be mounted as first module, or even better, in the middle position of the interfaces assembly, to divide 50+50% the current on the bridge and to reduce voltage drop and heating; the CKF- is available with LED for ON display, and is equipped with four 2.5 mm / AWG 26 ÷ 14 / 24 A rated spring-clamp terminals - input and output.
- In order to assure the IP XXB protection degree, the last module must be protected and insulated using the **CK/PT** end section.
- Main technical data and BLOCK DIAGRAM are printed on one side of each module; for individual terminal block marking, CNU/8 marking tags are available; CNU/8 marking tags are available in blank format for pen or plotter marking, or with the Cabur Jet marking printer.
- If the input and output power supply cables of the interface assembly are directly connected to eg. the first module, two cables must be connected on a single terminal block (feeding wire and load wire) forcing to reduce the cross-section of each conductor to less than 2,5 mm<sup>2</sup>; consequently, this means a current and a reduction of the total number of relay modules that can be fed; the problem can be solved by using the CKF feeder distribution module as described in the third point.

### Easy Bridge system

The fast connection bridge **PTC/CK/42** has 42 poles, and a rated current of 32 A; WARNING: the total current is limited by the rated current of the spring-clamp terminal block (24 A): if a PTC/CK serves 10 relays, a rated current of 2,4 A can be distributed on to each relay.

The use of PTC/CK bridges is simple and cost effective; the following instructions must be followed:

- after having cut the PTC/CK/42-pole bar according to required number of poles, in order to maintain the IPXXB protection degree the bar must be sheared in proximity of the end poles (see pictures 1 and 2);
- insert the jumper in the slot of the CK terminals (see picture 3);
- by using the blade of a screwdriver, the PTC bridge must be pushed down until it snaps into the female contacts; in case of long jumpers, the operation shall be started by pushing the bridge in the middle, then gradually on left / right sides; the jumper will then result completely IPXXB insulated (see picture 4);
- to remove the jumper, the blade of a screwdriver shall be inserted into the slot provided in the upper side of the PTC bridge, then lifted up and finally extracted; in case of long jumpers, the bridge shall be lifted in the middle, then gradually on left / right sides (pictures 5 and 6).

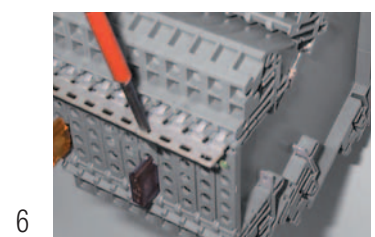
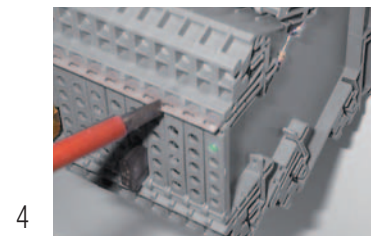
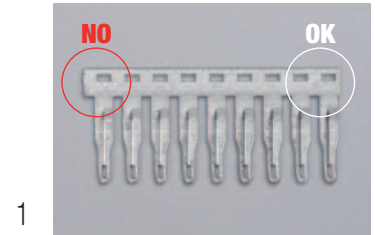

## 24 Vdc relay modules CKR series

- Built-in replaceable contact protection fuse
- AC/DC common negative or positive input
- Status LED display, reverse polarity protection, crow-bar diode
- 6 mm wide
- Plug-in jumper available

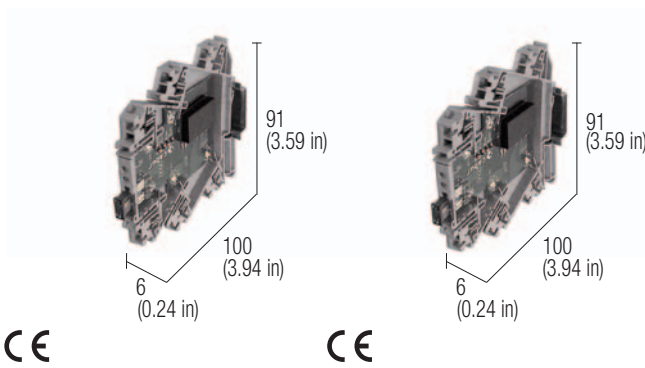

### NOTES

- (1) The contact rated voltage is 250 Vac; max operating voltage of the contact of the module is 50 Vac-Vdc, limited by the voltage ratings of the adopted type of fuse, which is rated for  $\leq 50$  Vac-75 Vdc SELV voltages; WARNING: if used with higher voltage, it does not guarantee breaking power and thus safety, and IP protection degree is lowered to IP 00; fuses with higher current ratings are not allowed and do not protect the contact against short circuit and overcurrents
- (2) Version available upon request.
- (3) In order to assure the IP20 protection degree, the last module must be protected and insulated using the CK/PT end section.

### BLOCK DIAGRAM

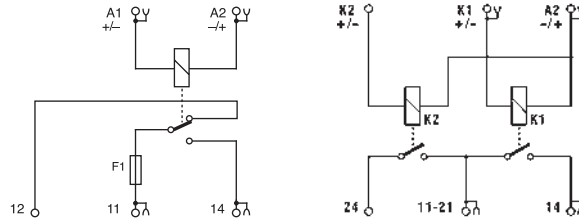

### VERSIONS

- 1 channel
- 2 channels

### Cat. No. XCKR16

CKR16

### Cat. No. XCKR25

CKR25 (2)

### INPUT TECHNICAL DATA

- Rated voltage
- Rated current (1 channel)
- Turn ON time
- Turn OFF time
- Protection circuit

**24 Vac/dc  $\pm 10\%$**

$\leq 15$  mA  $\pm 10\%$  @ 24 Vdc

5 ms

10 ms

bridge rectifier

**24 Vac/dc  $\pm 10\%$**

$\leq 13$  mA  $\pm 10\%$  @ 24 Vdc

5 ms

10 ms

bridge rectifier

### OUTPUT TECHNICAL DATA

- Type and number of contacts
- Nominal current (resistive load)
- Current breaking power
- Current of the fuse max.

SPDT AgSnO<sub>2</sub>

**6 A / 250 Vac**

30 A

—

2PST (NO) AgSnO<sub>2</sub>

**5 A / 250 Vac**

30 A

—

### GENERAL TECHNICAL DATA

- Operating temperature
- Coil/contact isolation
- Isolation between output terminals
- Protection degree
- Overvoltage category / pollution degree
- Reference Standard
- Status display
- Connection terminals
- Housing material
- Approx. weight
- Mounting information
- Mounting information

-20...+60°C

3 kVac / 60 s

IP 20 IEC529, EN60529

II / 2

IEC 664-1, DIN VDE 0110.1

green LED

2.5 mm<sup>2</sup> AWG26-14 fixed spring type

polyamide UL94V-0

40 g (1.41 oz)

vertical on rail adjacent without gap

-20...+60°C

3 kVac / 60 s

IP 00 IEC529, EN60529

II / 2

IEC 664-1, DIN VDE 0110.1

green LED

2.5 mm<sup>2</sup> AWG26-14 fixed spring type

polyamide UL94V-0

43 g (1.52 oz)

vertical on rail adjacent without gap

### ACCESSOIRES DE MONTAGE

- Mounting rail type according to IEC60715/TH35
- Mounting rail type according to IEC60715/G32
- Replacement relay (1)
- Plug-in jumper —
- Marking tags blank
- End plate

### PR/3/AC, PR/3/AC/ZB, PR/3/AS, PR/3/AS/ZB

Cat. No. PTCK42 (42 poles)

Cat. No. NU0851

Cat. No. XCKPT

Cat. No. PTCK42 (42 poles)

Cat. No. NU0851

Cat. No. XCKPT

# Relay modules AC/DC input series CWRE

- Pluggable relay
- Status LED display
- 6.2 mm wide
- Plug-in jumper available

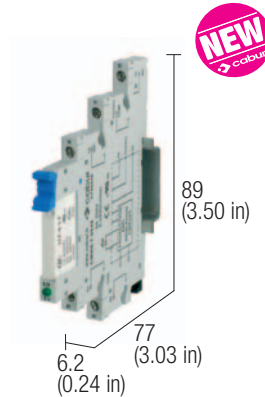

## NOTES

The height dimension includes 35 mm DIN rail.

- (1) Version available upon request; for information call our sales department, local agent or representative.
- (2) Relay model is not binding, they may be modified without prior warning. The technical data shown here is to be considered typical.

## APPLICAZIONI

The CWRE series is suitable for the commutation of signals and is equipped with a pull-out relay to make the maintenance operations easy. Furthermore this series offers the possibility to execute the parallel on both the input and output side by the means of a proper comb jumper.

## BLOCK DIAGRAM

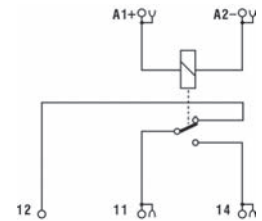

## VERSIONS

12 Vac/dc	(1)
24Vac/dc	
48 Vac/dc	(1)
115 Vac/dc	
230 Vac/dc	

Cat. No. X766848	Cat. No. X766842	Cat. No. X766845	Cat. No. X766846	Cat. No. X766847
CWRE7-0848 (1)	CWRE7-0842	CWRE7-0845 (1)	CWRE7-0846	CWRE7-0847

## INPUT TECHNICAL DATA

Rated voltage	
Rated current (1 channel)	
Turn ON time	
Turn OFF time	
Protection circuit	

12 Vac/dc ±10%	24 Vac/dc ±10%	48 Vac/dc ±10%	115 Vac/dc ±10%	230 Vac/dc ±10%
10 mA ±10%	7 mA ±10%	5 mA ±10%	4 mA ±10%	4 mA ±10%
8 ms	8 ms	7 ms	8 ms	8 ms
5 ms	5 ms	7 ms	13 ms	13 ms

damping diode and bridge rectifier

## OUTPUT TECHNICAL DATA

Type and number of contacts	
Nominal current (resistive load)	
Current breaking power	
Current of the fuse max.	

SPDT AgSnO <sub>2</sub> (3)
<b>6 A / 250 Vac ; 6 A / 30 Vdc</b>
DC 13: 24 V / 1A; 115V / 200 mA; 230 V / 100 mA
—

## GENERAL TECHNICAL DATA

Operating temperature	
Coil/contact isolation	
Isolation between output terminals	
Protection degree	
Overvoltage category / pollution degree	
Reference Standard	
Status display	
Connection terminals	
Housing material	
Approx. weight	
Mounting information	

−40...+70°C
4 kVac / 60 s
1 kVac / 60 s (between open contact)
IP 20 IEC 529, EN60529
III / 2
IEC 664.1, DIN VDE 0110.1
green LED
2.5 mm <sup>2</sup> fixed screw type AWG26-14
UL94V-0 plastic material
35 g (1.23 oz)
vertical on rail adjacent without gap

## MOUNTING ACCESSORIES

Mounting rail type according to IEC60715/TH35-7.5	
Mounting rail type according to IEC60715/G32	
Replacement relay	(2)
Plug-in jumper	black white blue

PR/3/AC, PR/3/AC/ZB, PR/3/AS, PR/3/AS/ZB	
—	
Cat. No. 8904027	
—	
—	
CWBK7-0813 (Cat. No. X766813) (20 poli)	

# Multiple relay modules quick selection table

These tables allow you to quickly select only the items, then check if all product's technical data meet your application requirements.

Number of relays	Input rated voltage	Output type / no. of contacts	Rated current	Notes	Type	Cat. No.	Page
4	24 Vdc	SPDT	12 A	(1) (4)	R41E24	XR041E24	113
8	24 Vdc	SPDT	12 A	(1) (4)	R81E24	XR081E24	113
16	24 Vdc	SPDT	12 A	(1) (4)	R161E24	XR161E24	113
4	24 Vac/dc	SPDT	12 A	(1) (6)	R41EAD	XR041EAD	114
8	24 Vac/dc	SPDT	12 A	(1) (6)	R81EAD	XR081EAD	114
16	24 Vac/dc	SPDT	12 A	(1) (6)	R161EAD	XR161EAD	114
4	24 Vac/dc	SPDT	12 A	(1) (6) (8)	R41U24F	XR041U24F	115
8	24 Vac/dc	SPDT	12 A	(1) (6) (8)	R81U24F	XR081U24F	115
16	24 Vac/dc	SPDT	12 A	(1) (6) (8)	R161U24F	XR161U24F	115
4	24 Vdc	DPDT	8 A	(1) (4)	R42E24	XR042E24	116
8	24 Vdc	DPDT	8 A	(1) (4)	R82E24	XR082E24	116
16	24 Vdc	DPDT	8 A	(1) (4)	R162E24	XR162E24	116
4	24 Vac/dc	DPDT	8 A	(1) (6)	R42EAD	XR042EAD	118
8	24 Vac/dc	DPDT	8 A	(1) (6)	R82EAD	XR082EAD	118
16	24 Vac/dc	DPDT	8 A	(1) (6)	R162EAD	XR162EAD	118
8	24 Vac/dc	SPDT	12 A	(1) (6) (9) (10)	RMP081CM	XRMP081CM	119
4	110 Vdc/120 Vac	SPDT	10 A	(1) (6)	R41E11A	XR041E1A	120
8	110 Vdc/120 Vac	SPDT	10 A	(1) (6)	R81E11A	XR081E1A	120
16	110 Vdc/120 Vac	SPDT	10 A	(1) (6)	R161E11A	XR161E1A	120
4	230 Vac	SPDT	10 A	(1) (6)	R41E22A	XR041E2A	121
8	230 Vac	SPDT	10 A	(1) (6)	R81E22A	XR081E2A	121
16	230 Vac	SPDT	10 A	(1) (6)	R161E22A	XR161E2A	121
4	24 Vac/dc	SPDT	8 A	(2) (6)	CR4-1	XCR41	122
4	24 Vac/dc	SPDT	8 A	(1) (6)	CRE4-1	XCRE41	122
8	24 Vac/dc	SPST(NO)	8 A	(1) (6)	CRE8-1	XCRE81	122
8	24 Vac/dc	SPST(NO)	8 A	(2) (6)	CR8-1	XCR81	122
4	24 Vac/dc	DPDT	8 A	(2) (6)	CR4-2SC	XCR42SC	123
4	24 Vac/dc	DPDT	8 A	(1) (6)	CRE4-2SC	XCRE42SC	123

## Note

- |                                       |   |
|---------------------------------------|---|
| (1) version with pluggable relay      | (6) universal control voltage, negative DC command, positive DC, AC |
| (2) version with fixed relay          | (7) with connector input command                                    |
| (3) with socket but without relay     | (8) with protection fuse on the relay contact                       |
| (4) negative common, positive command | (9) with test push button   |
| (5) positive common, negative command | (10) with test switch   |

# 24 Vdc SPDT relay modules negative common

- DC control voltage
- Negative control voltage
- Status LED display
- Pluggable relay

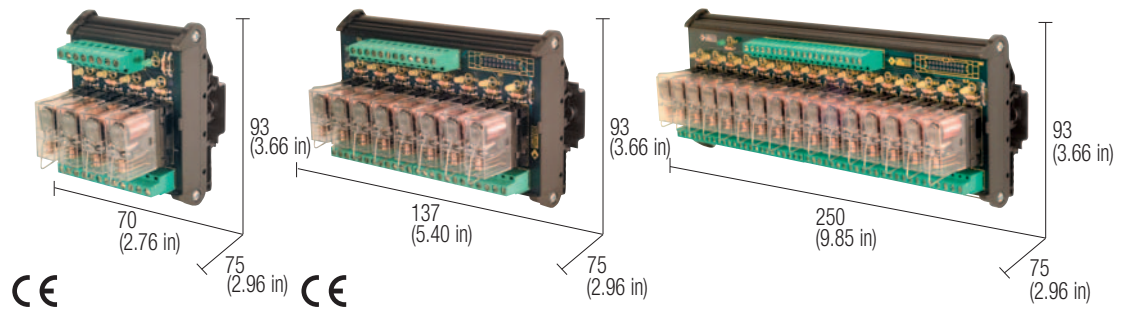

## NOTES

The height dimension includes 35 mm DIN rail.  
 (1) Relay model is not binding, they may be modified without prior warning. The technical data shown here is to be considered typical

## BLOCK DIAGRAM

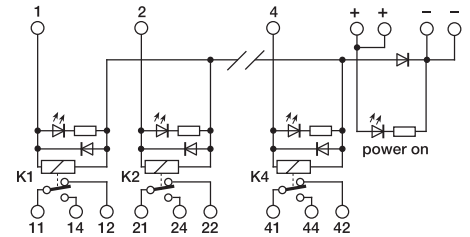

4 relay module

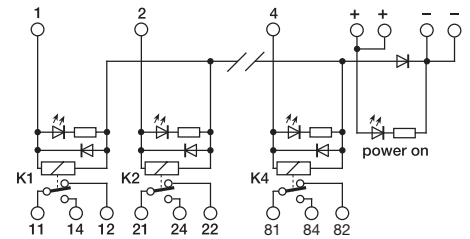

8 relay module

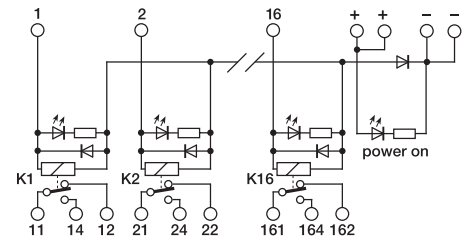

16 relay module

## VERSIONS

	Cat. No. XR041E24	Cat. No. XR081E24	Cat. No. XR161E24
4 relay module	R41E24		
8 relay module		R81E24	
16 relay module			R161E24

## INPUT TECHNICAL DATA

Rated voltage	24 Vdc $\pm$ 10%
Rated current (1 channel)	22 mA $\pm$ 10%
Turn ON time	15 ms
Turn OFF time	5 ms
Protection circuit	damping and polarity protection diode

## OUTPUT TECHNICAL DATA

Type and number of contacts	SPDT AgSnO <sub>2</sub>
Nominal load (resistive)	12 A / 250 Vac
Current breaking power	12 A
Current of the fuse max.	—

## GENERAL TECHNICAL DATA

Operating temperature range	-10...+50°C
Coil/contact isolation	2.5 kVac / 60 s
Isolation between output terminals	1 kVac / 60 s (between open contact)
Protection degree	IP 20 IEC 529, EN60529
Overvoltage category / Pollution degree	III / 2
Reference Standard	IEC 664-1, DIN VDE 0110.1
Status display	green LED / yellow LED
Connection terminal	2.5 mm <sup>2</sup> fixed screw type
Housing material	UL94V-0 plastic material
Approx. weight	188 g (6.63 oz)   342 g (12.06 oz)   657 g (23.17 oz)
Mounting information	vertical on rail adjacent without gap

## MOUNTING ACCESSORIES

Mounting rail type according to IEC60715/TH35	PR/3/AC, PR/3/AC/ZB, PR/3/AS, PR/3/AS/ZB
Mounting rail type according to IEC60715/G32	PR/DIN/AC - PR/DIN/AS - PR/DIN/AL
Replacement relay (1)	Cat. No. 8904001
Screw type jumper	red — white — blue —



# 24 Vdc SPDT relay modules positive common

- DC control voltage
- Positive control voltage
- Status LED display
- Pluggable relay

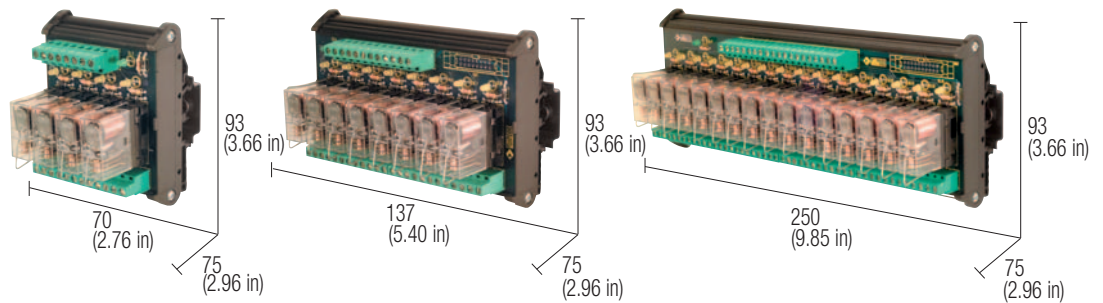

## NOTES

The height dimension includes 35 mm DIN rail.  
 (1) Relay model is not binding, they may be modified without prior warning. The technical data shown here is to be considered typical

Article available until sell-out  
 XR041E24P will be replaced by XR041EAD  
 XR081E24P will be replaced by XR081EAD  
 XR161E24P will be replaced by XR161EAD

## BLOCK DIAGRAM

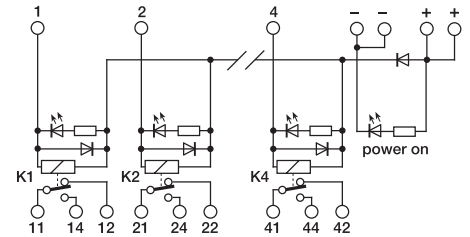

4 relay module

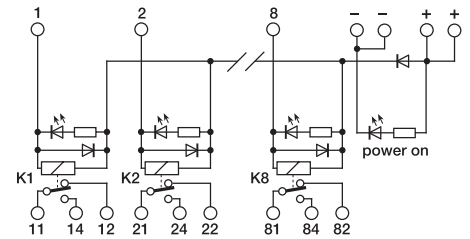

8 relay module

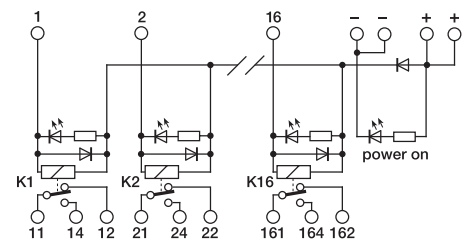

16 relay module

## VERSIONS

- 4 relay module
- 8 relay module
- 16 relay module

Cat. No. XR041E24P	Cat. No. XR081E24P	Cat. No. XR161E24P
R41E24P	R81E24P	R161E24P

## INPUT TECHNICAL DATA

Rated voltage	24 Vdc ± 10%
Rated current (1 channel)	22 mA ± 10%
Turn ON time	15 ms
Turn OFF time	5 ms
Protection circuit	damping and polarity protection diode

## OUTPUT TECHNICAL DATA

Type and number of contacts	SPDT AgSnO <sub>2</sub>
Nominal load (resistive)	12 A / 250 Vac
Current breaking power	12 A
Current of the fuse max.	—

## GENERAL TECHNICAL DATA

Operating temperature range	-10...+50°C
Coil/contact isolation	2.5 kVac / 60 s
Isolation between output terminals	1 kVac / 60 s (between open contact)
Protection degree	IP 00 IEC 529, EN60529
Overtoltage category / Pollution degree	III / 2
Reference Standard	IEC 664-1, DIN VDE 0110.1
Status display	green LED / yellow LED
Connection terminal	2.5 mm <sup>2</sup> fixed screw type
Housing material	UL94V-0 plastic material
Approx. weight	188 g (6.63 oz)   342 g (12.06 oz)   657 g (23.17 oz)
Mounting information	vertical on rail adjacent without gap

## MOUNTING ACCESSORIES

Mounting rail type according to IEC60715/TH35	PR/3/AC, PR/3/AC/ZB, PR/3/AS, PR/3/AS/ZB
Mounting rail type according to IEC60715/G32	PR/DIN/AC - PR/DIN/AS - PR/DIN/AL
Replacement relay (1)	Cat. No. 8904001
Screw type jumper	red white blue

# 24 Vac/dc SPDT relay modules universal control voltage

- DC and AC control voltage
- Positive or negative control voltage
- Status LED display
- Pluggable relay

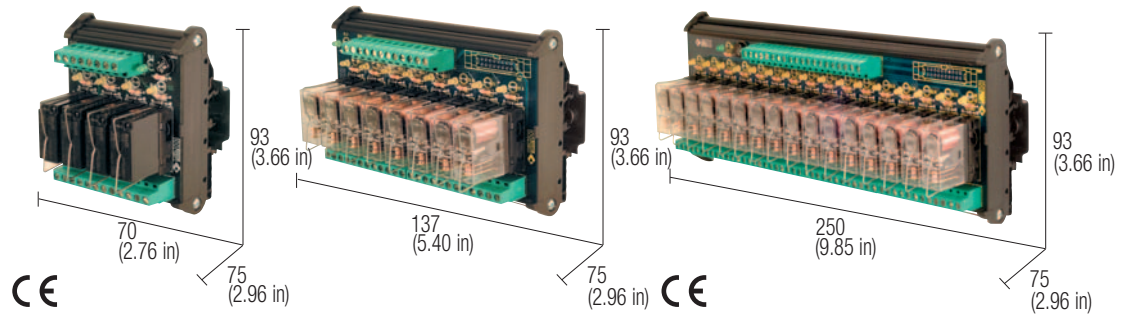

## NOTES

The height dimension includes 35 mm DIN rail.  
 (1) Relay model is not binding, they may be modified without prior warning. The technical data shown here is to be considered typical  
 (2) Version available upon request.

### POWER SUPPLY

A1 = +	A2 = -	negative common
A1 = -	A2 = +	positive common
A1 = ~	A2 = ~	AC power supply

## BLOCK DIAGRAM

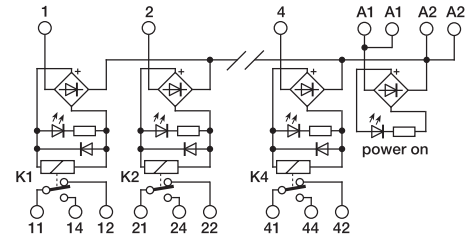

4 relay module

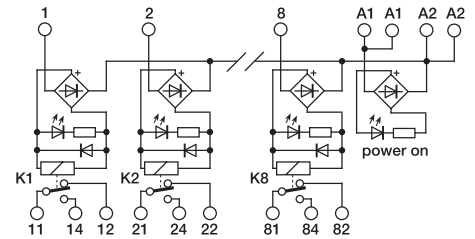

8 relay module

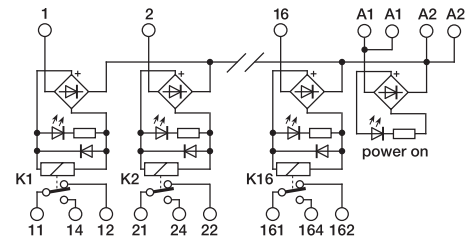

16 relay module

## VERSIONS

4 relay module

8 relay module

16 relay module

Cat. No. XR041EAD	Cat. No. XR081EAD	Cat. No. XR161EAD
R41EAD	R81EAD	R161EAD

## INPUT TECHNICAL DATA

Rated voltage	24 Vac/dc $\pm$ 10%
Rated current (1 channel)	22 mA $\pm$ 10%
Turn ON time	15 ms
Turn OFF time	5 ms
Protection circuit	damping diode and bridge rectifier

## OUTPUT TECHNICAL DATA

Type and number of contacts	SPDT AgSnO <sub>2</sub>
Nominal load (resistive)	12 A / 250 Vac
Current breaking power	12 A
Current of the fuse max.	—

## GENERAL TECHNICAL DATA

Operating temperature range	-10...+50°C
Coil/contact isolation	2.5 kVac / 60 s
Isolation between output terminals	1 kVac / 60 s (between open contact)
Protection degree	IP 00 IEC 529, EN60529
Overtoltage category / Pollution degree	III / 2
Reference Standard	IEC 664-1, DIN VDE 0110.1
Status display	green LED / yellow LED
Connection terminal	2.5 mm <sup>2</sup> fixed screw type
Housing material	UL94V-0 plastic material
Approx. weight	192 g (6.76 oz)   345 g (12.18 oz)   688 g (24.29 oz)
Mounting information	vertical on rail adjacent without gap

## MOUNTING ACCESSORIES

Mounting rail type according to IEC60715/TH35	PR/3/AC, PR/3/AC/ZB, PR/3/AS, PR/3/AS/ZB
Mounting rail type according to IEC60715/G32	PR/DIN/AC - PR/DIN/AS - PR/DIN/AL
Replacement relay (1)	Cat. No. 8904001
Screw type jumper	red white blue

# 24 Vac/dc SPDT relay modules universal control voltage with fuse

- DC and AC control voltage
- Positive or negative control voltage
- Status LED display
- Pluggable relay
- Output contact with protection fuse

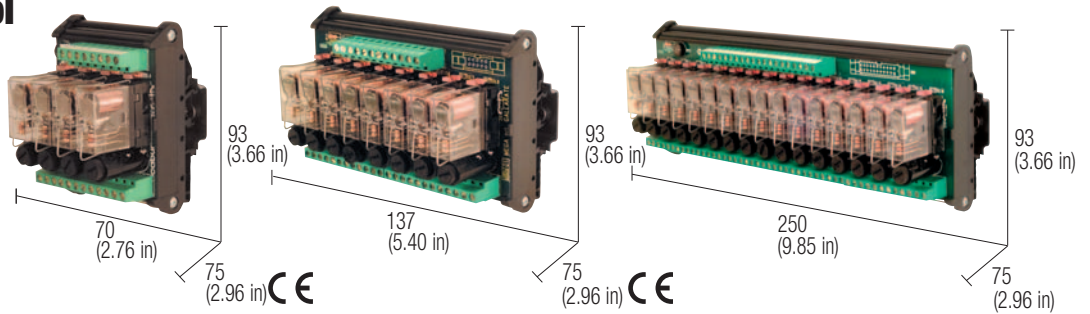

## NOTES

The height dimension includes 35 mm DIN rail. (1) Relay model is not binding, they may be modified without prior warning. The technical data shown here is to be considered typical. (2) The interface is supplied without a fuse and the screw plug of the fuse-holder is provided in a bag inside the packaging. The fuse must be dimensioned according to load. The max. value of 6.3 A is referred to EN60127-complying fuses and the homologation rated current of the fuseholder. Fuses of a higher value may damage the fuseholder and module.

## VERSIONS

4 relay module

8 relay module

16 relay module

## INPUT TECHNICAL DATA

Rated voltage	24 Vac/dc $\pm 10\%$
Rated current (1 channel)	22 mA $\pm 10\%$
Turn ON time	15 ms
Turn OFF time	10 ms
Protection circuit	damping diode and bridge rectifier

## OUTPUT TECHNICAL DATA

Type and number of contacts	SPDT AgSnO <sub>2</sub> per 4 relé
Nominal load (resistive)	12 A / 250 Vac
Current breaking power	12 A
Current of the fuse max.	6,3 A (2)

## GENERAL TECHNICAL DATA

Operating temperature range	-10...+50°C
Coil/contact isolation	2.5 kVac / 60 s
Isolation between output terminals	1 kVac / 60 s (between open contact)
Protection degree	IP 00 IEC 529, EN60529
Overvoltage category / Pollution degree	III / 2
Reference Standard	IEC 664-1, DIN VDE 0110.1
Status display	green LED / yellow LED
Connection terminal	2.5 mm <sup>2</sup> fixed screw type
Housing material	UL94V-0 plastic material
Approx. weight	210 g (7.41 oz)   326 g (11.51 oz)   770 g (27.18 oz)
Mounting information	vertical on rail adjacent without gap

## MOUNTING ACCESSORIES

Mounting rail type according to IEC60715/TH35	PR/3/AC, PR/3/AC/ZB, PR/3/AS, PR/3/AS/ZB
Mounting rail type according to IEC60715/G32	PR/DIN/AC - PR/DIN/AS - PR/DIN/AL
Replacement relay (1)	Cat. No. 8904001
Screw type jumper	red — white — blue —

## POWER SUPPLY

A1 = +	A2 = -	negative common
A1 = -	A2 = +	positive common
A1 = ~	A2 = ~	AC power supply

## BLOCK DIAGRAM

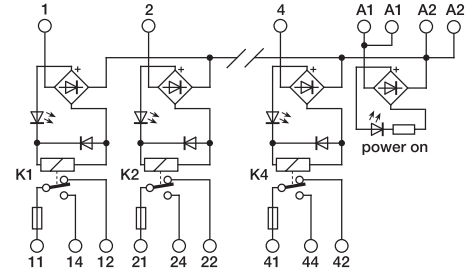

4 relay module

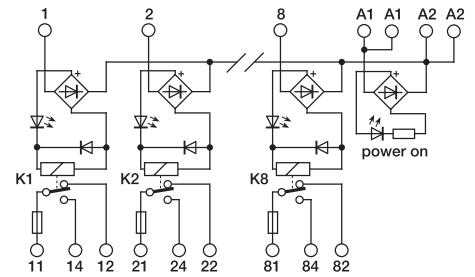

8 relay module

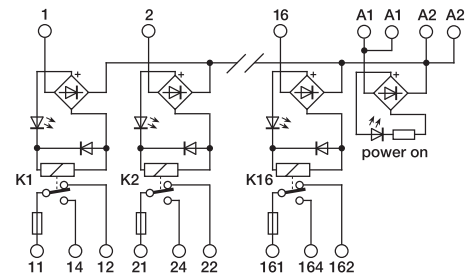

16 relay module

# 24 Vdc DPDT relay modules negative common

- DC control voltage
- Negative control voltage
- Status LED display
- Pluggable relay

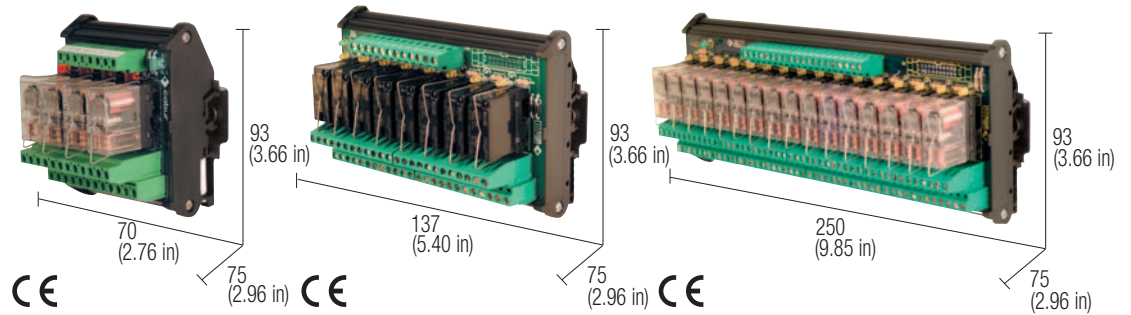

## NOTES

The height dimension includes 35 mm DIN rail.  
 (1) Relay model is not binding, they may be modified without prior warning. The technical data shown here is to be considered typical.

## BLOCK DIAGRAM

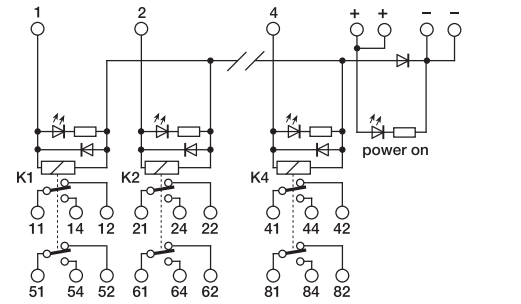

4 relay module

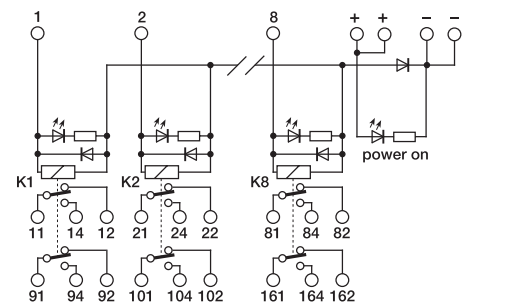

8 relay module

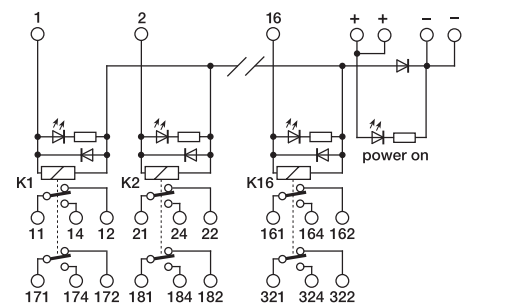

16 relay module

## VERSIONS

4 relay module

8 relay module

16 relay module

Cat. No. XR042E24	Cat. No. XR082E24	Cat. No. XR162E24
R42E24	R82E24	R162E24

## INPUT TECHNICAL DATA

Rated voltage	24 Vdc $\pm$ 10%
Rated current (1 channel)	22 mA $\pm$ 10%
Turn ON time	15 ms
Turn OFF time	10 ms
Protection circuit	damping and polarity protection diode

## OUTPUT TECHNICAL DATA

Type and number of contacts	DPDT AgNi
Nominal load (resistive)	8 A / 250 Vac
Current breaking power	8 A
Current of the fuse max.	—

## GENERAL TECHNICAL DATA

Operating temperature range	-10...+50°C
Coil/contact isolation	2.5 kVac / 60 s
Isolation between output terminals	1 kVac / 60 s (between open contact)
Protection degree	IP 00 IEC 529, EN60529
Overtoltage category / Pollution degree	III / 2
Reference Standard	IEC 664-1, DIN VDE 0110.1
Status display	green LED / yellow LED
Connection terminal	2.5 mm <sup>2</sup> fixed screw type
Housing material	UL94V-0 plastic material
Approx. weight	225 g (7.94 oz)   419 g (14.78 oz)   811 g (28.60 oz)
Mounting information	vertical on rail adjacent without gap

## MOUNTING ACCESSORIES

Mounting rail type according to IEC60715/TH35	PR/3/AC, PR/3/AC/ZB, PR/3/AS, PR/3/AS/ZB
Mounting rail type according to IEC60715/G32	PR/DIN/AC - PR/DIN/AS - PR/DIN/AL
Replacement relay (1)	Cat. No. 8904002
Screw type jumper	red white blue

# 24 Vdc DPDT relay modules positive common

- DC control voltage
- Positive control voltage
- Status LED display
- Pluggable relay

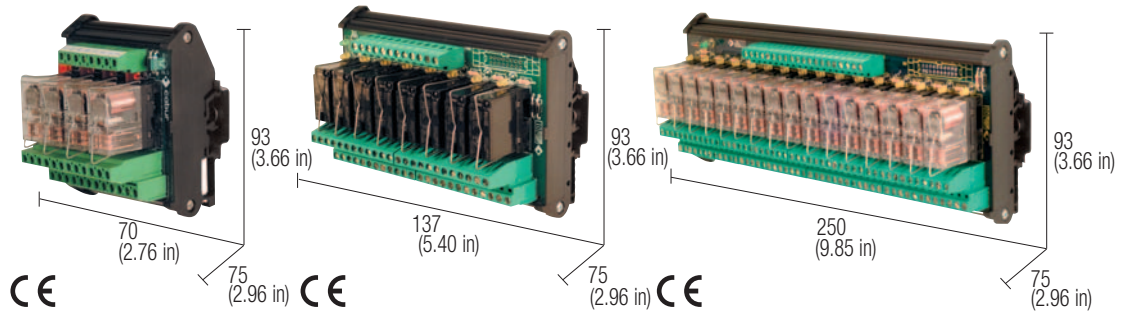

## NOTES

The height dimension includes 35 mm DIN rail.  
 (1) Relay model is not binding, they may be modified without prior warning. The technical data shown here is to be considered typical.

Article available until sell-out  
 XR042E24P will be replaced by XR042EAD  
 XR082E24P will be replaced by XR082EAD  
 XR162E24P will be replaced by XR162EAD

## BLOCK DIAGRAM

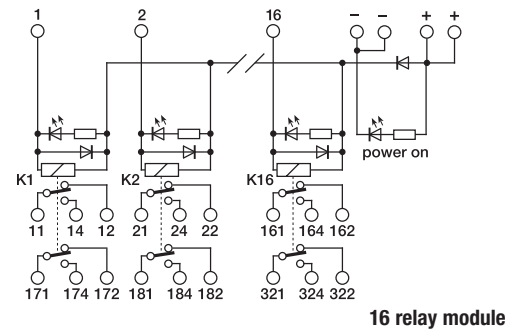
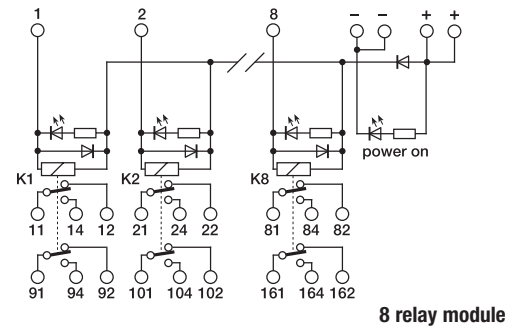
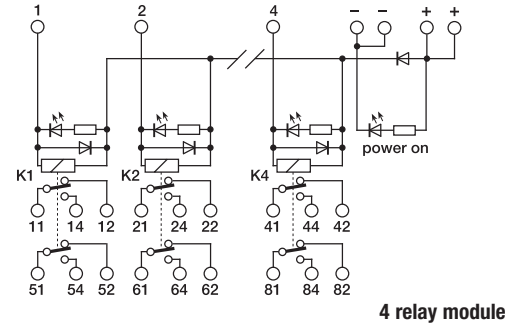

## VERSIONS

- 4 relay module
- 8 relay module
- 16 relay module

Cat. No. XR042E24P	Cat. No. XR082E24P	Cat. No. XR162E24P
R42E24P	R82E24P	R162E24P

## INPUT TECHNICAL DATA

Rated voltage	24 Vdc ± 10%
Rated current (1 channel)	22 mA ± 10%
Turn ON time	15 ms
Turn OFF time	5 ms
Protection circuit	damping and polarity protection diode

## OUTPUT TECHNICAL DATA

Type and number of contacts	DPDT AgNi
Nominal load (resistive)	8 A / 250 Vac
Current breaking power	8 A
Current of the fuse max.	—

## GENERAL TECHNICAL DATA

Operating temperature range	-10...+50°C
Coil/contact isolation	2.5 kVac / 60 s
Isolation between output terminals	1 kVac / 60 s (between open contact)
Protection degree	IP 00 IEC 529, EN60529
Overtoltage category / Pollution degree	III / 2
Reference Standard	IEC 664-1, DIN VDE 0110.1
Status display	green LED / yellow LED
Connection terminal	2.5 mm <sup>2</sup> fixed screw type
Housing material	UL94V-0 plastic material
Approx. weight	225 g (7.94 oz)   419 g (14.78 oz)   811 g (28.60 oz)
Mounting information	vertical on rail adjacent without gap

## MOUNTING ACCESSORIES

Mounting rail type according to IEC60715/TH35	PR/3/AC, PR/3/AC/ZB, PR/3/AS, PR/3/AS/ZB
Mounting rail type according to IEC60715/G32	PR/DIN/AC - PR/DIN/AS - PR/DIN/AL
Replacement relay (1)	Cat. No. 8904002
Screw type jumper	red white blue



# 24 Vac/dc DPDT relay modules universal control voltage

- DC and AC control voltage
- Positive or negative control voltage
- Status LED display
- Pluggable relay

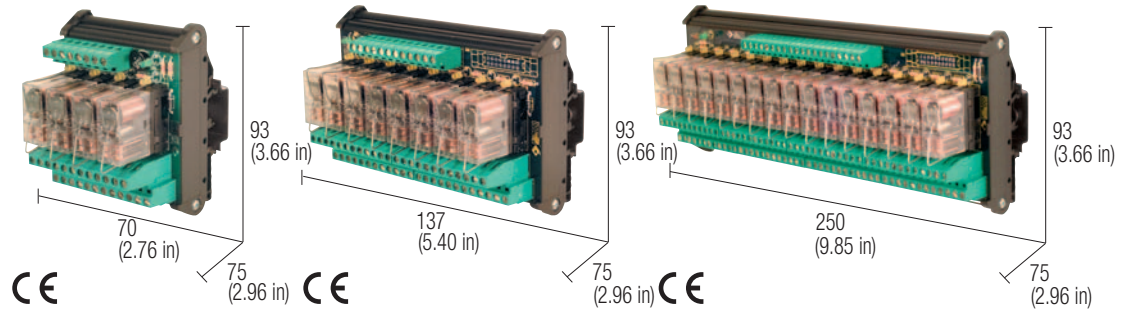

## NOTES

The height dimension includes 35 mm DIN rail.  
 (1) Relay model is not binding, they may be modified without prior warning. The technical data shown here is to be considered typical.  
 (2) Version available upon request.

### POWER SUPPLY

A1 = +	A2 = -	negative common
A1 = -	A2 = +	positive common
A1 = ~	A2 = ~	AC power supply

## BLOCK DIAGRAM

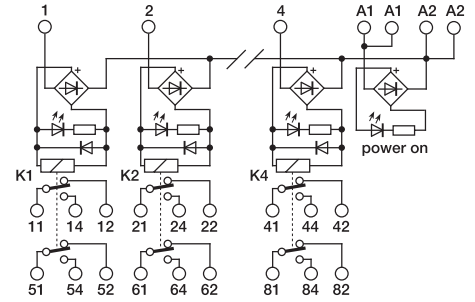

4 relay module

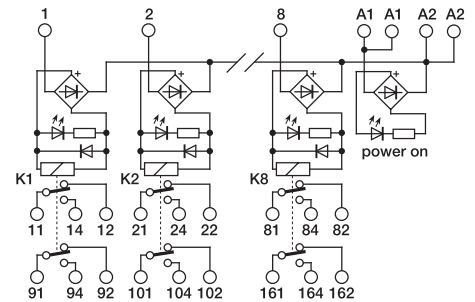

8 relay module

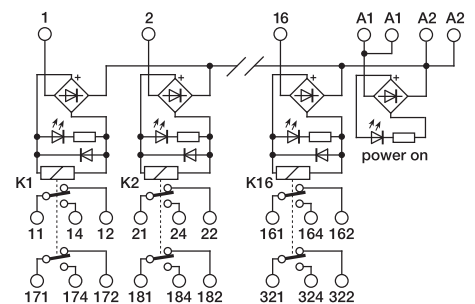

16 relay module

## VERSIONS

4 relay module

8 relay module

16 relay module

Cat. No. XR042EAD	Cat. No. XR082EAD	Cat. No. XR162EAD
R42EAD	R82EAD	R162EAD

## INPUT TECHNICAL DATA

Rated voltage	24 Vac/dc $\pm 10\%$
Rated current (1 channel)	22 mA $\pm 10\%$
Turn ON time	15 ms
Turn OFF time	5 ms
Protection circuit	damping diode and bridge rectifier

## OUTPUT TECHNICAL DATA

Type and number of contacts	DPDT AgNi
Nominal load (resistive)	8 A / 250 Vac
Current breaking power	8 A
Current of the fuse max.	—

## GENERAL TECHNICAL DATA

Operating temperature range	-10...+50°C
Coil/contact isolation	2.5 kVac / 60 s
Isolation between output terminals	1 kVac / 60 s (between open contact)
Protection degree	IP 00 IEC 529, EN60529
Overvoltage category / Pollution degree	III / 2
Reference Standard	IEC 664-1, DIN VDE 0110.1
Status display	green LED / yellow LED
Connection terminal	2.5 mm <sup>2</sup> fixed screw type
Housing material	UL94V-0 plastic material
Approx. weight	227 g (8.01 oz)   427 g (15.07 oz)   835 g (29.48 oz)
Mounting information	vertical on rail adjacent without gap

## MOUNTING ACCESSORIES

Mounting rail type according to IEC60715/TH35	PR/3/AC, PR/3/AC/ZB, PR/3/AS, PR/3/AS/ZB
Mounting rail type according to IEC60715/G32	PR/DIN/AC - PR/DIN/AS - PR/DIN/AL
Replacement relay (1)	Cat. No. 8904002
Screw type jumper	red white blue

# 24 Vac/dc relay modules universal control voltage with test push button

- DC control voltage
- Positive or negative control voltage
- Status LED display
- Pluggable relay
- Test with push button and micro switch

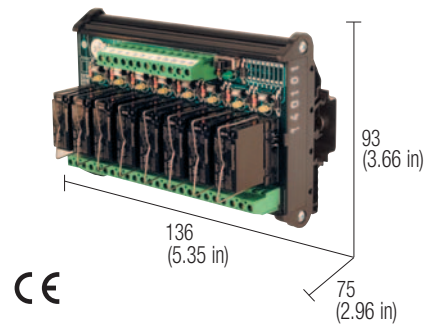

## NOTES

The height dimension includes 35 mm DIN rail.  
 (1) Relay model is not binding, they may be modified without prior warning. The technical data shown here is to be considered typical.  
 (2) They replace XRP08124 and XRD08124 models.

### POWER SUPPLY

A1 = +	A2 = -	negative common
A1 = -	A2 = +	positive common
A1 = ~	A2 = ~	AC power supply

## BLOCK DIAGRAM

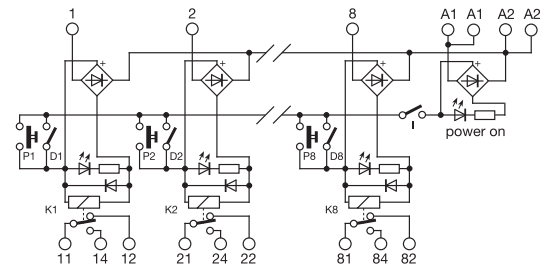

- P = test button
- D = dip-switch
- IG = master switch (disable the push button and dip-switch)

## VERSIONS

Con pulsante e dip switch

Cat. No. XRMP081CM (2)

RMPO81CM

## INPUT TECHNICAL DATA

Rated voltage	24 Vac/dc ± 10%
Rated current (1 channel)	22 mA ± 10%
Turn ON time	15 ms
Turn OFF time	5 ms
Protection circuit	damping diode and bridge rectifier

## OUTPUT TECHNICAL DATA

Type and number of contacts	SPDT AgSnO <sub>2</sub> per 8 relé
Nominal load (resistive)	12 A / 250 Vac
Current breaking power	12 A
Current of the fuse max.	—

## GENERAL TECHNICAL DATA

Operating temperature range	-10...+50°C
Coil/contact isolation	2.5 kVac / 60 s
Isolation between output terminals	1 kVac / 60 s (between open contact)
Protection degree	IP 00 IEC 529, EN60529
Overtoltage category / Pollution degree	III / 2
Reference Standard	IEC 664-1, DIN VDE 0110.1
Status display	green LED / yellow LED
Connection terminal	2.5 mm <sup>2</sup> fixed screw type
Housing material	UL94V-0 plastic material
Approx. weight	350 g (12.36 oz)
Mounting information	vertical on rail adjacent without gap

## MOUNTING ACCESSORIES

Mounting rail type according to IEC60715/TH35	PR/3/AC, PR/3/AC/ZB, PR/3/AS, PR/3/AS/ZB
Mounting rail type according to IEC60715/G32	PR/DIN/AC - PR/DIN/AS - PR/DIN/AL
Replacement relay (1)	Cat. No. 8904001
Screw type jumper	red —
	white —
	blue —

This series of products allows piloting with alternating and direct current, in which case only positive control is possible. We also recommend cutting JP jumpers if piloting takes place via low-current devices (e.g. proximity sensors).

On both versions it is possible the temporary turn on of the relay by pushing the relative button.

On model RD08124 it is possible to switch on the relays permanently with a Dip-Switch.

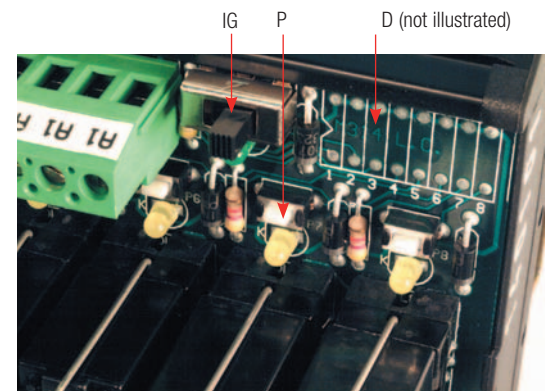

# 110...120 Vac/dc SPDT relay modules universal control voltage

- DC and AC control voltage
- Positive or negative control voltage
- Status LED display
- Pluggable relay

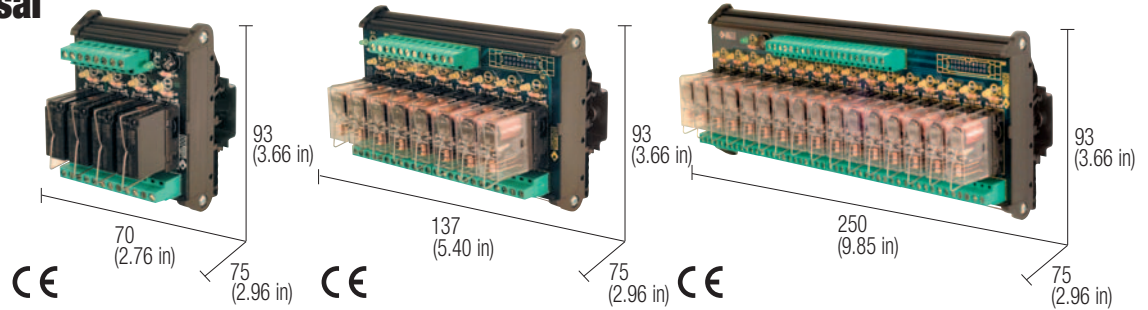

## NOTES

The height dimension includes 35 mm DIN rail.  
 (1) Relay model is not binding, they may be modified without prior warning. The technical data shown here is to be considered typical.

**Article available until sell-out**

**With 110 Vdc rated voltage:**

- replace XR041E11A with no.4 XCM1C110 and no.1 XCMB16B
- replace XR081E11A with no.8 XCM1C110 and no.1 XCMB16B
- replace XR161E11A with no.16 XCM1C110 and no.2 XCMB16B

**With 120 Vac rated voltage:**

- replace XR041E11A with no.4 XCM1A120 and no.1 XCMB16B
- replace XR081E11A with no.8 XCM1A120 and no.1 XCMB16B
- replace XR161E11A with no.16 XCM1A120 and no.2 XCMB16B

## BLOCK DIAGRAM

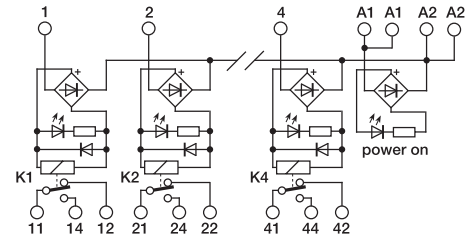

4 relay module

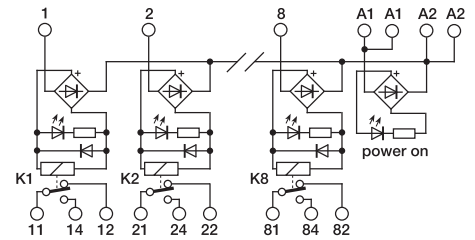

8 relay module

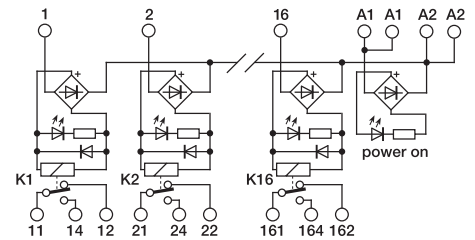

16 relay module

POWER SUPPLY		
A1 = +	A2 = -	negative common
A1 = -	A2 = +	positive common
A1 = ~	A2 = ~	AC power supply

## VERSIONS

4 relay module

8 relay module

16 relay module

Cat. No. XR041E1A	Cat. No. XR081E1A	Cat. No. XR161E1A
R41E11A	R81E11A	R161E11A

## INPUT TECHNICAL DATA

Rated voltage	110 Vdc / 120 Vac $\pm$ 10%
Rated current (1 channel)	11 mA $\pm$ 10%
Turn ON time	7 ms
Turn OFF time	3 ms
Protection circuit	damping diode and bridge rectifier

## OUTPUT TECHNICAL DATA

Type and number of contacts	SPDT AgNi
Nominal load (resistive)	12 A / 250 Vac
Current breaking power	12 A
Current of the fuse max.	—

## GENERAL TECHNICAL DATA

Operating temperature range	-10...+50°C
Coil/contact isolation	2.5 kVac / 60 s
Isolation between output terminals	1 kVac / 60 s (between open contact)
Protection degree	IP 00 IEC 529, EN60529
Overtoltage category / Pollution degree	III / 2
Reference Standard	IEC 664-1, DIN VDE 0110.1
Status display	green LED / yellow LED
Connection terminal	2.5 mm <sup>2</sup> fixed screw type
Housing material	UL94V-0 plastic material
Approx. weight	192 g (6.76 oz)   345 g (12.18 oz)   688 g (24.29 oz)
Mounting information	vertical on rail adjacent without gap

## MOUNTING ACCESSORIES

Mounting rail type according to IEC60715/TH35	PR/3/AC, PR/3/AC/ZB, PR/3/AS, PR/3/AS/ZB
Mounting rail type according to IEC60715/G32	PR/DIN/AC - PR/DIN/AS - PR/DIN/AL
Replacement relay (1)	Cat. No. 8904047
Screw type jumper	red — white — blue —

# 230 Vac SPDT relay modules

- AC control voltage
- Status LED display
- Pluggable relay

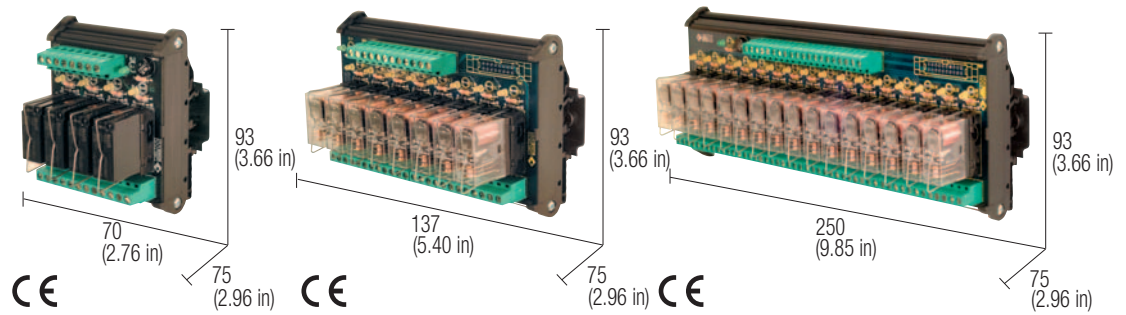

## NOTES

The height dimension includes 35 mm DIN rail.  
 (1) Relay model is not binding, they may be modified without prior warning. The technical data shown here is to be considered typical.

Article available until sell-out  
 replace XR041E22A with no.4 XCM1A230 and no.1 XCMB16B  
 replace XR081E22A with no.8 XCM1A230 and no.1 XCMB16B  
 replace XR161E22A with no.16 XCM1A230 and no.2 XCMB16B

## BLOCK DIAGRAM

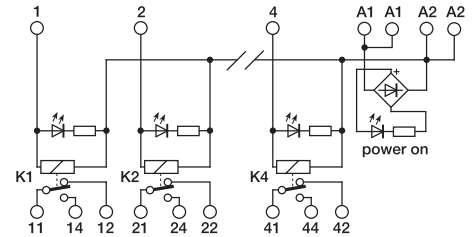

4 relay module

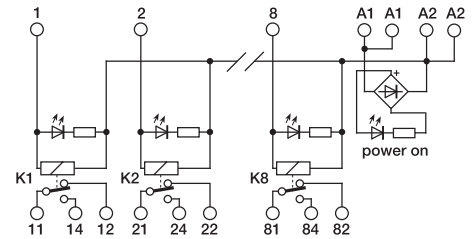

8 relay module

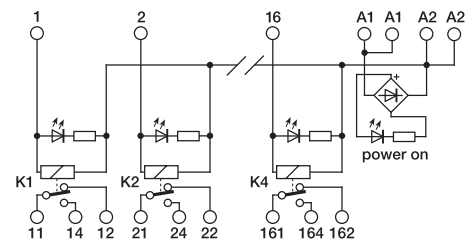

16 relay module

## VERSIONS

- 4 relay module
- 8 relay module
- 16 relay module

Cat. No. XR041E2A	Cat. No. XR081E2A	Cat. No. XR161E2A
R41E22A	R81E22A	R161E22A

## INPUT TECHNICAL DATA

Rated voltage	230 Vac $\pm$ 10%
Rated current (1 channel)	10 mA $\pm$ 10%
Turn ON time	7 ms
Turn OFF time	2 ms
Protection circuit	—

## OUTPUT TECHNICAL DATA

Type and number of contacts	SPDT AgSnO <sub>2</sub>
Nominal load (resistive)	12 A / 250 Vac
Current breaking power	12 A
Current of the fuse max.	—

## GENERAL TECHNICAL DATA

Operating temperature range	-10...+50°C
Coil/contact isolation	2.5 kVac / 60 s
Isolation between output terminals	1 kVac / 60 s (between open contact)
Protection degree	IP 00 IEC 529, EN60529
Overtoltage category / Pollution degree	III / 2
Reference Standard	IEC 664-1, DIN VDE 0110.1
Status display	green LED / yellow LED
Connection terminal	2.5 mm <sup>2</sup> fixed screw type
Housing material	UL94V-0 plastic material
Approx. weight	192 g (6.76 oz)   345 g (12.18 oz)   688 g (24.29 oz)
Mounting information	vertical on rail adjacent without gap

## MOUNTING ACCESSORIES

Mounting rail type according to IEC60715/TH35	PR/3/AC, PR/3/AC/ZB, PR/3/AS, PR/3/AS/ZB
Mounting rail type according to IEC60715/G32	PR/DIN/AC - PR/DIN/AS - PR/DIN/AL
Replacement relay (1)	Cat. No. 8904050
Screw type jumper	red white blue

# Super compact 24 Vac/dc relay modules universal control voltage

- 3 kV I/O isolation
- 1 kV isolation between output contact
- Fast connection with pluggable terminals
- DC and AC control voltage
- Positive or negative control voltage

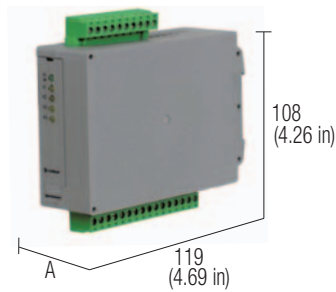

A = 22.5 mm (0.88 in) CR version, 35 mm (1.38 in) CRE version

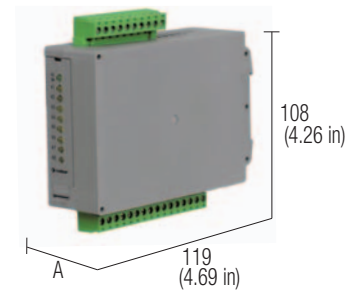

A = 22.5 mm (0.88 in) CR version, 35 mm (1.38 in) CRE version

## NOTES

The height dimension includes 35 mm DIN rail.  
 (1) Relay model is not binding, they may be modified without prior warning. The technical data shown here is to be considered typical.  
**CR4-1** and **CRE4-1**: relay module with SPDT, inputs and outputs with pluggable terminals.  
**CR8-1** and **CRE8-1**: 8 relay module with SPST (NO), inputs and outputs with pluggable terminals.

## BLOCK DIAGRAM

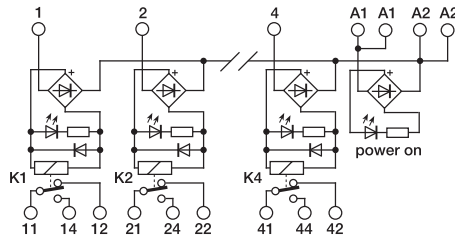

## BLOCK DIAGRAM

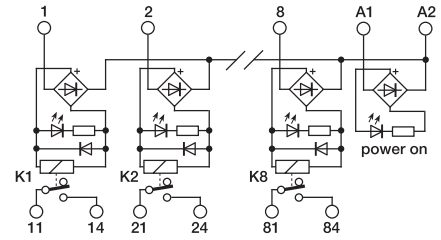

## VERSIONS

Pluggable relay  
 Fixed relay

Cat. No. XCRE41	Cat. No. XCR4
CRE4-1	CR4-1

Cat. No. XCRE81	Cat. No. XCR81
CRE8-1	CR8-1

## INPUT TECHNICAL DATA

Rated voltage	24 Vac/dc ± 10%
Rated current (1 channel)	16 mA ± 10%
Turn ON time	7 ms
Turn OFF time	3 ms
Protection circuit	damping diode and bridge rectifier

Rated voltage	24 Vac/dc ± 10%
Rated current (1 channel)	16 mA ± 10%
Turn ON time	7 ms
Turn OFF time	3 ms
Protection circuit	damping diode and bridge rectifier

Rated voltage	24 Vac/dc ± 10%
Rated current (1 channel)	16 mA ± 10%
Turn ON time	7 ms
Turn OFF time	3 ms
Protection circuit	damping diode and bridge rectifier

## OUTPUT TECHNICAL DATA

Type and number of contacts	SPDT AgNiO per 4 relé
Nominal load (resistive)	8 A / 250 Vac
Current breaking power	2000 VA
Current of the fuse max.	—

Type and number of contacts	SPDT AgNiO per 4 relé
Nominal load (resistive)	8 A / 250 Vac
Current breaking power	2000 VA
Current of the fuse max.	—

Type and number of contacts	SPST(NO) per 8 relay
Nominal load (resistive)	8 A / 250 Vac
Current breaking power	2000 VA
Current of the fuse max.	—

## GENERAL TECHNICAL DATA

Operating temperature range	-10...+50°C
Coil/contact isolation	2.5 kVac / 60 s
Isolation between output terminals	1 kVac / 60 s (between open contact)
Protection degree	IP 20 IEC 529, EN60529
Overtoltage category / Pollution degree	III / 2
Reference Standard	IEC 664-1, DIN VDE 0110.1
Status display	green LED / yellow LED
Connection terminal	2.5 mm <sup>2</sup> fixed screw type
Housing material	UL94V-0 plastic material
Approx. weight	143 g (5.05 oz) (180 g [6.35 oz] pluggable version)
Mounting information	vertical on rail adjacent without gap

Operating temperature range	-10...+50°C
Coil/contact isolation	2.5 kVac / 60 s
Isolation between output terminals	1 kVac / 60 s (between open contact)
Protection degree	IP 20 IEC 529, EN60529
Overtoltage category / Pollution degree	III / 2
Reference Standard	IEC 664-1, DIN VDE 0110.1
Status display	green LED / yellow LED
Connection terminal	2.5 mm <sup>2</sup> fixed screw type
Housing material	UL94V-0 plastic material
Approx. weight	143 g (5.05 oz) (180 g [6.35 oz] pluggable version)
Mounting information	vertical on rail adjacent without gap

Operating temperature range	-10...+50°C
Coil/contact isolation	3 kVac / 60 s
Isolation between output terminals	1 kVac / 60 s (between open contact)
Protection degree	IP 20 IEC 529, EN60529
Overtoltage category / Pollution degree	III / 2
Reference Standard	IEC 664-1, DIN VDE 0110.1
Status display	green LED / yellow LED
Connection terminal	2.5 mm <sup>2</sup> fixed screw type
Housing material	UL94V-0 plastic material
Approx. weight	199 g (7.02 oz) (250 g [8.83 oz] pluggable version)
Mounting information	vertical on rail adjacent without gap

## MOUNTING ACCESSORIES

Mounting rail type according to IEC60715/TH35	PR/3/AC, PR/3/AC/ZB, PR/3/AS, PR/3/AS/ZB
Mounting rail type according to IEC60715/G32	PR/DIN/AC - PR/DIN/AS - PR/DIN/AL
Replacement relay (1)	Cat. No. 8904042
Screw type jumper	red white blue

Mounting rail type according to IEC60715/TH35	PR/3/AC, PR/3/AC/ZB, PR/3/AS, PR/3/AS/ZB
Mounting rail type according to IEC60715/G32	PR/DIN/AC - PR/DIN/AS - PR/DIN/AL
Replacement relay (1)	Cat. No. 8904042
Screw type jumper	— — —

Mounting rail type according to IEC60715/TH35	PR/3/AC, PR/3/AC/ZB, PR/3/AS, PR/3/AS/ZB
Mounting rail type according to IEC60715/G32	PR/DIN/AC - PR/DIN/AS - PR/DIN/AL
Replacement relay (1)	Cat. No. 8904042
Screw type jumper	— — —



# Super compact 24 Vac/dc relay modules universal control voltage

- 3 kV I/O isolation
- 1 kV isolation between output contact
- Fast connection with pluggable terminals
- DC and AC control voltage
- Positive or negative control voltage

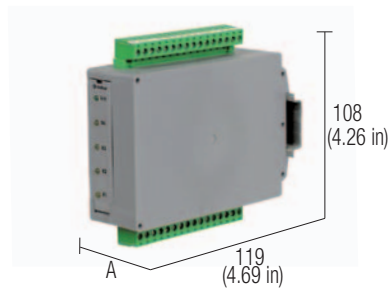

A = 22.5 mm (0.88 in) CR version, 35 mm (1.38 in) CRE version

## NOTES

The height dimension includes 35 mm DIN rail.  
 (1) Relay model is not binding, they may be modified without prior warning. The technical data shown here is to be considered typical  
 (2) Version available upon request; for information call our sales department, local agent or representative

## BLOCK DIAGRAM

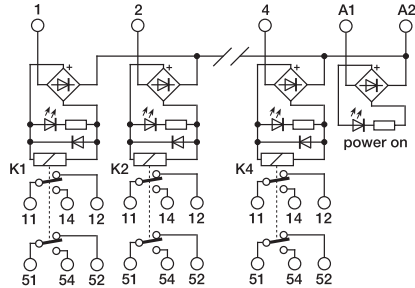

## VERSIONS

Pluggable relay  
 Fixed relay

Cat. No. XCRE42SC  
 CRE4-2SC (2)

Cat. No. XCR42SC  
 CR4-2SC (2)

## INPUT TECHNICAL DATA

Rated voltage	24 Vac/dc ± 10%
Rated current (1 channel)	25 mA ± 10%
Turn ON time	7 ms
Turn OFF time	2 ms
Protection circuit	damping diode and bridge rectifier

## OUTPUT TECHNICAL DATA

Type and number of contacts	DPDT AgNi per 4 relé
Nominal load (resistive)	8 A / 250 Vac
Current breaking power	2000 VA
Current of the fuse max.	—

## GENERAL TECHNICAL DATA

Operating temperature range	-10...+50°C
Coil/contact isolation	2.5 kVac / 60 s
Isolation between output terminals	1 kVac / 60 s (between open contact)
Protection degree	IP 20 IEC 529, EN60529
Overtoltage category / Pollution degree	III / 2
Reference Standard	IEC 664-1, DIN VDE 0110.1
Status display	green LED / yellow LED
Connection terminal	2.5 mm <sup>2</sup> fixed screw type
Housing material	UL94V-0 plastic material
Approx. weight	137 g (180 g pluggable version)
Mounting information	vertical on rail adjacent without gap

## MOUNTING ACCESSORIES

Mounting rail type according to IEC60715/TH35	PR/3/AC, PR/3/AC/ZB, PR/3/AS, PR/3/AS/ZB
Mounting rail type according to IEC60715/G32	PR/DIN/AC - PR/DIN/AS - PR/DIN/AL
Replacement relay (1)	Cat. No. 8904052
Screw type jumper	—
red	—
white	—
blue	—

# PLC interface modules quick selection table

These tables allow you to quickly select only the items, then check if all product's technical data meet your application requirements.

## Input modules

Number of channels	Connection type	Notes	Type	Cat. No.	Page
8 without isolation	12 Vdc	(1) (4)	IF16S7	XIF16S7	125
8 without isolation	12 Vdc	(1) (3)	IF16LS7	XIF16LS7	125
32 without isolation	12 Vdc	(1) (4)	IF416S7	XIF416S7	125
32 without isolation	12 Vdc	(1) (3)	IF416LS7	XIF416LS7	125

## Output modules

Number of channels	Input voltage	Output		Notes	Type	Cat. No.	Page
		type / no. of contacts	rated current				
8	24 Vdc	SPST(NO)	8 A	(1) (3) (5)	CR8-3	XCR83	126
8	24 Vdc	SPST(NO)	8 A	(1) (3) (5)	CRE8-3	XCRE83	126
8	24 Vdc	SPDT	10 A	(1) (3) (5)	RFE8124	XRFE8124	126
8	24 Vdc	DPDT	5 A	(1) (3) (5)	RFE8224	XRFE8224	127
16	24 Vdc	SPDT	10 A	(2) (3) (5)	RFE16124	XRFE16124	128
16	24 Vdc	DPDT	5 A	(2) (3) (5)	RFE16224	XRFE16224	128

### Notes

- (1) suitable for PLC Siemens S7 series
- (2) suitable for PLC Telemecanique
- (3) with LED to display the status

- (4) without LED to display the status
- (5) version with pluggable relay

# PLC S7 300 & S7 400 Interface modules

- I/O modules
- With or without status LED display
- Fast connection

Item available till sell-out

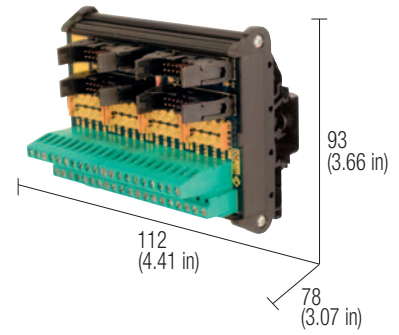
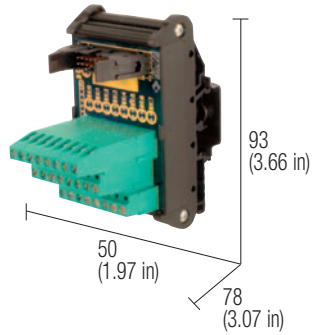

## NOTES

(1) Relay model is not binding, they may be modified without prior warning. The technical data shown here is to be considered typical.  
 (2) Version available upon request; for information call our sales department, local agent or representative

## BLOCK DIAGRAM

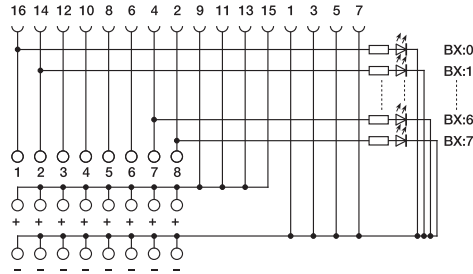

## BLOCK DIAGRAM

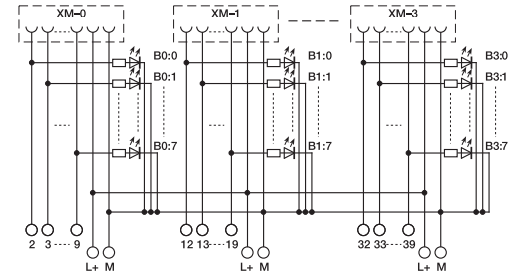

## VERSIONS

- With LED to display the status
- Without LED to display the status

Cat. No. XIF16S7

IF16S7 (2)

Cat. No. XIF416LS7

IF416LS7 (2)

Cat. No. XIF416S7

IF416S7 (2)

## INPUT TECHNICAL DATA

Rated voltage	24 Vdc ± 10%
Rated current (1 channel)	5 mA ± 10% (only with "Status LED" version)
Turn ON time	—
Turn OFF time	—
Protection circuit	—

Rated voltage	24 Vdc ± 10%
Rated current (1 channel)	5 mA ± 10% (only with "Status LED" version)
Turn ON time	—
Turn OFF time	—
Protection circuit	—

## OUTPUT TECHNICAL DATA

Type and number of contacts	8 channels without isolation
Nominal load (resistive)	—
Current breaking power	—
Current of the fuse max.	—

Type and number of contacts	4 x 8 channels without isolation
Nominal load (resistive)	—
Current breaking power	—
Current of the fuse max.	—

## GENERAL TECHNICAL DATA

Operating temperature	-10...+50°C
Coil/contact isolation	—
Isolation between output terminals	—
Protection degree	IP 00 IEC529, EN60529
Overtoltage category / Pollution degree	II / 2
Reference Standard	IEC 664-1
Status display	LED (solo su IF16LS7)
Connection terminals	flat cable 16 poles male and 2.5 mm <sup>2</sup> fixed screw ty'e
Housing material	polyamide UL94V-0
Approx. weight	—
Mounting information	—

Operating temperature	-10...+50°C
Coil/contact isolation	—
Isolation between output terminals	—
Protection degree	IP 00 IEC529, EN60529
Overtoltage category / Pollution degree	II / 2
Reference Standard	IEC 664-1
Status display	LED (solo su IF416LS7)
Connection terminals	flat cable 16 poles male and 2.5 mm <sup>2</sup> fixed screw ty'e
Housing material	polyamide UL94V-0
Approx. weight	—
Mounting information	—

## MOUNTING ACCESSORIES

Mounting rail type according to IEC60715/TH35	PR/3/AC, PR/3/AS
Mounting rail type according to IEC60715/G32	PR/DIN/AC - PR/DIN/AS - PR/DIN/AL
Replacement relay (1)	—
Screw type jumper	red white blue

Mounting rail type according to IEC60715/TH35	PR/3/AC, PR/3/AS
Mounting rail type according to IEC60715/G32	PR/DIN/AC - PR/DIN/AS - PR/DIN/AL
Replacement relay (1)	—
Screw type jumper	red white blue

# PLC S7 300 & S7 400 Interface modules

- Very compact dimension in CR version
- Fast connection
- Pluggable relay
- Status LED display

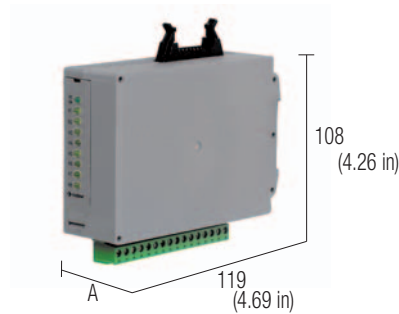

A = 22.5 mm (0.88 in) CR version, 35 mm (1.38 in) CRE version

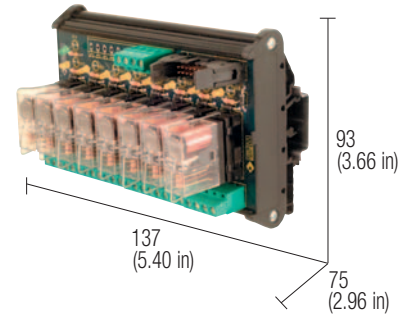

CE **Item available until sell-out will be replaced by XR081E24**

## NOTES

- (1) Relay model is not binding, they may be modified without prior warning. The technical data shown here is to be considered typical.  
 (2) Version available upon request.

## BLOCK DIAGRAM

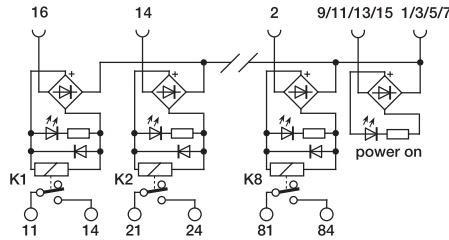

## BLOCK DIAGRAM

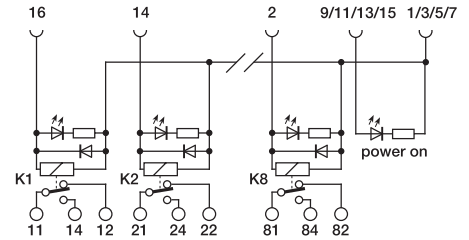

## VERSIONS

Pluggable relay  
Fixed relay

Cat. No. XCRE83	Cat. No. XCR83
CRE8-3	CR8-3

Cat. No. XRF8124

RFE8124

## INPUT TECHNICAL DATA

Rated voltage	24 Vac/dc ± 10%
Rated current (1 channel)	16 mA ± 10%
Turn ON time	15 ms
Turn OFF time	5 ms
Protection circuit	damping diode and bridge rectifier

Rated voltage	24 Vac/dc ± 10%
Rated current (1 channel)	20 mA ± 10%
Turn ON time	15 ms
Turn OFF time	10 ms
Protection circuit	damping diode and bridge rectifier

## OUTPUT TECHNICAL DATA

Type and number of contacts	SPST(NO) per 8 relay
Nominal load (resistive)	10 A / 250 Vac
Current breaking power	2000 VA
Current of the fuse max.	—

Type and number of contacts	SPDT AgNiO per 8 relé
Nominal load (resistive)	10 A / 250 Vac
Current breaking power	10 A
Current of the fuse max.	—

## GENERAL TECHNICAL DATA

Operating temperature range	-10...+50°C
Coil/contact isolation	3 kVac / 60 s
Isolation between output terminals	1 kVac / 60 s (between open contact)
Protection degree	IP 20 IEC 529, EN60529
Overtoltage category / Pollution degree	III / 2
Reference Standard	IEC 664-1, DIN VDE 0110.1
Status display	green LED / yellow LED
Connection terminal	flat cable 16 poles male
Housing material	UL94V-0 plastic material
Approx. weight	199 g (7.02 oz)
Mounting information	vertical on rail adjacent without gap

Operating temperature range	-10...+50°C
Coil/contact isolation	2.5 kVac / 60 s
Isolation between output terminals	1 kVac / 60 s (between open contact)
Protection degree	IP 00 IEC 529, EN60529
Overtoltage category / Pollution degree	III / 2
Reference Standard	IEC 664-1, DIN VDE 0110.1
Status display	green LED / yellow LED
Connection terminal	flat cable 16 poles male and 2.5 mm <sup>2</sup> fixed screw ty/e
Housing material	UL94V-0 plastic material
Approx. weight	342 g (12.07 oz)
Mounting information	vertical on rail adjacent without gap

## MOUNTING ACCESSORIES

Mounting rail type according to IEC60715/TH35	PR/3/AC, PR/3/AC/ZB, PR/3/AS, PR/3/AS/ZB
Mounting rail type according to IEC60715/G32	—
Replacement relay (1)	Cat. No. 8904042
Screw type jumper	—
red	—
white	—
blue	—

PR/3/AC, PR/3/AC/ZB, PR/3/AS, PR/3/AS/ZB  
 PR/DIN/AC - PR/DIN/AS - PR/DIN/AL  
 Cat. No. 8904001

# PLC S7 300 & S7 400 Interface modules

- DC control voltage
- Negative control voltage
- Status LED display
- Pluggable relay
- Fast connection

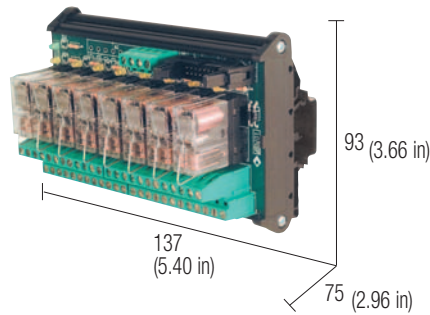

CE **Item available until sell-out  
will be replaced by XR082E24**

## NOTES

(1) Relay model is not binding, they may be modified without prior warning. The technical data shown here is to be considered typical.  
(2) Version available upon request.

## BLOCK DIAGRAM

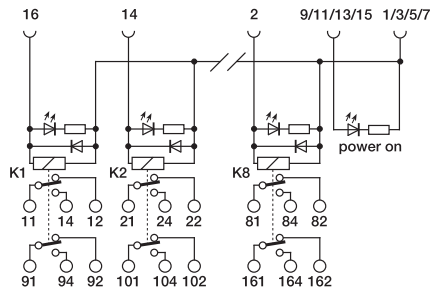

## VERSIONS

Pluggable relay  
Fixed relay

Cat. No. XRFE8224

RFE8224

## INPUT TECHNICAL DATA

Rated voltage	24 Vdc ± 10%
Rated current (1 channel)	20 mA ± 10%
Turn ON time	15 ms
Turn OFF time	5 ms
Protection circuit	damping and polarity protection diode

## OUTPUT TECHNICAL DATA

Type and number of contacts	DPDT AgNiO per 8 relé
Nominal load (resistive)	5 A / 250 Vac
Current breaking power	5 A
Current of the fuse max.	—

## GENERAL TECHNICAL DATA

Operating temperature range	-10...+50°C
Coil/contact isolation	2.5 kVac / 60 s
Isolation between output terminals	1 kVac / 60 s (between open contact)
Protection degree	IP 00 IEC 529, EN60529
Overtoltage category / Pollution degree	III / 2
Reference Standard	IEC 664-1, DIN VDE 0110.1
Status display	green LED / yellow LED
Connection terminal	flat cable 16 poles male and 2.5 mm <sup>2</sup> fixed screw type
Housing material	UL94V-0 plastic material
Approx. weight	419 g (14.79 oz)
Mounting information	vertical on rail adjacent without gap

## MOUNTING ACCESSORIES

Mounting rail type according to IEC60715/TH35	PR/3/AC, PR/3/AC/ZB, PR/3/AS, PR/3/AS/ZB
Mounting rail type according to IEC60715/G32	PR/DIN/AC - PR/DIN/AS - PR/DIN/AL
Replacement relay (1)	Cat. No. 8904002
Screw type jumper	—
red	—
white	—
blue	—



# Telemecanique PLC interface modules

- DC control voltage
- Negative control voltage
- Status LED display
- Pluggable relay
- Fast connection

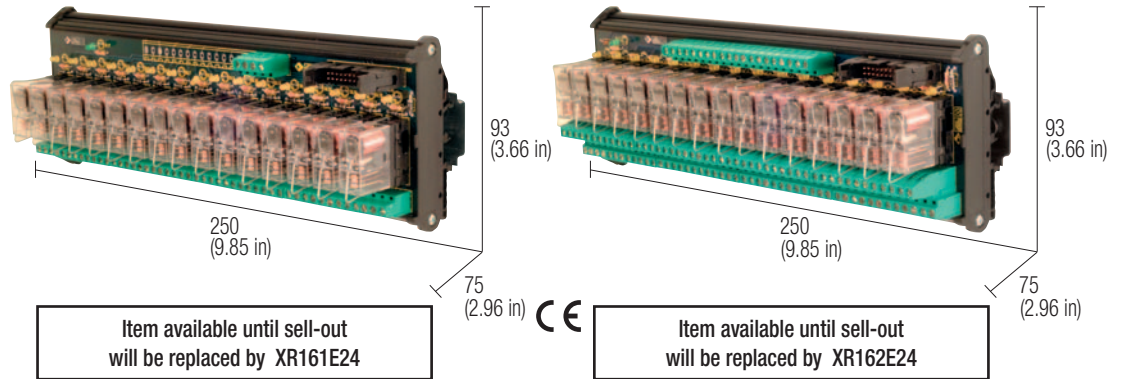

## NOTES

(1) Relay model is not binding, they may be modified without prior warning. The technical data shown here is to be considered typical.

## BLOCK DIAGRAM

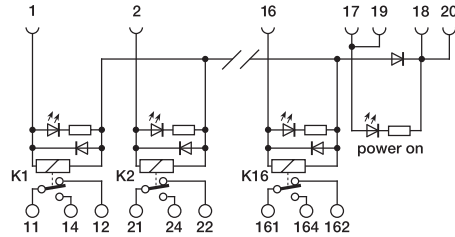

## BLOCK DIAGRAM

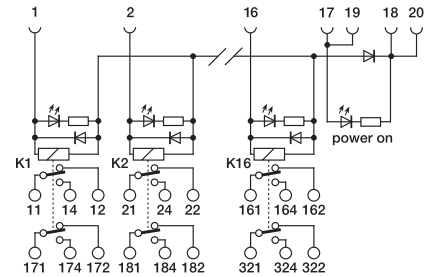

## VERSIONS

Pluggable relay  
Fixed relay

Cat. No. XRFE16124

RFE16124

—

Cat. No. XRFE16224

RFE16224

—

## INPUT TECHNICAL DATA

Rated voltage	24 Vdc ± 10%
Rated current (1 channel)	20 mA ± 10%
Turn ON time	15 ms
Turn OFF time	5 ms
Protection circuit	damping and polarity protection diode

Rated voltage	24 Vdc ± 10%
Rated current (1 channel)	20 mA ± 10%
Turn ON time	15 ms
Turn OFF time	5 ms
Protection circuit	damping and polarity protection diode

## OUTPUT TECHNICAL DATA

Type and number of contacts	SPDT AgNiO per 16 relé
Nominal load (resistive)	10 A / 250 Vac
Current breaking power	10 A
Current of the fuse max.	—

Type and number of contacts	DPDT AgNiO per 16 relé
Nominal load (resistive)	5 A / 250 Vac
Current breaking power	5 A
Current of the fuse max.	—

## GENERAL TECHNICAL DATA

Operating temperature range	-10...+50°C
Coil/contact isolation	2.5 kVac / 60 s
Isolation between output terminals	1 kVac / 60 s (between open contact)
Protection degree	IP 00 IEC 529, EN60529
Overtoltage category / Pollution degree	III / 2
Reference Standard	IEC 664-1, DIN VDE 0110.1
Status display	green LED / yellow LED
Connection terminal	flat cable 16 poles male and 2.5 mm <sup>2</sup> fixed screw ty'e
Housing material	UL94V-0 plastic material
Approx. weight	657 g (23.19 oz)
Mounting information	vertical on rail adjacent without gap

Operating temperature range	-10...+50°C
Coil/contact isolation	2.5 kVac / 60 s
Isolation between output terminals	1 kVac / 60 s (between open contact)
Protection degree	IP 00 IEC 529, EN60529
Overtoltage category / Pollution degree	III / 2
Reference Standard	IEC 664-1, DIN VDE 0110.1
Status display	green LED / yellow LED
Connection terminal	flat cable 16 poles male and 2.5 mm <sup>2</sup> fixed screw ty'e
Housing material	UL94V-0 plastic material
Approx. weight	811 g (28.63 oz)
Mounting information	vertical on rail adjacent without gap

## MOUNTING ACCESSORIES

Mounting rail type according to IEC60715/TH35	PR/3/AC, PR/3/AC/ZB, PR/3/AS, PR/3/AS/ZB
Mounting rail type according to IEC60715/G32	PR/DIN/AC - PR/DIN/AS - PR/DIN/AL
Replacement relay (1)	Cat. No. 8904001
Screw type jumper	—
red	—
white	—
blue	—

PR/3/AC, PR/3/AC/ZB, PR/3/AS, PR/3/AS/ZB  
PR/DIN/AC - PR/DIN/AS - PR/DIN/AL  
Cat. No. 8904002

# Solid state relay modules quick selection table

These tables allow you to quickly select only the items, then check if all product's technical data meet your application requirements.

## Input modules

Number of channels	Input voltage	Applicable load		Notes	Type	Cat. No.	Page
		Voltage	Current				
1	5...24 Vdc	5...48 Vdc	3 A	(2)	O332060	XO332060	130
1	5...24 Vdc	5...48 Vdc	500 mA	(2)	CWOT 6-2082	X766082	136
1	12...24 Vdc	5...48 Vdc	500 mA	(2)	CWOT 6-2083	X766083	135
1	12...24 Vdc	5...48 Vdc	5 A	(1)	CM1S024E	XCM1S024E	131
1	24 Vdc	5...48 Vdc	2 A	(1)	CM1S024	XCM1S024	131
1	5...12 Vdc	5...24 Vdc	5 A	(2) (4)	CKS15NA	XCKS15NA	133
1	5...24 Vdc	5...24 Vdc	30 mA	(2)	CKS1S	XCKS1S	136
1	24 Vdc	5...24 Vdc	5 A	(2) (4)	CKS15NB	XCKS15NB	133
1	5...24 Vdc	5...24 Vdc	5 A	(2) (5)	CKS15E	XCKS15E	134
1	12...24 Vdc	12...240 Vac	3 A	(1)	CM1T024E	XCM1T024E	132
1	5...24 Vdc	24...240 Vac	4 A	(2)	O332240	XO332240	130
1	24 Vdc	48...240 Vac	2 A	(1)	CM1T024	XCM1T024	132
2	12...24 Vdc	12...24 Vdc	2 x 2.5 A	(2)	CKS22	XCKS22	134
4	24 Vdc	5...48 Vdc	2 A	(1) (3) (4)	R41S24F	XR041S24F	139
4	24 Vdc	5...48 Vdc	2 A	(1) (3)	R42S24	XR042S24	137
4	24 Vdc	48...240 Vac	2 A	(1) (3)	R42T24	XR042T24	138
8	24 Vdc	5...48 Vdc	2 A	(1) (3) (4)	R81S24F	XR081S24F	139
8	24 Vdc	5...48 Vdc	2 A	(1) (3)	R82S24	XR082S24	137
8	24 Vdc	48...240 Vac	2 A	(1) (3)	R82T24	XR082T24	138
8	5...24 Vdc	12...24 Vdc	8 x 2.5 A	(2) (5)	COP082	XCOP082	140
16	24 Vdc	5...48 Vdc	2 A	(1) (3) (4)	R161S24F	XR161S24F	139
16	24 Vdc	5...48 Vdc	2 A	(1) (3)	R162S24	XR162S24	137
16	24 Vdc	48...240 Vac	2 A	(1) (3)	R162T24	XR162T24	138

### Notes

(1) version with pluggable relay

(2) version with fixed relay

(3) universal control voltage, negative/positive DC command

(4) output contact with protection fuse

(5) electronic output protection

# Solid state 5...24 Vdc single relay

- Fixed relay
- Compact dimensions
- Status LED display

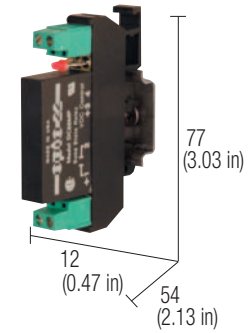
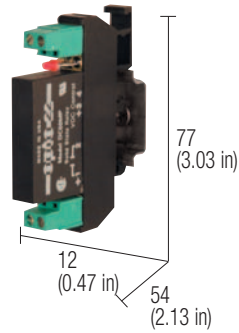

## NOTES

(1) Relay model is not binding, they may be modified without prior warning. The technical data shown here is to be considered typical.

## BLOCK DIAGRAM

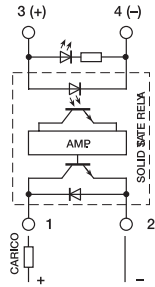

## BLOCK DIAGRAM

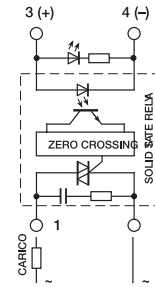

## VERSIONS

	Cat. No. X0332060	Cat. No. X0332240
Pluggable relay	—	—
Fixed relay	0332060	0332240

## INPUT TECHNICAL DATA

	X0332060	X0332240
Input voltage	4...30 Vdc	4...30 Vdc
Level 1 (high) input signal	> 3 Vdc	> 3 Vdc
Level 0 (low) input signal	< 1 Vdc	< 1 Vdc
Rated current	< 35 mA	< 35 mA
Switching frequency	100 Hz max	100 Hz max
Connection terminals	2.5 mm <sup>2</sup> fixed screw type	2.5 mm <sup>2</sup> fixed screw type

## OUTPUT TECHNICAL DATA

	X0332060	X0332240
Output voltage	5...60 Vdc	24...240 Vac (zero crossing)
Continuous load current	3 A a 20°C (see chart)	4 A a 20°C (see chart)
Max. current	4 A a 20°C (5 A / 5 s - 25 A / 10 ms)	5 A a 20°C (6 A / 5 s - 25 A / 10 ms)
Leakage current 0 signal	1 mA	5 mA
OFF/ON switching time	—	10 ms max
Protection circuit	diode	RC filter
Connection terminals	2.5 mm <sup>2</sup> fixed screw type	2.5 mm <sup>2</sup> fixed screw type

## GENERAL TECHNICAL DATA

	X0332060	X0332240
Operating temperature	-20...-60°C (see chart)	-20...-60°C (see chart)
I/O isolation (coil/contact)	4 kVac / 60 s	4 kVac / 60 s
Protection degree	IP 00 IEC529, EN60529	IP 00 IEC529, EN60529
Reference Standard	IEC 664-1, DIN VDE 0110.1	IEC 664-1, DIN VDE 0110.1
Pollution degree	2	2
Overvoltage category	III	III
Modello del relé (1)	OPT022	OPT022
Status display	LED	LED
Housing material	Polyamide UL94V-0	Polyamide UL94V-0
Approx. weight	36 g (1.27 oz)	36 g (1.27 oz)
Mounting information	vertical on rail, allow 4 mm spacing between adjacent components	vertical on rail, allow 4 mm spacing between adjacent components

## MOUNTING ACCESSORIES

	X0332060	X0332240
Mounting rail type according to IEC60715/TH35	PR/3/AC, PR/3/AS	PR/3/AC, PR/3/AS
Mounting rail type according to IEC60715/G32	PR/DIN/AC - PR/DIN/AS - PR/DIN/AL	PR/DIN/AC - PR/DIN/AS - PR/DIN/AL
Replacement relay (1)	—	—
Screw type jumper	—	—
	red	—
	white	—
	blue	—

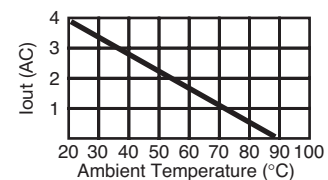
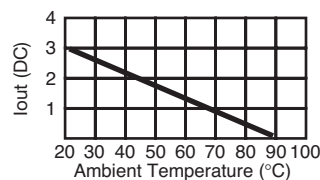

# Solid state 12-24 Vdc single relay

- Low cost
- For DC load (S version)
- Pluggable relay
- Screw type jumper available
- Status LED display

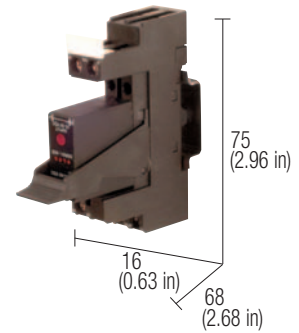
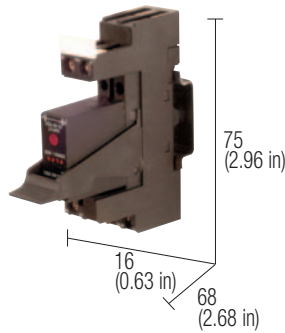

## NOTES

(1) Relay model is not binding, they may be modified without prior warning. The technical data shown here is to be considered typical.

(2) Version available upon request; for information call our sales department, local agent or representative

This series can be mounted without any spacing between adjacent components.

## BLOCK DIAGRAM

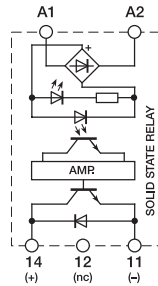

## BLOCK DIAGRAM

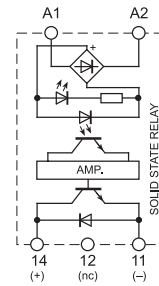

## VERSIONS

Pluggable relay  
Fixed relay

Cat. No. XCM1S024

CM1S024 (2)

Cat. No. XCM1S024E

CM1S024E (2)

## INPUT TECHNICAL DATA

Input voltage	<b>24 Vdc</b> (19.2...28.8 Vdc)
Level 1 (high) input signal	> 19.2 Vdc
Level 0 (low) input signal	< 1 Vdc
Rated current (1 channel)	< 20 mA
Switching frequency	100 Hz max
Connection terminals	2.5 mm <sup>2</sup> fixed screw type

Input voltage	<b>12-24 Vdc</b> (10...32 Vdc)
Level 1 (high) input signal	> 10 Vdc
Level 0 (low) input signal	< 9 Vdc
Rated current (1 channel)	< 13 mA
Switching frequency	100 Hz max
Connection terminals	2.5 mm <sup>2</sup> fixed screw type

## OUTPUT TECHNICAL DATA

Output voltage	<b>3...50 Vdc</b>
Continuous load current	<b>2 A</b> @ 40°C
Max. current	8 A / 10 ms
Leakage current 0 signal	0.1 mA
OFF/ON switching time	100 μs / 1 ms
Protection circuit	diode
Connection terminals	2.5 mm <sup>2</sup> fixed screw type

Output voltage	<b>0...35 Vdc</b>
Continuous load current	<b>5 A</b> @ 60°C
Max. current	120 A (peak)
Leakage current 0 signal	10 μA
OFF/ON switching time	100 μs / 1 ms
Protection circuit	diode
Connection terminals	2.5 mm <sup>2</sup> fixed screw type

## GENERAL TECHNICAL DATA

Operating temperature	-20...+80°C over 40°C apply a derating of 0.04A/°C
I/O isolation (coil/contact)	2.5 kVac / 60 s
Protection degree	IP 00 IEC529, EN60529
Reference Standard	IEC 664-1, DIN VDE 0110.1
Pollution degree	3
Overtoltage category	III
Modello del relé (1)	HF JGX-40F
Status display	LED
Housing material	Polyamide UL94V-0
Approx. weight	—
Mounting information	vertical on rail adjacent without gap

Operating temperature	-20...+80°C over 60°C apply a derating of 0,05A/°C
I/O isolation (coil/contact)	2.5 kVac / 60 s
Protection degree	IP 00 IEC529, EN60529
Reference Standard	IEC 664-1, DIN VDE 0110.1
Pollution degree	3
Overtoltage category	III
Modello del relé (1)	ELCO SSR91-60B
Status display	LED
Housing material	Polyamide UL94V-0
Approx. weight	—
Mounting information	vertical on rail adjacent without gap

## MOUNTING ACCESSORIES

Mounting rail type according to IEC60715/TH35	<b>PR/3/AC, PR/3/AS</b>
Mounting rail type according to IEC60715/G32	—
Replacement relay (1)	Cat. No. 8904404
Screw type jumper	Cat. No. XCMB16B
black	—
white	—
blue	—

Mounting rail type according to IEC60715/TH35	<b>PR/3/AC, PR/3/AS</b>
Mounting rail type according to IEC60715/G32	—
Replacement relay (1)	Cat. No. 8904402
Screw type jumper	Cat. No. XCMB16B
black	—
white	—
blue	—



Screw type jumper

# Solid state 12-24 Vdc single relay

- Low cost
- For AC load (T version)
- Pluggable relay
- Screw type jumper available
- Status LED display

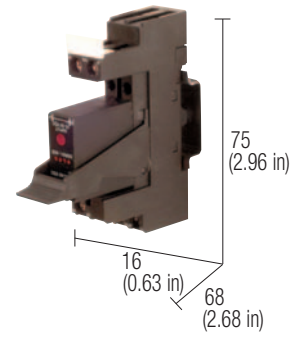
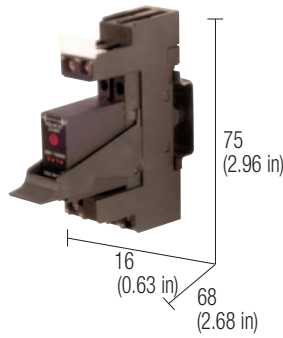

## NOTES

(1) Relay model is not binding, they may be modified without prior warning. The technical data shown here is to be considered typical.  
 (2) Version available upon request; for information call our sales department, local agent or representative

This series can be mounted without any spacing between adjacent components.

## BLOCK DIAGRAM

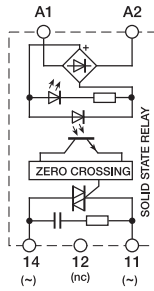

## BLOCK DIAGRAM

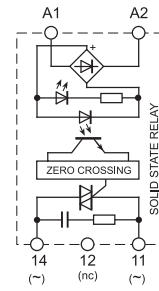

## VERSIONS

Pluggable relay  
 Fixed relay

Cat. No. XCM1T024

CM1T024 (2)

Cat. No. XCM1T024E

CM1T024E (2)

## INPUT TECHNICAL DATA

Input voltage	<b>24 Vdc</b> (19.2... 28.8 Vdc)
Level 1 (high) input signal	> 19.2 Vdc
Level 0 (low) input signal	< 1 Vdc
Rated current (1 channel)	< 20 mA
Switching frequency	100 Hz max
Connection terminals	2.5 mm <sup>2</sup> fixed screw type

Input voltage	<b>12-24 Vdc</b> (10... 32 Vdc)
Level 1 (high) input signal	> 10 Vdc
Level 0 (low) input signal	< 9 Vdc
Rated current (1 channel)	< 13 mA
Switching frequency	100 Hz max
Connection terminals	2.5 mm <sup>2</sup> fixed screw type

## OUTPUT TECHNICAL DATA

Output voltage	<b>48...280 Vac</b> (zero crossing)
Continuous load current	<b>3 A</b> @ 40°C
Max. current	120 A / 10 ms
Leakage current 0 signal	5 mA
OFF/ON switching time	1/2 cycle + 1 ms
Protection circuit	—
Connection terminals	2.5 mm <sup>2</sup> fixed screw type

Output voltage	<b>12...275 Vac</b> (zero crossing)
Continuous load current	<b>3,5A</b> @ 40°C / <b>3 A</b> @ 60°C
Max. current	120 A (peak)
Leakage current 0 signal	1 mA
OFF/ON switching time	10 ms / 10 ms max.
Protection circuit	—
Connection terminals	2.5 mm <sup>2</sup> fixed screw type

## GENERAL TECHNICAL DATA

Operating temperature	-20...+80°C over 40°C apply a derating of 0.05A/°C
I/O isolation (coil/contact)	2.5 kVac / 60 s
Protection degree	IP 00 IEC529, EN60529
Reference Standard	IEC 664-1, DIN VDE 0110.1
Pollution degree	3
Overvoltage category	III
Modello del relé (1)	HF JGX-40F
Status display	LED
Housing material	Polyamide UL94V-0
Approx. weight	—
Mounting information	vertical on rail adjacent without gap

Operating temperature	-20...+80°C over 40°C apply a derating of 0,025A/°C
I/O isolation (coil/contact)	2.5 kVac / 60 s
Protection degree	IP 00 IEC529, EN60529
Reference Standard	IEC 664-1, DIN VDE 0110.1
Pollution degree	3
Overvoltage category	III
Modello del relé (1)	ELCO SSR91-60B
Status display	LED
Housing material	Polyamide UL94V-0
Approx. weight	—
Mounting information	vertical on rail adjacent without gap

## MOUNTING ACCESSORIES

Mounting rail type according to IEC60715/TH35	<b>PR/3/AC, PR/3/AS</b>
Mounting rail type according to IEC60715/G32	—
Replacement relay (1)	Cat. No. 8904405
Screw type jumper	Cat. No. XCMB16B
—	—
—	—

Mounting rail type according to IEC60715/TH35	<b>PR/3/AC, PR/3/AS</b>
Mounting rail type according to IEC60715/G32	—
Replacement relay (1)	Cat. No. 8904403
Screw type jumper	Cat. No. XCMB16B
—	—
—	—



Screw type jumper

# Solid state 12-24 Vdc single relay with fuse

- 5 A / 24 Vdc rated current
- Common negative or positive input
- Overload, short-circuit protected output with replaceable fuse
- Status LED display, reverse polarity protection
- 6 mm wide
- Plug-in jumper available

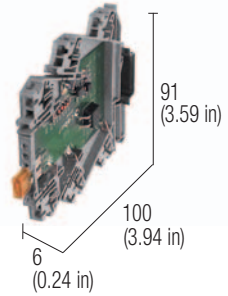
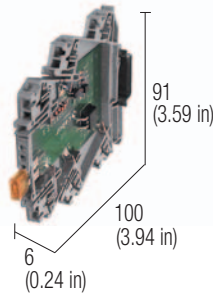

## NOTES

- (1) The fast blow-out fuse is calibrated to protect the output stage of the module and it is connected in series to the positive pole; it is possible to replace the fuse with lower rated current values, selected to protect also the load and its wires; a fuse having a current rating higher than 5 A does not protect the output against short circuit and overloads.
- (2) In order to assure the IP20 protection degree, the last module must be protected and insulated using the CK/PT end section.
- (3) Version available upon request; for information call our sales department, local agent or representative

## BLOCK DIAGRAM

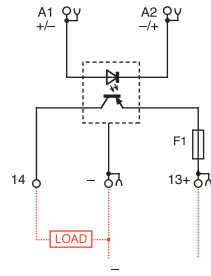

## BLOCK DIAGRAM

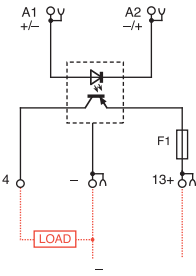

## VERSIONS

- Pluggable relay
- Fixed relay

Cat. No. XCKS15NA

CKS15NA (3)

Cat. No. XCKS15NB

CKS15NB

## INPUT TECHNICAL DATA

Input voltage	4.5...12 Vdc
Level 1 (high) input signal	≥4.5 Vdc
Level 0 (low) input signal	≤4 Vdc
Rated current	≤5 mA @ 12 Vdc

Input voltage	19...30 Vdc
Level 1 (high) input signal	≥ 20 Vdc
Level 0 (low) input signal	≤18 Vdc
Rated current	≤ 5 mA @ 24 Vdc

## OUTPUT TECHNICAL DATA

Output voltage	5.2...60 Vdc, max. 100 V (peak)
Continuous load current	5 A / 24 Vdc @ 25°C
Max. current	7.5 A / 1 s, 25 A / 50 ms
Min. applicable load	5.2 V / 10 mA
Leakage current 0 signal	25 µA @ 60 Vdc between 13 and 14
Isolation between open contacts	3 kVac / 60 s
Protection fuse (1)	F 5 A

Output voltage	5.2...60 Vdc, max. 100 V (peak)
Continuous load current	5 A / 24 Vdc @ 25°C
Max. current	7.5 A / 1 s, 25 A / 50 ms
Min. applicable load	5.2 V / 10 mA
Leakage current 0 signal	25 µA @ 60 Vdc between 13 and 14
Isolation between open contacts	3 kVac / 60 s
Protection fuse (1)	F 5 A

## GENERAL TECHNICAL DATA

Operating temperature	-20...+60°C
I/O isolation	3 kVac / 60 s
Max. switching frequency	400 Hz max.
Protection degree	IP20 IEC529 EN60529
Reference Standard	IEC 664-1, EN50081-1
Pollution degree	2
Overvoltage category	II
Connection terminals	2.5 mm <sup>2</sup> (AWG 14), AWG26-14 spring type
Housing material	Polyamide UL94V-0
Approx. weight	32 g (1.13 oz)
Mounting information	vertical on rail adjacent without gap

Operating temperature	-20...+60°C
I/O isolation	3 kVac / 60 s
Max. switching frequency	400 Hz max.
Protection degree	IP20 IEC529 EN60529
Reference Standard	IEC 664-1, EN50081-1
Pollution degree	2
Overvoltage category	II
Connection terminals	2.5 mm <sup>2</sup> (AWG 14), AWG26-14 spring type
Housing material	Polyamide UL94V-0
Approx. weight	32 g (1.13 oz)
Mounting information	vertical on rail adjacent without gap

## MOUNTING ACCESSORIES

Mounting rail type according to IEC60715/TH35-7,5	PR/3/AC, PR/3/AC/ZB, PR/3/AS, PR/3/AS/ZB
Mounting rail type according to IEC60715/G32	—
Replacement relay (1)	—
Plug-in jumper	Cat. No. PTCK42 (42 poles)
Marking tags	blank Cat. No. NU0851

Mounting rail type according to IEC60715/TH35-7,5	PR/3/AC, PR/3/AC/ZB, PR/3/AS, PR/3/AS/ZB
Mounting rail type according to IEC60715/G32	—
Replacement relay (1)	—
Plug-in jumper	Cat. No. PTCK42 (42 poles)
Marking tags	blank Cat. No. NU0851

End plate Cat. No. XCKPT

End plate Cat. No. XCKPT



# Solid state 12-24 Vdc single relay with electronic

- Electronic protection from short circuit, overload, overtemperature
- Input and output status LED
- Output extravoltage suppressor diode
- Extralow current absorbing
- Plug-in jumper available

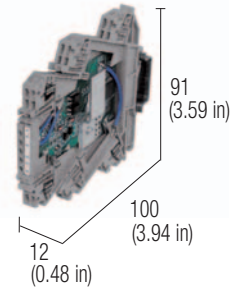
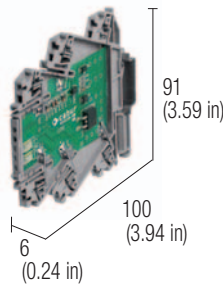

## NOTES

- (1) Maximum output current of each channel depends on surrounding air temperature, on the number of output contemporarily active and on the current flowing through them; the given value is measured with 4 active outputs and 4 not active
- (2) All outputs are overcurrent and overtemperature; when ovd or ovt protections cuts off the output current, the output display led turns off or reduces its light depending on ovd degree; the output turns on automatically when the ovd or ovt are removed.
- (3) Version available upon request; for information call our sales department, local agent or representative

## VERSIONS

- Pluggable relay
- Fixed relay

## BLOCK DIAGRAM

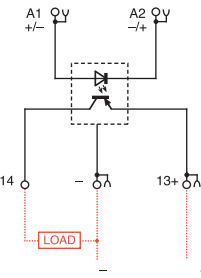

## BLOCK DIAGRAM

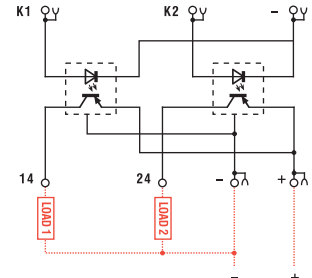

Cat. No. XCKS15E

CKS15E

Cat. No. XCKS22

CKS22 (3)

## INPUT TECHNICAL DATA

Input voltage	5...24 Vdc (4.2...32 Vdc)
Level 1 (high) input signal	> 3.5 Vdc
Level 0 (low) input signal	< 3.5 Vdc
Rated current	≤ 5 mA @ 24 Vdc
Input channels	1

Input voltage	5...24 Vdc (4.2...32 Vdc)
Level 1 (high) input signal	> 3.5 Vdc
Level 0 (low) input signal	< 3.5 Vdc
Rated current	≤ 5 mA @ 24 Vdc
Input channels	1

Input voltage	12...24 Vdc (range 8...33 Vdc)
Level 1 (high) input signal	≥ 12 Vdc
Level 0 (low) input signal	≤ 11.7 Vdc
Rated current	≤ 5 mA @ 24 Vdc
Input channels	2 with common negative

## OUTPUT TECHNICAL DATA

Output voltage	5...24 Vdc (5...32 Vdc)
Continuous load current	5 A / 24 Vdc @ 45°C (1)
Max. current	7.5 A / 60 s, 2.5 A / 50 ms peak (1)
Min. applicable load	5.2 V / 100 mA
Max. switching frequency	200 Hz max.
Leakage current 0 signal	< 25 μA @ 24 Vdc
Isolation between open contacts	—
Protection	electronic from overload, overtemperature (2)

Output voltage	5...24 Vdc (5...32 Vdc)
Continuous load current	5 A / 24 Vdc @ 45°C (1)
Max. current	7.5 A / 60 s, 2.5 A / 50 ms peak (1)
Min. applicable load	5.2 V / 100 mA
Max. switching frequency	200 Hz max.
Leakage current 0 signal	< 25 μA @ 24 Vdc
Isolation between open contacts	—
Protection	electronic from overload, overtemperature (2)

Output voltage	12...24 Vdc (range 5...33 Vdc)
Continuous load current	2 x 2.5 A / 24 Vdc @ 45°C
Max. current	4.4 A
Min. applicable load	10 mA
Max. switching frequency	—
Leakage current 0 signal	1 mA @ 24 Vdc
Isolation between open contacts	3 kVac / 60 s
Protection	—

## GENERAL TECHNICAL DATA

Operating temperature	-20 ... +60°C (with therml protection) (2)
I/O isolation	3 kVac / 60 s
Max. switching frequency	—
Protection degree	IP20 IEC529 EN60529
Reference Standard	IEC 664-1, EN50081-1
Pollution degree	2
Overvoltage category	II
Connection terminals	2.5 mm <sup>2</sup> AWG26-14 fixed spring type
Housing material	Polyamide UL94V-0
Approx. weight	30 g (1.06 oz)
Mounting information	vertical on rail adjacent without gap

Operating temperature	-20 ... +60°C (with therml protection) (2)
I/O isolation	3 kVac / 60 s
Max. switching frequency	—
Protection degree	IP20 IEC529 EN60529
Reference Standard	IEC 664-1, EN50081-1
Pollution degree	2
Overvoltage category	II
Connection terminals	2.5 mm <sup>2</sup> AWG26-14 fixed spring type
Housing material	Polyamide UL94V-0
Approx. weight	30 g (1.06 oz)
Mounting information	vertical on rail adjacent without gap

Operating temperature	-20 ... +60°C (with therml protection) (2)
I/O isolation	3 kVac / 60 s
Max. switching frequency	1 kHz (Ton <500 ms / Toff <500 ms)
Protection degree	IP20 IEC529 EN60529
Reference Standard	IEC 664-1, EN50081-1
Pollution degree	2
Overvoltage category	II
Connection terminals	2.5 mm <sup>2</sup> AWG26-14 fixed spring type
Housing material	Polyamide UL94V-0
Approx. weight	32 g (1.13 oz)
Mounting information	vertical on rail adjacent without gap

## MOUNTING ACCESSORIES

Mounting rail type according to IEC60715/TH35-7.5	PR/3/AC, PR/3/AC/ZB, PR/3/AS, PR/3/AS/ZB
Mounting rail type according to IEC60715/G32	—
Replacement relay (1)	—
Plug-in jumper	Cat. No. PTCK42 (42 poles)
Marking tags	blank Cat. No. NU0851

Mounting rail type according to IEC60715/TH35-7.5	PR/3/AC, PR/3/AC/ZB, PR/3/AS, PR/3/AS/ZB
Mounting rail type according to IEC60715/G32	—
Replacement relay (1)	—
Plug-in jumper	Cat. No. PTCK42 (42 poles)
Marking tags	blank Cat. No. NU0851

Mounting rail type according to IEC60715/TH35-7.5	PR/3/AC, PR/3/AC/ZB, PR/3/AS, PR/3/AS/ZB
Mounting rail type according to IEC60715/G32	—
Replacement relay (1)	—
Plug-in jumper	Cat. No. PTCK42 (42 poles)
Marking tags	blank Cat. No. NU0851

End plate

Cat. No. XCKPT

Cat. No. XCKPT

# Solid state 12-24 Vdc single relay with electronic SPDT

- 10...40 Vdc rated voltage
- Output with SPDT simulation
- Output voltage 5...48 Vdc 500 mA
- Max switching frequency 1 KHz
- I/O isolation 3.75 kV

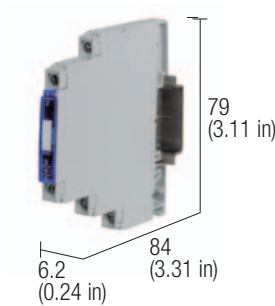

## NOTES

Compared with standard relays, solid state relays offers many advantages: much longer life, higher switching frequency, lower EMI emissions, higher vibrations withstand capability, wider input voltage range and 70% lower input current. The output of solid state relays is a N.O. type "contact" and up to now SPDT type was not available, forcing to use a standard relay when SPDT function was required. Thanks to a new technology, this new solid state relay offers all the advantages of solid state relays with a SPDT contact output type, making a step ahead possible.

## BLOCK DIAGRAM

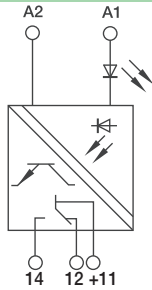

## VERSIONS

- Pluggable relay
- Fixed relay

Cat. No. X766083

CWOT 6-2083

## INPUT TECHNICAL DATA

Input signal	24 Vdc (range 10...40 Vdc)
Level 1 (high) input signal (ON)	>5 Vdc
Level 0 (low) input signal (OFF)	<5 Vdc
Rated current	6 mA
Protection device	suppressor diode

## OUTPUT TECHNICAL DATA

Output signal	5...48 Vdc
Continuous load current	10...500 mA
Switching delay	12 μs ON / 12 μs OFF
Protection device	suppressor diode
Output Type	NPN / PNP transistor, with changeover contact simulation

## GENERAL TECHNICAL DATA

Operating temperature	-25 ...+60°C
I/O isolation	3.75 kVac / 60 s
Max. switching frequency	<1 KHz
Protection degree	IP 20 IEC529 EN60529
Reference Standard	IEC 664-1, DIN VDE
Pollution degree	2
Overvoltage category	III
Connection terminals	2.5 mm <sup>2</sup> fixed screw type
Housing material	PPE
Approx. weight	29 g (1.02 oz)
Mounting information	vertical on rail adjacent without gap

## MOUNTING ACCESSORIES

Mounting rail type according to IEC60715/TH35	<b>PR/3/AC, PR/3/AC/ZB, PR/3/AS, PR/3/AS/ZB</b>
Mounting rail type according to IEC60715/G32	—
Replacement relay (1)	—
Plug-in jumper	—
Marking tags	blank
	printed
	printed
End plate	—

# Signal optoisolators

- Suitable for isolation and transmission of digital signal with high frequency
- Status LED display
- 5, 12 and 24 rated voltage
- I/O isolation

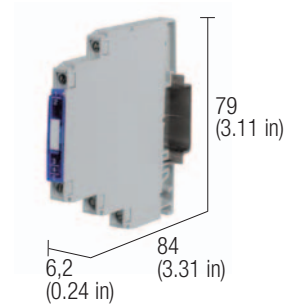
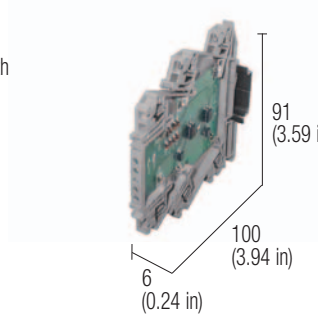

## NOTES

(1) Version available upon request.  
 CKS1S can isolate I/O high frequency signal circuits (encoders, counters etc.) to eliminate influence of different ground reference voltages and ground loops, thus reducing EMI noise influence on signal transmission of sensitive signals; it is always recommended to use balanced type shielded cables (two signal wires + shield); at transmission frequencies higher than 25 Hz the LED light appears constant, it is to be intended as "transmission ON" signal.

## BLOCK DIAGRAM

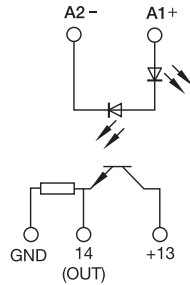

## BLOCK DIAGRAM

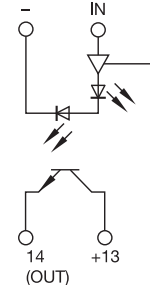

## VERSIONS

Cat. No. XCKS1S  
 CKS1S (1)

Cat. No. X766082  
 CWOT 6-2082

## INPUT TECHNICAL DATA

Input signal	3...30 Vdc
Level 1 (high) input signal (ON)	≥ 3 Vdc
Level 0 (low) input signal (OFF)	≤ 3 Vdc
Rated current	≤ 10 mA @ 24 Vdc

Input signal	3...30 Vdc
Level 1 (high) input signal (ON)	≥ 3 Vdc
Level 0 (low) input signal (OFF)	≤ 3 Vdc
Rated current	≤ 10 mA @ 24 Vdc

Input signal	4.5...28 Vdc
Level 1 (high) input signal (ON)	>4.2 Vdc
Level 0 (low) input signal (OFF)	<2.7 Vdc
Rated current	0.1 mA

## OUTPUT TECHNICAL DATA

Output signal	3...30 Vdc
Continuous load current	80 mA / 30 Vdc @ 25°C
Min. applicable load	10 mV / 2 mA
Switching delay	—

Output signal	3...30 Vdc
Continuous load current	80 mA / 30 Vdc @ 25°C
Min. applicable load	10 mV / 2 mA
Switching delay	—

Output signal	5...48 Vdc
Continuous load current	10...500 mA
Min. applicable load	—
Switching delay	12 μs ON / 12 μs OFF

## GENERAL TECHNICAL DATA

Operating temperature	-20...+60°C
I/O isolation	3 kVac / 60 s
Max. switching frequency	20 kHz max. duty cycle 50/50, 70/30 max
Protection degree	IP 20 IEC529 EN60529
Reference Standard	IEC 664-1, EN50081-1
Pollution degree	2
Overvoltage category	II
Connection terminals	2.5 mm <sup>2</sup> (AWG 14), AWG26-14 spring type
Housing material	Polyamide UL94V-0
Approx. weight	32 g (1.13 oz)
Mounting information	vertical on rail adjacent without gap

Operating temperature	-20...+60°C
I/O isolation	3 kVac / 60 s
Max. switching frequency	20 kHz max. duty cycle 50/50, 70/30 max
Protection degree	IP 20 IEC529 EN60529
Reference Standard	IEC 664-1, EN50081-1
Pollution degree	2
Overvoltage category	II
Connection terminals	2.5 mm <sup>2</sup> (AWG 14), AWG26-14 spring type
Housing material	Polyamide UL94V-0
Approx. weight	32 g (1.13 oz)
Mounting information	vertical on rail adjacent without gap

Operating temperature	-25...+60°C
I/O isolation	3.75 kVac / 60 s
Max. switching frequency	<20 KHz
Protection degree	IP 20 IEC529 EN60529
Reference Standard	IEC 664-1, DIN VDE
Pollution degree	2
Overvoltage category	III
Connection terminals	2.5 mm <sup>2</sup> , AWG26-14 a vite
Housing material	PPE
Approx. weight	29 g (1.02 oz)
Mounting information	vertical on rail adjacent without gap

## MOUNTING ACCESSORIES

Mounting rail type according to IEC60715/TH35	—
Mounting rail type according to IEC60715/G32	—
Replacement relay (1)	—
Plug-in jumper	—
Marking tags	blank printed printed
End plate	—

Mounting rail type according to IEC60715/TH35	PR/3/AC, PR/3/AC/ZB, PR/3/AS, PR/3/AS/ZB
Mounting rail type according to IEC60715/G32	—
Replacement relay (1)	—
Plug-in jumper	Cat. No. PTCK42 (42 poles)
Marking tags	Cat. No. NU0851
Marking tags	—
Marking tags	—
End plate	Cat. No. XCKPT

Mounting rail type according to IEC60715/TH35	PR/3/AC, PR/3/AC/ZB, PR/3/AS, PR/3/AS/ZB
Mounting rail type according to IEC60715/G32	—
Replacement relay (1)	—
Plug-in jumper	—
Marking tags	—
Marking tags	—
Marking tags	—
End plate	—

# Solid state 24 Vdc relay modules

- For DC load
- Pluggable relay
- Status LED display

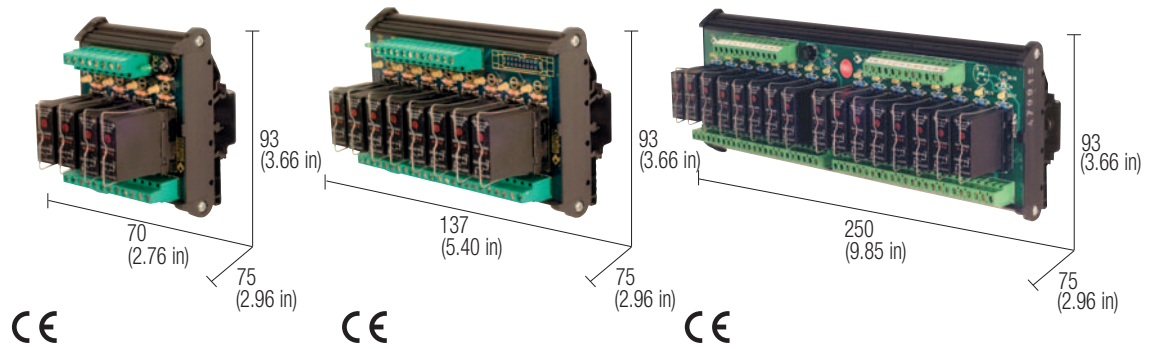

## NOTES

(1) Relay model is not binding, they may be modified without prior warning. The technical data shown here is to be considered typical.  
 (2) Version available upon request; for information call our sales department, local agent or representative

### POWER SUPPLY

A1 = +	A2 = -	negative common
A1 = -	A2 = +	positive common

## BLOCK DIAGRAM

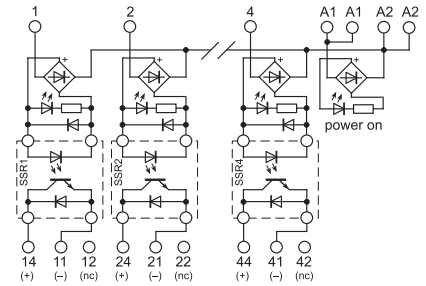

4 relay module

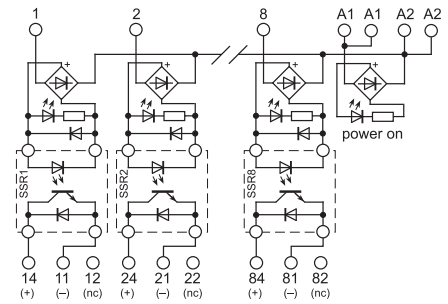

8 relay module

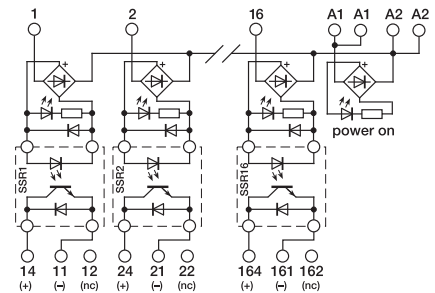

16 relay module

## VERSIONS

4 relay module

8 relay module

16 relay module

Cat. No. XR042S24

Cat. No. XR082S24

Cat. No. XR162S24

R42S24 (2)

R82S24 (2)

R162S24 (2)

## INPUT TECHNICAL DATA

Input voltage	<b>24 Vdc</b> (19.2...28.8 Vdc)
Level 1 (high) input signal	> 19.2 Vdc
Level 0 (low) input signal	< 1 Vdc
Rated current (1 channel)	< 20 mA
Switching frequency	100 Hz max

## OUTPUT TECHNICAL DATA

Output voltage	<b>3...50 Vdc</b>
Continuous load current	<b>2 A @ 40°C</b>
Max. current	8 A / 10 ms
Leakage current 0 signal	0.1 mA
OFF/ON switching time	100 µs / 1 ms
Protection circuit	diode
Current of the fuse max.	—

## GENERAL TECHNICAL DATA

Operating temperature range	-20...+80°C over 40°C apply a derating of 0.04A/°C		
I/O isolation	2.5 kVac / 60 s		
Isolation between output terminals	1 kVac / 60 s (between open contact)		
Protection degree	IP 00 IEC 529, EN60529		
Overtoltage category / Pollution degree	III / 2		
Reference Standard	IEC 664-1, DIN VDE 0110.1		
Status display	green LED / yellow LED		
Connection terminal	2.5 mm <sup>2</sup> fixed screw type		
Housing material	UL94V-0 plastic material		
Approx. weight	207 g (7.31 oz)	379 g (13.38 oz)	756 g (26.69 oz)
Mounting information	vertical on rail adjacent without gap		

## MOUNTING ACCESSORIES

Mounting rail type according to IEC60715/TH35	PR/3/AC, PR/3/AC/ZB, PR/3/AS, PR/3/AS/ZB
Mounting rail type according to IEC60715/G32	PR/DIN/AC - PR/DIN/AS - PR/DIN/AL
Replacement relay (1)	Cat. No. 8904404
Screw type jumper	—

# Solid state 24 Vdc relay modules

- For AC load
- Pluggable relay
- Status LED display

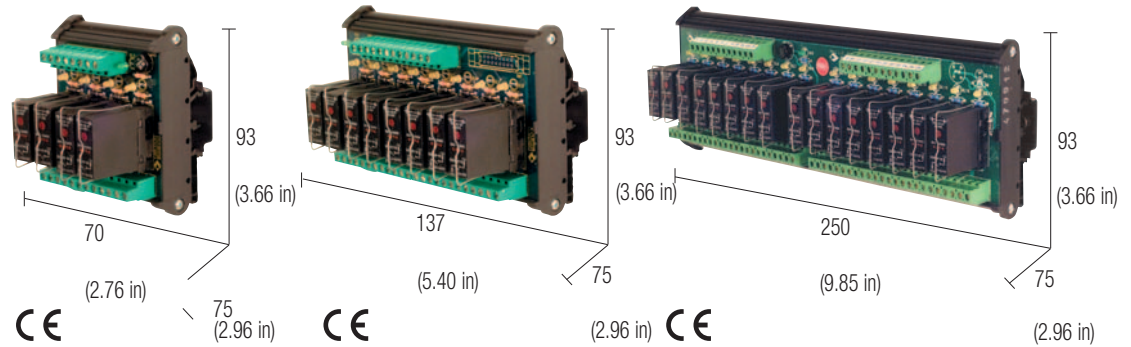

## NOTES

- (1) Relay model is not binding, they may be modified without prior warning. The technical data shown here is to be considered typical.
- (2) Version available upon request; for information call our sales department, local agent or representative

### POWER SUPPLY

A1 = +	A2 = -	negative common
A1 = -	A2 = +	positive common

## BLOCK DIAGRAM

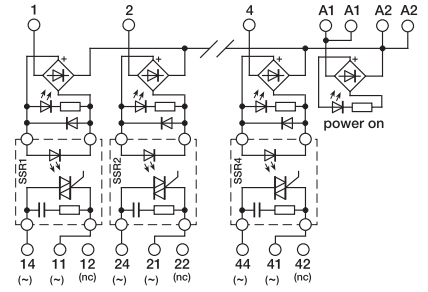

4 relay module

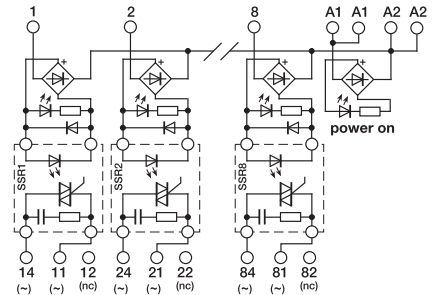

8 relay module

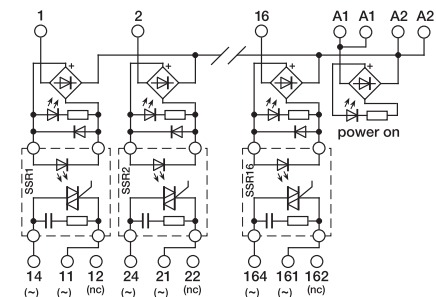

16 relay module

## VERSIONS

4 relay module

8 relay module

16 relay module

Cat. No. XR042T24

Cat. No. XR082T24

Cat. No. XR162T24

R42T24 (2)

R82T24 (2)

R162T24 (2)

## INPUT TECHNICAL DATA

Input voltage	24 Vdc (19.2...28.8 Vdc)
Level 1 (high) input signal	> 19.2 Vdc
Level 0 (low) input signal	< 1 Vdc
Rated current (1 channel)	< 20 mA
Switching frequency	100 Hz max

## OUTPUT TECHNICAL DATA

Output voltage	48...240 Vac (passage à zéro)
Continuous load current	3 A @ 40°C
Max. current	120 A / 10 ms
Leakage current 0 signal	5 mA
OFF/ON switching time	1/2 cycle + 1 ms
Protection circuit	—
Current of the fuse max.	—

## GENERAL TECHNICAL DATA

Operating temperature range	-20...+80°C over 40°C apply a derating of 0.05A/°C
I/O isolation	2.5 kVac / 60 s
Protection degree	1 kVac / 60 s (between open contact)
Reference Standard	IP 00 IEC 529, EN60529
Pollution degree	III / 2
Overtoltage category	IEC 664-1, DIN VDE 0110.1
Modello del relé (1)	green LED / yellow LED
Status display	2.5 mm <sup>2</sup> fixed screw type
Housing material	UL94V-0 plastic material
Approx. weight (4/8/16 relé)	207 g (7.31 oz)   379 g (13.38 oz)   756 g (26.69 oz)
Mounting information	vertical on rail adjacent without gap

## MOUNTING ACCESSORIES

Mounting rail type according to IEC60715/TH35	PR/3/AC, PR/3/AC/ZB, PR/3/AS, PR/3/AS/ZB
Mounting rail type according to IEC60715/G32	PR/DIN/AC - PR/DIN/AS - PR/DIN/AL
Replacement relay (1)	Cat. No. 8904405
Screw type jumper	—

# Solid state 24 Vdc relay modules with fuse

- For DC load
- Protection fuse on output
- Pluggable relay
- Status LED display

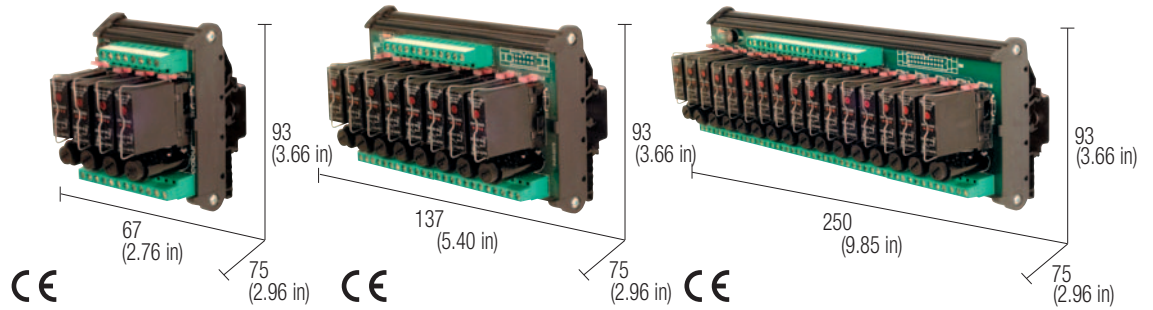

## NOTES

- (1) Relay model is not binding, they may be modified without prior warning. The technical data shown here is to be considered typical.
- (2) The fuse must be dimensioned according to load. The max. value of 6.3 A is referred to EN60127-complying fuses and the homologation rated current of the fuse-holder. Fuses of a higher value may damage the fuse-holder and module.
- (3) Version available upon request; for information call our sales department, local agent or representative

### POWER SUPPLY

A1 = +	A2 = -	negative common
A1 = -	A2 = +	positive common

## BLOCK DIAGRAM

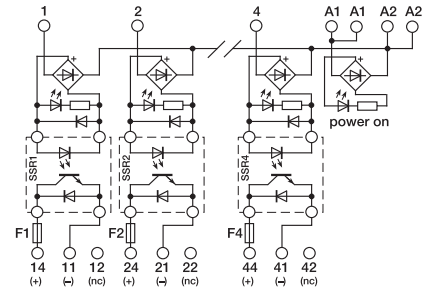

4 relay module

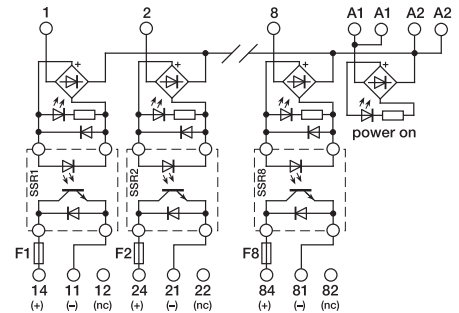

8 relay module

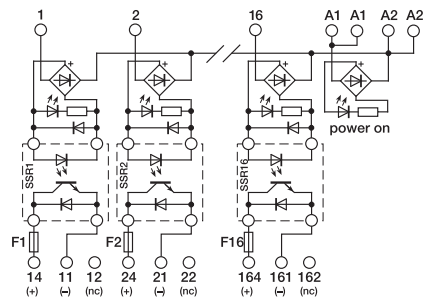

16 relay module

## VERSIONS

4 relay module

8 relay module

16 relay module

Cat. No. XR041S24F	Cat. No. XR081S24F	Cat. No. XR161S24F
R41S24F (3)	R81S24F (3)	R161S24F (3)

## INPUT TECHNICAL DATA

Input voltage	24 Vdc (19.2...28.8 Vdc)
Level 1 (high) input signal	> 19.2 Vdc
Level 0 (low) input signal	< 1 Vdc
Rated current (1 channel)	< 20 mA
Switching frequency	100 Hz max

## OUTPUT TECHNICAL DATA

Output voltage	3...50 Vdc
Continuous load current	2 A @ 40°C
Max. current	8 A / 10 ms
Leakage current 0 signal	0.1 mA
OFF/ON switching time	100 µs / 1 ms
Protection circuit	diode
Current of the fuse max.	—

## GENERAL TECHNICAL DATA

Operating temperature range	-20...+80°C over 40°C apply a derating of 0.04A/°C
I/O isolation	2.5 kVac / 60 s
Isolation between output terminals	1 kVac / 60 s (between open contact)
Protection degree	IP 00 IEC 529, EN60529
Overvoltage category / Pollution degree	III / 2
Reference Standard	IEC 664-1, DIN VDE 0110.1
Status display	green LED / yellow LED
Connection terminal	2.5 mm <sup>2</sup> fixed screw type
Housing material	UL94V-0 plastic material
Approx. weight	207 g (7.31 oz)   379 g (13.38 oz)   756 g (26.69 oz)
Mounting information	vertical on rail adjacent without gap

## MOUNTING ACCESSORIES

Mounting rail type according to IEC60715/TH35	PR/3/AC, PR/3/AC/ZB, PR/3/AS, PR/3/AS/ZB
Mounting rail type according to IEC60715/G32	PR/DIN/AC - PR/DIN/AS - PR/DIN/AL
Replacement relay (1)	Cat. No. 8904404
Screw type jumper	—



# Solid state 24 Vdc relay modules with electronic protection

- Rated current output 8 x 2.5 A / 5 - 33 Vdc
- Short circuit, overload, over temperature, overvoltage output protection
- 12-24 Vdc negative common input, 8 status LED K1 and K8
- 8 output status LED, input/output anti polarity inversion diodes
- 70 mm wide

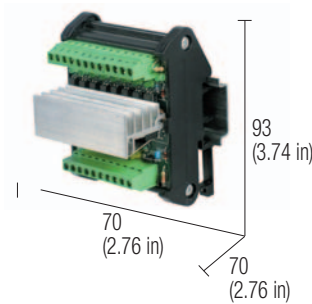

## NOTES

- (1) Maximum output current of each channel depends on surrounding air temperature, on the number of output contemporarily active and on the current flowing through them; the given value is measured with 4 active outputs and 4 not active.
- (2) All outputs are overcurrent and overtemperature; when ovd or ovt protections cuts off the output current, the output display led turns off or reduce its light depending on ovd degree; the output turns on automatically when the ovd or ovt are removed.
- (3) Version available upon request

## BLOCK DIAGRAM

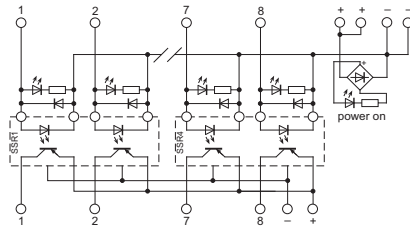

## VERSIONS

4 relay module

8 relay module

16 relay module

## INPUT TECHNICAL DATA

Input voltage	<b>5-24 Vdc</b> (range 4.2...32 Vdc) negative common
Level 1 (high) input signal	> 3.5 Vdc
Level 0 (low) input signal	< 3.5 Vdc
Rated current (1 channel)	5 mA ±10%
Switching frequency	500 Hz

## OUTPUT TECHNICAL DATA

Output voltage	12-24 Vdc, (range 5...32 Vdc) negative common
Continuous load current	8 x 2.5 A @ 25°C (1)
Max. current	4.4 A
Leakage current 0 signal	25 µA max @ 24Vdc
OFF/ON switching time	200 Hz (Ton < 500 µs / Toff < 500 µs)
Protection circuit	electronic against short circuit / overload / overtemperature (2)
Min. applicable load	5.2 Vdc/ 100 mA

## GENERAL TECHNICAL DATA

Operating temperature range	-20...-60°C (with therml protection) (2)
I/O isolation	2.5 kVac / 60 s
Isolation between output terminals	1 kVac / 60 s (between open contact)
Protection degree	IP 00 IEC 529, EN60529
Overvoltage category / Pollution degree	III / 2
Reference Standard	IEC 664-1, DIN VDE 0110.1
Status display	green LED (DC OK) / yellow LED (output OK)
Connection terminal	2.5 mm <sup>2</sup> fixed screw type
Housing material	UL94V-0 plastic material
Approx. weight	
Mounting information	vertical on rail adjacent without gap

## MOUNTING ACCESSORIES

Mounting rail type according to IEC60715/TH35	PR/3/AC, PR/3/AC/ZB, PR/3/AS, PR/3/AS/ZB
Mounting rail type according to IEC60715/G32	PR/DIN/AC - PR/DIN/AS - PR/DIN/AL
Replacement relay (1)	—
Screw type jumper	—

# Passive interface modules selection table

These tables allow you to quickly select only the items, then check if all product's technical data meet your application requirements.

## Sub-D / Terminal modules

Version	Dimensions AxBxC	Tipology	Type	Cat. No.	Page
9 poles	37x66x93	(6)	ISD09FM	XISD09FM	142
	37x66x93	(5)	ISD09PF	XISD09PF	142
	37x66x93	(8)	ISD09PM	XISD09PM	142
15 poles	47x66x93	(6)	ISD15FM	XISD15FM	142
	47x66x93	(5)	ISD15PF	XISD15PF	142
	47x66x93	(8)	ISD15PM	XISD15PM	142
25 poles	70x66x93	(6)	ISD25FM	XISD25FM	142
	70x66x93	(5)	ISD25PF	XISD25PF	142
	70x66x93	(8)	ISD25PM	XISD25PM	142
	57x80x93	(5) (11)	CPD25F	XCPD25F	144
	57x80x93	(8) (11)	CPD25M	XCPD25M	144
37 poles	107x66x93	(6)	ISD37FM	XISD37FM	142
	107x66x93	(5)	ISD37PF	XISD37PF	142
	107x66x93	(8)	ISD37PM	XISD37PM	142
	77x80x93	(5) (11)	CPD37F	XCPD37F	144
	77x80x93	(8) (11)	CPD37M	XCPD37M	144
50 poles	92x80x93	(5) (11)	CPD50F	XCPD50F	144
	92x80x93	(8) (11)	CPD50M	XCPD50M	144

## Diode-holder modules

Version	Dimensions AxBxC	Tipology	Type	Cat. No.	Page
8 diodes	25x60x76	(4)	CDM08CS	XCDM08CS	159
	45x65x93	(1)	CDM08AC	XCDM08AC	160
	45x65x93	(2)	CDM08CC	XCDM08CC	160
16 diodes	50x65x93	(4)	CDM16CS	XCDM16CS	159
	92x65x93	(1)	CDM16AC	XCDM16AC	160
	92x65x93	(2)	CDM16CC	XCDM16CC	160
24 diodes	71x65x93	(4)	CDM24CS	XCDM24CS	159
	137x65x93	(1)	CDM24AC	XCDM24AC	160
	137x65x93	(2)	CDM24CC	XCDM24CC	160
	137x65x93	(2)	CDM24CC	XCDM24CC	160

## Lamp testing modules

Version	Dimensions AxBxC	Tipology	Type	Cat. No.	Page
8 diodes	45x65x93	(1)	CLT08AC	XCLT08AC	150
	45x65x93	(2)	CLT08CC	XCLT08CC	150
	45x65x93		CLP08CC	XCLP08CC	151
16 diodes	92x65x93	(1)	CLT16AC	XCLT16AC	150
	92x65x93	(2)	CLT16CC	XCLT16CC	150
	92x65x93		CLP16CC	XCLP16CC	151

## Flat / Terminal modules

Version	Dimensions AxBxC	Tipology	Type	Cat. No.	Page
10 poles	42x66x93	(8)	IF10PMS	XIF10PMS	145
	42x66x93	(8) (7)	IF10PML	XIF10PML	145
14 poles	48x66x93	(8)	IF14PMS	XIF14PMS	145
	48x66x93	(8) (7)	IF14PML	XIF14PML	145
16 poles	58x66x93	(8)	IF16PMS	XIF16PMS	145
	58x66x93	(8) (7)	IF16PML	XIF16PML	145
20 poles	70x66x93	(8)	IF20PMS	XIF20PMS	145
	70x66x93	(8) (7)	IF20PML	XIF20PML	145
	47x80x93	(8) (11)	CPC20M	XPC20M	146
26 poles	86x66x93	(8)	IF26PMS	XIF26PMS	145
	86x66x93	(8) (7)	IF26PML	XIF26PML	145
	57x80x93	(8) (11)	CPC26M	XCPC26M	146
34 poles	107x66x93	(8)	IF34PMS	XIF34PMS	145
	107x66x93	(8) (7)	IF34PML	XIF34PML	145
	70x80x93	(8) (11)	CPC34M	XCPC34M	146
40 poles	122x66x93	(8)	IF40PMS	XIF40PMS	145
	122x66x93	(8) (7)	IF40PML	XIF40PML	145
	77x80x93	(8) (11)	CPC40M	XCPC40M	146
50 poles	92x80x93	(8) (11)	CPC50M	XCPC50M	146
60 poles	107x80x93	(8) (11)	CPC60M	XCPC60M	146
64 poli	117x80x93	(8) (11)	CPC64M	XCPC64M	146

## Component-holder modules

Version	Dimensions AxBxC	Tipology	Type	Cat. No.	Page
4 components	25x66x93	(9)	CCM04SF	XCCM04SF	147
8 components	25x66x93	(10)	CCM08SV	XCCM08SV	147
8 components	47x66x93	(9)	CCM08SF	XCCM08SF	147
8 components	38x66x93	(3)	CCM08CV	XCCM08CV	147
12 components	70x66x93	(9)	CCM12SV	XCCM12SV	147
16 components	47x66x93	(10)	CCM16SV	XCCM16SV	147
24 components	70x66x93	(10)	CCM24SV	XCCM24SV	147

### Legenda

- (1) common anode
- (2) common cathode
- (3) with common terminal
- (4) single diode
- (5) female connector

- (6) female + male connector
- (7) with LED
- (8) male connector
- (9) single component with Faston terminals
- (10) single component with terminal blocks
- (11) compact dimensions

# Passive interfaces (D-Sub/Terminals modules) ISD series

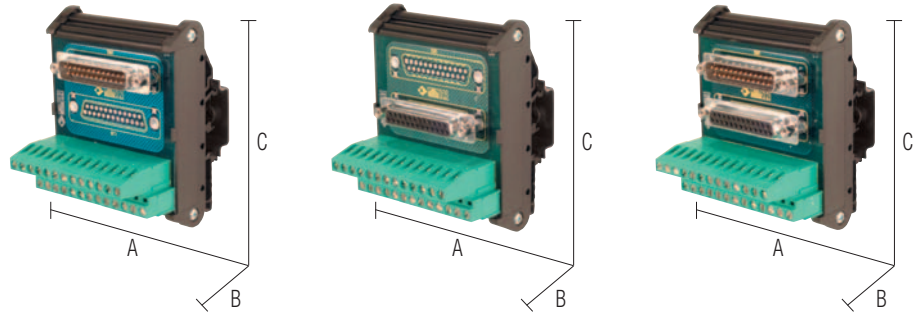

## NOTES

These modules allow the transferring to the terminals of the deriving signals on a cable with D-Sub connector type. The numeration is "pin-to-pin".

(1) Version available upon request; for information call our sales department, local agent or representative

## BLOCK DIAGRAM

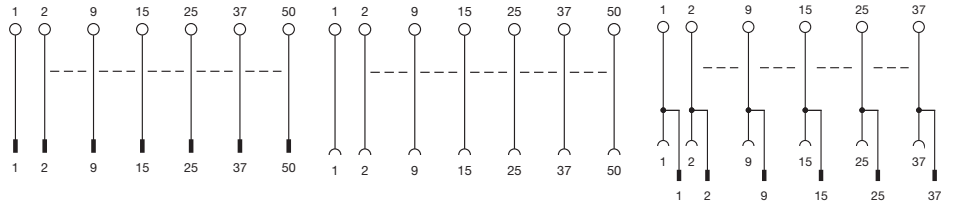

## VERSIONS

## DIMENSIONS

	(A x B x C)
9 poles	37x66x93 (1.46x2.60x3.66 in)
15 poles	47x66x93 (1.85x2.60x3.66 in)
25 poles	70x66x93 (2.76x2.60x3.66 in)
37 poles	107x66x93 (4.21x2.60x3.66 in)

## male

## female

## male + female

Item	Cat. No.	Item	Cat. No.	Item	Cat. No.
ISD09PM (1)	XISD09PM	ISD09PF (1)	XISD09PF	ISD09FM	XISD09FM
ISD15PM (1)	XISD15PM	ISD15PF (1)	XISD15PF	ISD15FM	XISD15FM
ISD25PM (1)	XISD25PM	ISD25PF (1)	XISD25PF	ISD25FM	XISD25FM
ISD37PM (1)	XISD37PM	ISD37PF (1)	XISD37PF	ISD37FM	XISD37FM

## GENERAL TECHNICAL DATA

Rated voltage	0...50 Vac / 0...75 Vdc	0...50 Vac / 0...75 Vdc	0...50 Vac / 0...75 Vdc
Rated current	2 A max.	2 A max.	2 A max.
Operating temperature	-20...+60°C	-20...+60°C	-20...+60°C
Protection degree	IP00 IEC529; EN60529	IP00 IEC529; EN60529	IP00 IEC529; EN60529
Reference Standard	IEC 664-1; DIN VDE 0110.1	IEC 664-1; DIN VDE 0110.1	IEC 664-1; DIN VDE 0110.1
Pollution degree	2	2	2
Overvoltage category	II	II	II
Housing material	polyamide UL94V-0	polyamide UL94V-0	polyamide UL94V-0
Connection terminal blocks	2.5 mm <sup>2</sup> fixed screw type (AWG 14)	2.5 mm <sup>2</sup> fixed screw type (AWG 14)	2.5 mm <sup>2</sup> fixed screw type (AWG 14)
Mounting information	vertical on rail adjacent without gap	vertical on rail adjacent without gap	vertical on rail adjacent without gap

## MOUNTING ACCESSORIES

Mounting rail type according to IEC60715/TH35  
Mounting rail type according to IEC60715/G32  
Jumper bridge black

PR/3/AC - PR/3/AS  
PR/DIN/AC - PR/DIN/AS - PR/DIN/AL

# Passive interfaces (D-Sub/Terminals modules) ISD series

- With LED to display the status

Item available till sell-out

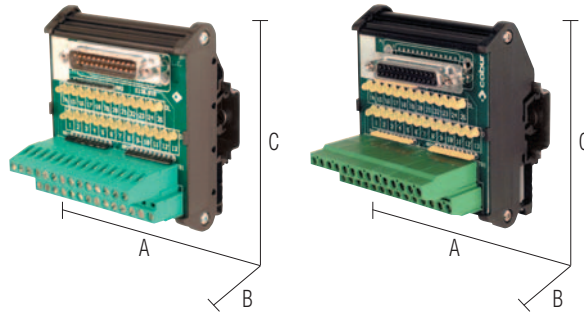

## NOTES

These modules allow the transferring to the terminals of the deriving signals on a cable with D-Sub connector type

The numeration is "pin-to-pin"

(1) The LEDs are predisposed for a nominal voltage of 24 Vdc and negative common.

## BLOCK DIAGRAM

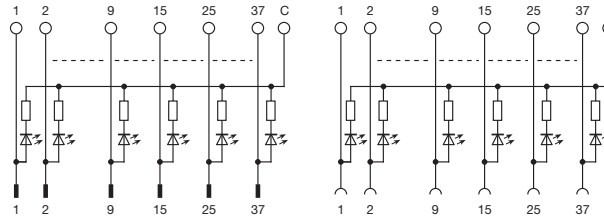

VERSIONS	DIMENSIONS (A x B x C)
25 poles	80x66x93 (3.15x2.60x3.66 in)
37 poles	109x66x93 (4.30x2.60x3.66 in)

male		female	
Item	Cat. No.	Item	Cat. No.
ISD25PML	XISD25PML	ISD25PFL	XISD25PFL
ISD37PML	XISD37PML	ISD37PFL	XISD37PFL

## GENERAL TECHNICAL DATA

Rated voltage	12...24 Vdc ±10% (1)
Rated current	2 A max.
Operating temperature	-20...+60°C
Protection degree	IP00 IEC529; EN60529
Reference Standard	IEC 664-1; DIN VDE 0110.1
Pollution degree	2
Overvoltage category	II
Housing material	polyamide UL94V-0
Connection terminal blocks	2.5 mm <sup>2</sup> fixed screw type (AWG 14)
Mounting information	vertical on rail adjacent without gap

## MOUNTING ACCESSORIES

Mounting rail type according to IEC60715/TH35	PR/3/AC - PR/3/AS
Mounting rail type according to IEC60715/G32	PR/DIN/AC - PR/DIN/AS - PR/DIN/AL
Jumper bridge	black

# Passive interfaces (D-Sub/Terminals modules) CPD series

- Compact dimensions

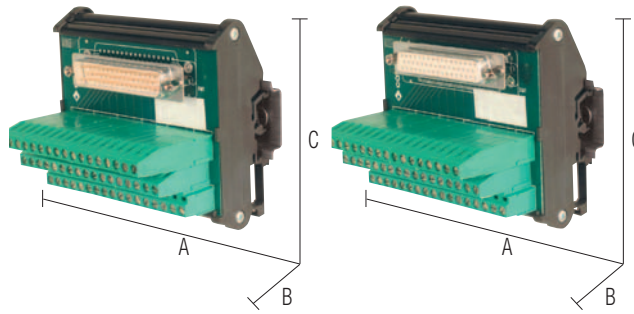

## NOTES

These modules allow the transferring to the terminals of the deriving signals on a cable with D-Sub connector type.  
The numeration is "pin-to-pin".

(1) Version available upon request; for information call our sales department, local agent or representative

## BLOCK DIAGRAM

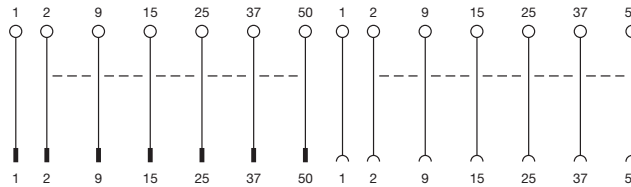

VERSIONS	DIMENSIONS (A x B x C)	male		female	
		Item	Cat. No.	Item	Cat. No.
25 poles	57x80x93 (2.24x3.15x3.66 in)	CPD25M	XCPD25M	CPD25F	XCPD25F
37 poles	77x80x93 (3.03x3.15x3.66 in)	CPD37M	XCPD37M	CPD37F	XCPD37F
50 poles	92x80x93 (3.62x3.15x3.66 in)	CPD50M (1)	XCPD50M	CPD50F (1)	XCPD50F

## GENERAL TECHNICAL DATA

Rated voltage	0...50 Vac / 0...75 Vdc
Rated current	2 A max.
Operating temperature	-20...+60°C
Protection degree	IP00 IEC529; EN60529
Reference Standard	IEC 664-1; DIN VDE 0110.1
Pollution degree	2
Overvoltage category	II
Housing material	polyamide UL94V-0
Connection terminal blocks	2.5 mm <sup>2</sup> fixed screw type (AWG 14)
Mounting information	vertical on rail adjacent without gap

## MOUNTING ACCESSORIES

Mounting rail type according to IEC60715/TH35	PR/3/AC - PR/3/AS
Mounting rail type according to IEC60715/G32	PR/DIN/AC - PR/DIN/AS - PR/DIN/AL
Jumper bridge	black —

# Passive interfaces (I.D.C./Terminal blocks) IF series

- Available with LED to display the status

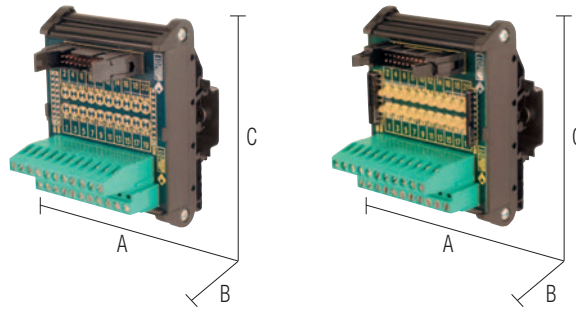

## NOTES

The modules allow the transferring to the terminals the deriving signals on Flat-cable through the employment of IDC ribbon cable connectors (with insulation displacement).

The numeration is "pin-to-pin".

(1) Version available upon request; for information call our sales department, local agent or representative

(2) The LEDs are predisposed for a nominal voltage of 24 Vdc and negative common

## BLOCK DIAGRAM

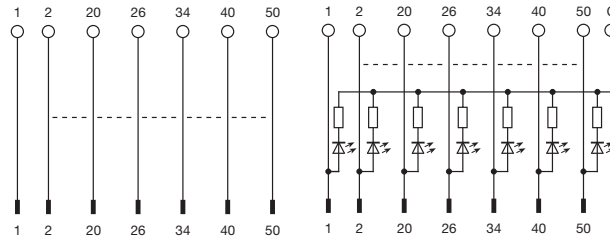

VERSIONS	DIMENSIONS (A x B x C)	Without LED		With LED	
		Item	Cat. No.	Item	Cat. No.
10 poles	42x66x93 (1.65x2.60x3.66 in)	IF10PMS (1)	XIF10PMS	IF10PML (1)	XIF10PML
14 poles	48x66x93 (1.89x2.60x3.66 in)	IF14PMS (1)	XIF14PMS	IF14PML (1)	XIF14PML
16 poles	58x66x93 (2.28x2.60x3.66 in)	IF16PMS (1)	XIF16PMS	IF16PML (1)	XIF16PML
20 poles	70x66x93 (2.76x2.60x3.66 in)	IF20PMS (1)	XIF20PMS	IF20PML (1)	XIF20PML
26 poles	86x66x93 (3.39x2.60x3.66 in)	IF26PMS (1)	XIF26PMS	IF26PML (1)	XIF26PML
34 poles	107x66x93 (4.21x2.60x3.66 in)	IF34PMS (1)	XIF34PMS	IF34PML (1)	XIF34PML
40 poles	122x66x93 (4.80x2.60x3.66 in)	IF40PMS (1)	XIF40PMS	IF40PML (1)	XIF40PML

## GENERAL TECHNICAL DATA

Rated voltage	0...50 Vac / 0...75 Vdc	12...24 Vdc ±10% (2)
Rated current	750 mA max.	750 mA max.
Operating temperature	-20...+60°C	-20...+60°C
Protection degree	IP00 IEC529; EN60529	IP00 IEC529; EN60529
Reference Standard	IEC 664-1; DIN VDE 0110.1	IEC 664-1; DIN VDE 0110.1
Pollution degree	2	2
Overvoltage category	II	II
Housing material	polyamide UL94V-0	polyamide UL94V-0
Connection terminal blocks	2.5 mm <sup>2</sup> fixed screw type (AWG 14)	2.5 mm <sup>2</sup> fixed screw type (AWG 14)
Mounting information	vertical on rail adjacent without gap	vertical on rail adjacent without gap

## MOUNTING ACCESSORIES

Mounting rail type according to IEC60715/TH35	
Mounting rail type according to IEC60715/G32	
Jumper bridge	black

## PR/3/AC - PR/3/AS

PR/DIN/AC - PR/DIN/AS - PR/DIN/AL



# Passive interfaces (I.D.C./Terminal blocks) CPC series

- Compact dimensions

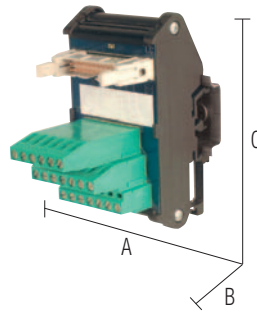

## NOTES

The modules allow the transferring to the terminals of the deriving signals on Flat-cable through the employment of IDC ribbon cable connectors (with insulation displacement).

The numeration is "pin-to-pin".

(1) Version available upon request; for information call our sales department, local agent or representative.

## BLOCK DIAGRAM

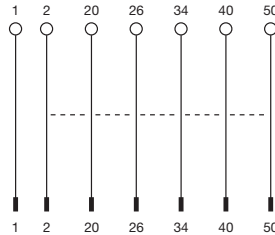

VERSIONS	DIMENSIONS (A x B x C)	without LED	
		Item	Cat. No.
20 poles	47x80x93 (1.85x3.15x3.66 in)	CPC20M	XCPC20M
26 poles	57x80x93 (2.24x3.15x3.66 in)	CPC26M	XCPC26M
34 poles	70x80x93 (2.76x3.15x3.66 in)	CPC34M (1)	XCPC34M
40 poles	77x80x93 (3.03x3.15x3.66 in)	CPC40M	XCPC40M
50 poles	92x80x93 (3.62x3.15x3.66 in)	CPC50M (1)	XCPC50M
60 poles	107x80x93 (4.21x3.15x3.66 in)	CPC60M (1)	XCPC60M
64 poles	117x80x93 (4.61x3.15x3.66 in)	CPC64M (1)	XCPC64M

## GENERAL TECHNICAL DATA

Rated voltage	0...50 Vac / 0...75 Vdc
Rated current	750 mA max.
Operating temperature	-20...+60°C
Protection degree	IP00 IEC529; EN60529
Reference Standard	IEC 664-1; DIN VDE 0110.1
Pollution degree	2
Overvoltage category	II
Housing material	polyamide UL94V-0
Connection terminal blocks	2.5 mm <sup>2</sup> fixed screw type (AWG 14)
Mounting information	vertical on rail adjacent without gap

## MOUNTING ACCESSORIES

Mounting rail type according to IEC60715/TH35	PR/3/AC - PR/3/AS
Mounting rail type according to IEC60715/G32	PR/DIN/AC - PR/DIN/AS - PR/DIN/AL
Jumper bridge	black

# Component-holders modules CCM series

- Compact dimensions
- Available with fast-on connection

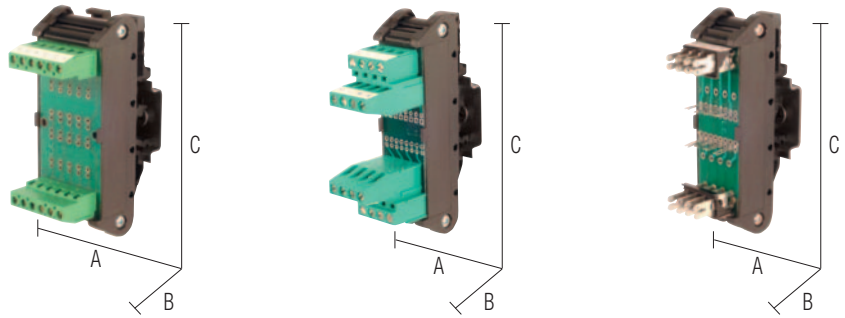

## NOTES

The component-holders modules allow the montage of electronic components (diodes, resistors, capacitors etc.) according to customer needs.

They are available with connections with terminal blocks or Faston, and with holes of different diameters for the terminals of the components.

(1) Version available upon request; for info call our sales dept., local agent or representative

## BLOCK DIAGRAM

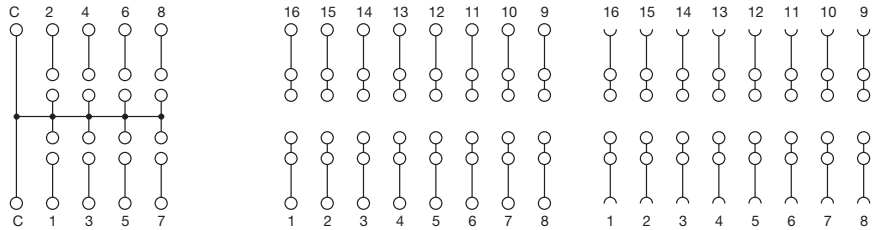

VERSIONS	DIMENSIONS (A x B x C)	with common terminal		single with terminals		single with Faston	
		Item	Cat. No.	Item	Cat. No.	Item	Cat. No.
4 components (1)	25x66x93 (0.98x2.60x3.66 in)	—	—	—	—	CCM04SF	XCCM04SF
8 components (1)	25x66x93 (0.98x2.60x3.66 in)	—	—	CCM08SV	XCCM08SV	—	—
8 components (1)	47x66x93 (1.85x2.60x3.66 in)	—	—	—	—	CCM08SF	XCCM08SF
8 components (1)	25x55x93 (0.98x2.17x3.66 in)	CCM08CV	XCCM08CV	—	—	—	—
12 components (1)	70x66x93 (2.76x2.60x3.66 in)	—	—	—	—	CCM12SF	XCCM12SF
16 components (1)	47x66x93 (1.85x2.60x3.66 in)	CCM16CV	XCCM16CV	CCM16SV	XCCM16SV	—	—
24 components (1)	70x66x93 (2.76x2.60x3.66 in)	—	—	CCM24SV	XCCM24SV	—	—

## GENERAL TECHNICAL DATA

Rated voltage	0...220 V ±10%	0...100 V ±10%	0...100 V ±10%
Rated current	5 A (channel) / 15 A (common)	2 A max. (on the common)	2 A max. (on the common)
Operating temperature	-20...+60°C	-20...+60°C	-20...+60°C
Protection degree	IP00 IEC529; EN60529	IP00 IEC529; EN60529	IP00 IEC529; EN60529
Reference Standard	IEC 664-1; DIN VDE 0110.1	IEC 664-1; DIN VDE 0110.1	IEC 664-1; DIN VDE 0110.1
Pollution degree	2	2	2
Oversoltage category	II	II	II
Housing material	polyamide UL94V-0	polyamide UL94V-0	polyamide UL94V-0
Connection terminal blocks	2.5 mm <sup>2</sup> fixed screw type (AWG 14)	2.5 mm <sup>2</sup> fixed screw type (AWG 14)	2.5 mm <sup>2</sup> fixed screw type (AWG 14)
Mounting information	vertical on rail adjacent without gap	vertical on rail adjacent without gap	vertical on rail adjacent without gap

## MOUNTING ACCESSORIES

Mounting rail type according to IEC60715/TH35	
Mounting rail type according to IEC60715/G32	
Jumper bridge	black

PR/3/AC - PR/3/AS  
PR/DIN/AC - PR/DIN/AS - PR/DIN/AL

The PMC series has changed its Cat. No. into CCM series, these are the cross reference list.

Old item	New item
PMC0001	CCM08CV
PMC0002	CCM08SV
PMC0003	CCM16SV
PMC0004	CCM24SV
PMC0005	CCM04SF
PMC0006	CCM08SF
PMC0007	CCM12SF

# Diode-holder modules with single diodes CDM series

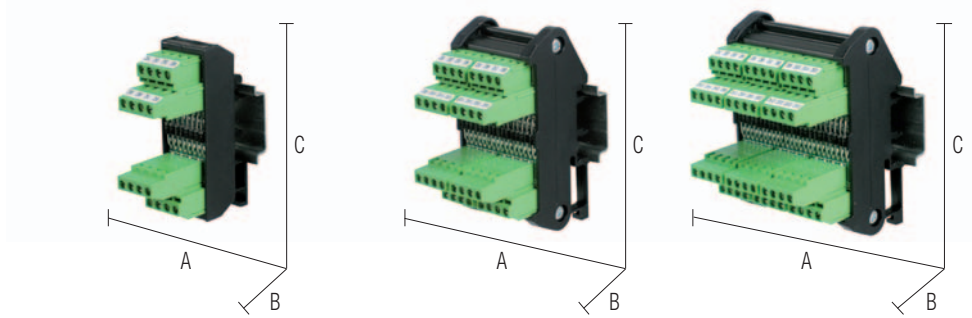

## NOTES

## BLOCK DIAGRAM

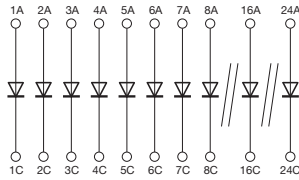

VERSIONS	DIMENSIONS (A x B x C)	single diode	
		Item	Cat. No.
8 diodes	25x60x76 (0.98x2.36x3.66 in)	CDM08CS	XCDM08CS
16 diodes	50x65x93 (1.97x2.56x3.66 in)	CDM16CS	XCDM16CS
24 diodes	71x65x93 (2.80x2.56x3.66 in)	CDM24CS	XCDM24CS

## GENERAL TECHNICAL DATA

Rated voltage	0...100 V ±10%
Rated current	1 A max.
Diode type	1N4007
Repetitive peak reverse voltage	1000 V
Operating temperature	-20...+60°C
Protection degree	IP00 IEC529; EN60529
Reference Standard	IEC 664-1; DIN VDE 0110.1
Pollution degree	2
Overvoltage category	II
Housing material	polyamide UL94V-0
Connection terminal blocks	2.5 mm <sup>2</sup> fixed screw type (AWG 14)
Mounting information	vertical on rail adjacent without gap

## MOUNTING ACCESSORIES

Mounting rail type according to IEC60715/TH35	PR/3/AC - PR/3/AS
Mounting rail type according to IEC60715/G32	PR/DIN/AC - PR/DIN/AS - PR/DIN/AL
Jumper bridge	black —

# Diode-holder modules with common terminal CDM series

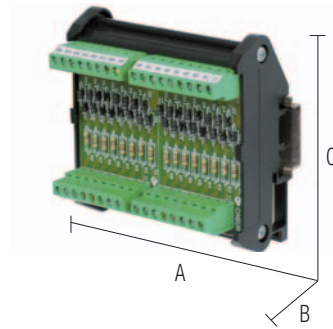

## NOTES

## BLOCK DIAGRAM

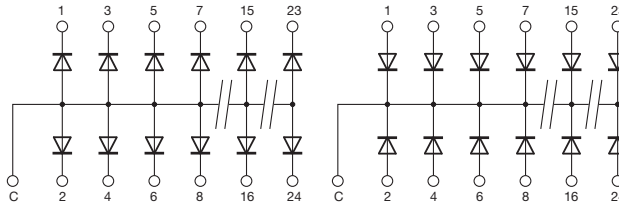

VERSIONS	DIMENSIONS (A x B x C)	common anode		common cathode	
		Item	Cat. No.	Item	Cat. No.
8 diodes	45x65x93 (1.77x2.56x3.66 in)	CDM08AC	XCDM08AC	CDM08CC	XCDM08CC
16 diodes	92x65x93 (3.62x2.56x3.66 in)	CDM16AC	XCDM16AC	CDM16CC	XCDM16CC
24 diodes	137x65x93 (5.39x2.56x3.66 in)	CDM24AC	XCDM24AC	CDM24CC	XCDM24CC

## GENERAL TECHNICAL DATA

Rated voltage	0...230 V ±10%
Rated current	1 A (channel) / 15 A (common).
Operating temperature	1N4007
Diode type	1000 V
Repetitive peak reverse voltage	-20...+60°C
Protection degree	IP00 IEC529; EN60529
Reference Standard	IEC 664-1; DIN VDE 0110.1
Pollution degree	2
Overvoltage category	II
Housing material	polyamide UL94V-0
Connection terminal blocks	2.5 mm <sup>2</sup> fixed screw type (AWG 14)
Mounting information	vertical on rail adjacent without gap

## MOUNTING ACCESSORIES

Mounting rail type according to IEC60715/TH35	PR/3/AC - PR/3/AS
Mounting rail type according to IEC60715/G32	PR/DIN/AC - PR/DIN/AS - PR/DIN/AL
Jumper bridge	black

# LED testing modules CLT series

- Compact dimensions
- Integrated limitation resistance
- Suitable only for LED without resistance limiter
- Not suitable for LED lamp with internal limiter circuit

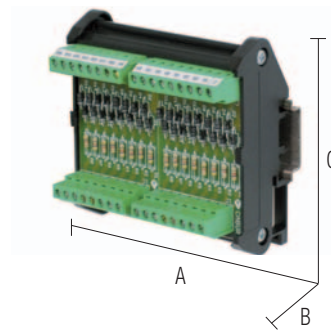

## NOTES

- (1) Led test can be performed through a negative signal on the common output  
 (2) Led test can be performed through a positive signal on the common input  
 (3) Version available upon request; for information call our sales department, local agent or representative

## BLOCK DIAGRAM

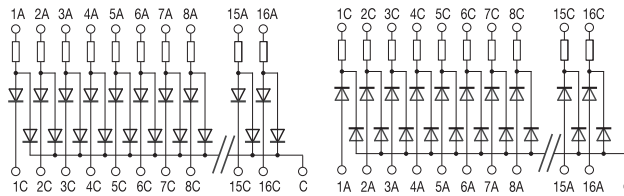

VERSIONS	DIMENSIONS (A x B x C)
8 channels	45x65x93 (1.77x2.56x3.66 in)
16 channels	92x65x93 (3.62x2.56x3.66 in)

common negative (1)		common positive (2)	
Item	Cat. No.	Item	Cat. No.
CLT08AC (3)	XCLT08AC	CLT08CC (3)	XCLT08CC
CLT16AC (3)	XCLT16AC	CLT16CC (3)	XCLT16CC

### GENERAL TECHNICAL DATA

Rated voltage	24 Vdc max. 30 Vdc
Rated current (1 channel)	5 mA @ 24 Vdc
Diode type	1N4007
Limitation resistance	4,7 kΩ 1/4 W ±5%
Repetitive peak reverse voltage	1000 V
Operating temperature	-20...+45°C
Housing material	polyamide UL94V-0
Protection degree	IP 00 IEC529, EN60529
Connection terminal blocks	2.5 mm <sup>2</sup> fixed screw type
Mounting information	vertical on rail adjacent without gap

### MOUNTING ACCESSORIES

Mounting rail type according to IEC60715/TH35	
Mounting rail type according to IEC60715/G32	
Jumper bridge	black

PR/3/AC – PR/3/AC/ZB – PR/3/AS – PR/3/AS/ZB	
PR/DIN/AC - PR/DIN/AS - PR/DIN/AL	
—	

# Lamp testing modules CLP series

- Compact dimensions
- Suitable also for LED lamp with resistance limiter

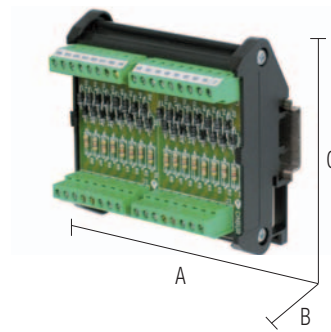

## NOTES

With AC input, the diodes rectify the current and the power will be halved.

- (1) Led test can be performed through a negative signal on the common output
- (2) Led test can be performed through a positive signal on the common input

## BLOCK DIAGRAM

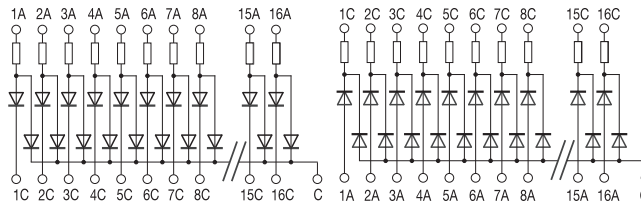

VERSIONS	DIMENSIONS (A x B x C)	common negative (1)		common positive (2)	
		Item	Cat. No.	Item	Cat. No.
8 channels	45x65x93 (1.77x2.56x3.66 in)			CLP08CC	XCLP08CC
16 channels	92x65x93 (3.62x2.56x3.66 in)			CLP16CC	XCLP16CC

## GENERAL TECHNICAL DATA

Rated voltage	230 Vac/dc
Rated current (1 channel)	100 mA @ 120 Vac/dc; 50 mA @ 230 Vac/dc
Diode type	1N4007
Limitation resistance	0
Repetitive peak reverse voltage	700 V
Operating temperature	-20...+45°C
Housing material	polyamide UL94V-0
Protection degree	IP 00 IEC529, EN60529
Connection terminal blocks	2.5 mm <sup>2</sup> fixed screw type
Mounting information	vertical on rail adjacent without gap

## MOUNTING ACCESSORIES

Mounting rail type according to IEC60715/TH35	PR/3/AC – PR/3/AC/ZB – PR/3/AS – PR/3/AS/ZB
Mounting rail type according to IEC60715/G32	PR/DIN/AC - PR/DIN/AS - PR/DIN/AL
Jumper bridge	black



# Housing for custom applications CH series

• Available on 3 measures

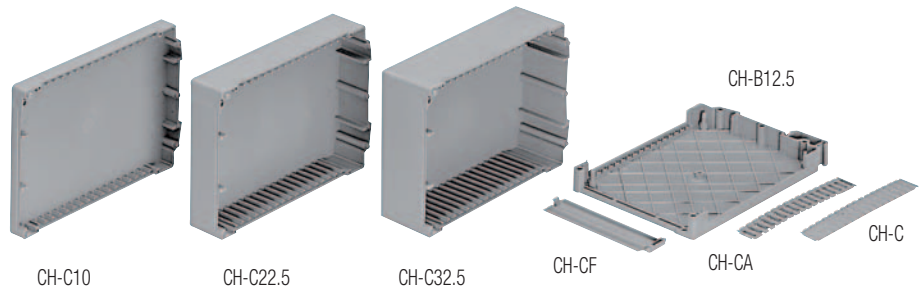

## NOTES

(1) Maximum height of the components measured between the circuit and the cover

## BLOCK DIAGRAM

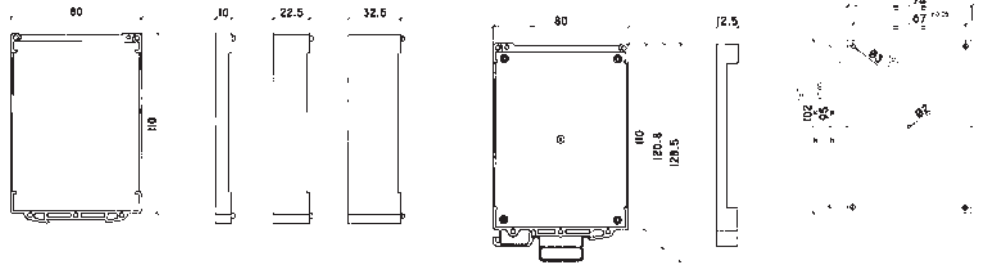

## VERSIONS

Right side with hook for DIN rail, 12.5 mm
Left side housing, 10 mm
Left side housing, 22.5 mm
Left side housing, 32.5 mm
Openable hinged cover
Vented cover
Enclosed cover
fixed hinged cover

Item	Cat. No.
CH-B12.5	XBB125
CH-C10	XBC010
CH-C22.5	XBC225
CH-C32.5	XBC325
CH-S	XBS000
CH-CA	XBCA00
CH-C	XBC000
CH-CF	XBCF00

## APPLICATIONS

### CH electronic housings

With the CH (Cabur Housing) series containers, Cabur proposes a modular system which allows you to obtain boxes with 3 width sizes 22.5 mm - 35 mm - 45 mm - composed by 8 easy-to-assemble parts.

The circuit can have a maximum size of 102 x 74 mm and can be inserted on 4 small columns formed in the base which holds it in position.

Additional anchorage of the circuit is possible with a 2.2 x 4.5 mm self-threading screw to be screwed into the central column, also allowing small circuit to be mounted.

The conductors are connected with 2.5 mm pluggable terminals, which are readily available.

16 connection poles which can be used with pitch of 5.08 on each side and 10 on the front side.

The CH-S front closure, with panel opening, provides access to the internal circuit for work on the potentiometers, jumpers and micro-switches.

The side covers are available with ventilating holes or closed, and are pre-cut with 5.08 mm pitch, to make possible an easy cut into necessary length with a pair of scissors, for an easy fit to final dimensions.

The following are required for a composition of a housing::

- 1 CH-B12.5 base 12.5 mm wide
- 1 cover (3 sizes available)
 

CH-C10	10 mm wide
CH-C22.5	22.5 mm wide
CH-C32.5	32.5 mm wide

(by adding together the width of the base 12.5 mm with the width of the cover chosen from the 4 available, the total width of the housing is obtained)

- 1 front closure in two versions:
 

CH-S	with panel opening
CH-CF	fixed
- 2 side closures in two versions:
 

CH-C	without vents
CH-CA	with vents

## GENERAL TECHNICAL DATA

Material	Poliamide UL94V-0
Colour	RAL 5014
Temperature	max 80 °C
Dissipated power	max 7 W
Protection degree	fino a IP30
Number of poles for every side	16 +16 (5.08)
Number of poles on the top	10 (5.08)
Mounting information	

## MOUNTING ACCESSORIES

Mounting rail type according to IEC60715/TH35-7.5	PR/3/AC, PR/3/AS
Mounting rail type according to IEC60715/G32	—
Jumper bridge	red — white — blue —

Interior height max (1)	CH-B12.5	CH-C10	CH-C22.5	CH-C32.5	CH-S	CH-CA CH-C
19.1 mm	1	1			1	2
31.6 mm	1		1		1	2
41.6 mm	1			1	1	2

# Housing for custom applications CK series

- 6 mm wide, expandable modules
- 6 spring-clamp 2,5 mm<sup>2</sup> / AWG 26 ÷ 14 terminal blocks
- Jumper insertion possibility on each of the 4 levels
- Hinged front cover access to the printed circuit board

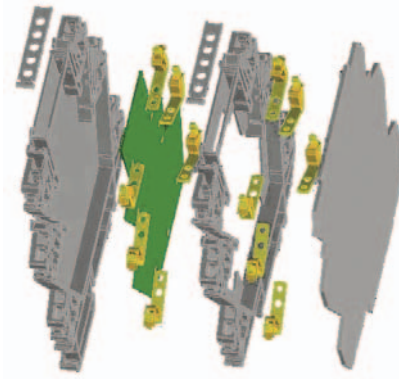

## NOTES

- (1) 6 spring-clamp terminal blocks included with solder contact
- (2) In order to assure the IP20 protection degree, the last module must be protected and insulated using the CK/PT end section

## BLOCK DIAGRAM

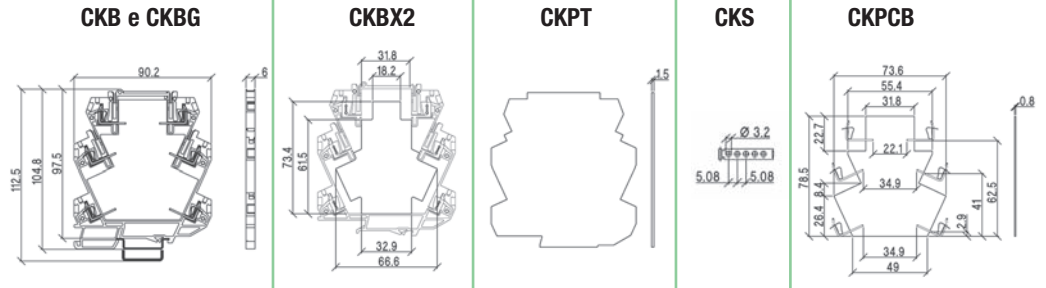

## VERSIONS

- Standard base
- Base element with ground contact
- Expansion module
- End section
- Front hinge cover
- Printed circuit board

Item	Cat. No.
CKB (1)	XCKB
CKBG (1)	XCKBG
CKBX2 (1)	XCKX2
CK/PT	XCKPT
CK/S	XCKS
CK/PCB	8901028

## APPLICATIONS

With the CK series modular housings, Cabur offers a modular system that provides housings with increasing dimensions in width for simple components as diodes, resistors or more complex circuits with or without the support of a printed circuit board. For the composition of an housing the following items are necessary:

- a base support element, available in two versions: CKB and CKBG; the latter is provided with an electric metal contact on the DIN rail that allows to connect the internal circuit to the ground. Ground contact towards the DIN rail can carry an impulsive current value of 5 KA (8/20 peak). Both models have an external width of 6 mm and internal width of 5 mm; they are also equipped with 6 springclamp terminal blocks and 4 slots for the insertion of a jumper;
- one or more CKBX2 type expansion modules similar to the base support element, having therefore an external width of 6 mm and a central slot that allows the housing of the bulky components with a height exceeding the overall height of the base support element; the expansion module is also equipped with 6 spring-clamp terminal blocks and 4 slots for the insertion of a jumper;
- the CK/S front cover, granting access to the interior of the product, is also available. Once in open position it has such a dimension in order to guarantee a IPXXB degree of protection, even when it is not employed;
- in order to assure the IPXXB protection degree, the last module must be protected and insulated using the CK/PT end section;
- the CK/PCB printed circuit board is also available; it is useful in low volume custom applications where a special pcb is not designed and also where one requires a prototype without tooling a special printed circuit board.

## GENERAL TECHNICAL DATA

Rated voltage of each terminal block	230 Vac/dc ± 10%
Rated current of each terminal block	≤ 24 A
Operating temperature	-40...+ 100°C
Protection degree (2)	IP20 IEC529 EN60529
Connection terminals	2.5 mm <sup>2</sup> , AWG26-14 spring type
Housing material	polyamide UL 94V0
Approx. weight	20 g (CKB, CKBG), 15 g (CKX2, CK/PT) 20 g (CK/PT), 1 g (CK/S), 5 g (CK/PCB)
Parallel bridge	<b>PTC/CK/42</b> Cat. No. PTCCK42 (42 poli)
Marking tags	<b>CNU/8/030</b> Cat. No. NU0851
Mounting information	on rail

## MOUNTING ACCESSORIES

Mounting rail type according to IEC60715/TH35-7.5	<b>PR/3/AC, PR/3/AC/ZB, PR/3/AS, PR/3/AS/ZB</b>
Mounting rail type according to IEC60715/G32	—
Jumper bridge	red white blue

Ground contact on CKBG



CKBX2

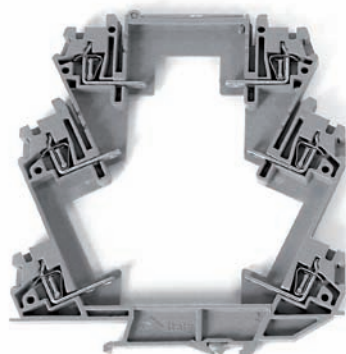

CKB

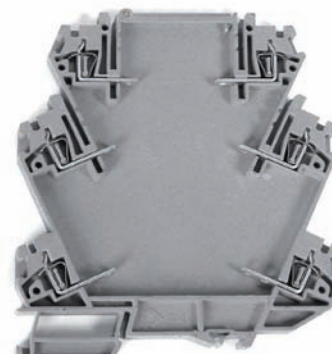

CK/PCB

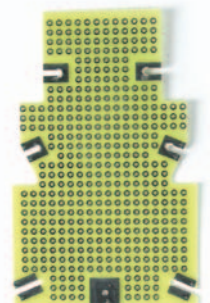

## Plug-in jumper for CK series

### Notes:

- (1) Example of a pre-cut 9 position jumper
- (2) CK/PT end section must be mounted on last module to assure IP20 protection degree
- (3) 32 A is the maximum current; however this value is limited by the rated current of the spring-clamp terminal blocks down to 24 A; for instance, having a jumper of 11 poles (1 for common and 10 for distribution) a current of 2.4 A can be distributed on every poles



VERSIONS	Item	Cat. No.
	PTC/CK/42	PTCCK42
GENERAL TECHNICAL DATA		
Protection degree (2)	IP20 IEC529; EN60529	
Number of poles	42	
Pitch	6 mm (0.24 in)	
Rated current carrying capacity of jumper (3)	32 A	
Insulation color	—	
Material	tin copper alloy	
Approx. weight	27 g (0.95 oz) (42 poles)	

## Plug-in jumper for CW..7 series



VERSIONS	Item	Cat. No.	Item	Cat. No.	Item	Cat. No.
	CWBK 7-0802	X766802	CWBK 7-0803	X766803	CWBK 7-0804	X766804
GENERAL TECHNICAL DATA						
Protection degree	IP20 IEC529; EN60529		IP20 IEC529; EN60529		IP20 IEC529; EN60529	
Number of poles	16		16		16	
Pitch	6.2 mm (2.44 in)		6.2 mm (2.44 in)		6.2 mm (2.44 in)	
Rated current carrying capacity of jumper	16 A		16 A		16 A	
Insulation color	red		white		blue	
Material	—		—		—	
Approx. weight	4 g (0.14 oz)		4 g (0.14 oz)		4 g (0.14 oz)	

## Plug-in jumper for CWRE series



VERSIONS	Item	Cat. No.
	CWBK 7-0813	X766813
GENERAL TECHNICAL DATA		
Protection degree	IP20 IEC529; EN60529	
Number of poles	20	
Pitch	6.2 mm (2.44 in)	
Rated current carrying capacity of jumper	16 A	
Insulation color	blue	
Material	—	
Approx. weight	6 g (0.21 oz)	

## Screw type jumper for CM series

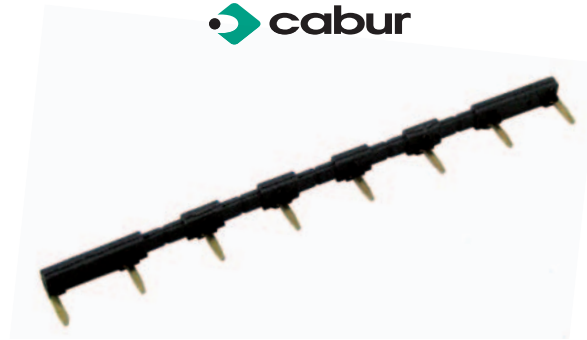

VERSIONS	Item	Cat. No.	Item	Cat. No.
	CMB16B	XCMB16B	CMB27B	XCMB27B

GENERAL TECHNICAL DATA	
Protection degree	IP20 IEC529; EN60529
Number of poles	8
Pitch	16 mm (0.63 in)
Rated current carrying capacity of jumper	16 A
Insulation color	black
Material	—
Approx. weight	3 g (0.10 oz)

## Marking systems

### Note:

White polycarbonate marking tags to number the terminal blocks of the CK Series modules and CWRE Series converters. To be directly inserted in dedicated holders before or after terminal board preparation. They come in packages of 15 modules of 100 marking tags each, for a total of 1,500 marking tags. The table shows only blank marking tags, available in packages of 1,500 pieces each, which can be written on manually using special pens or printed using an industrial marking system. In particular, **the marking tags shown here can be printed using the innovative CaburJet system and with the CaburPlot plotter.**

In addition to blank marking tags, CNU/8/51 preprinted marking tags are also available with alpha-numeric characters and with the most common electrical symbols.

For more information, please consult the Industrial Marking Systems catalogue.

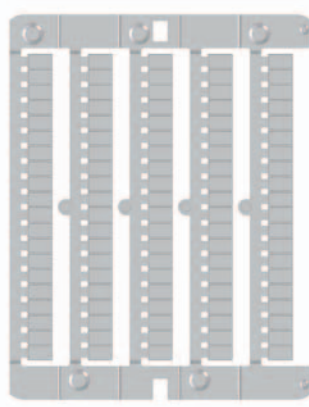

Type **CNU/8/51** code NU0851

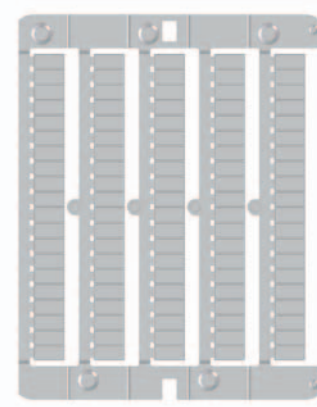

Type **NUPUTUK50** code NUPUTUK50

Description	Sigle	Code
Marking tags for marking CK Series modules	<b>CNU/8/51</b>	NU0851
Marking tags for marking CWRE Series converters	<b>NUPUTUK50</b>	NUPUTUK50

## Bracket for power supplies

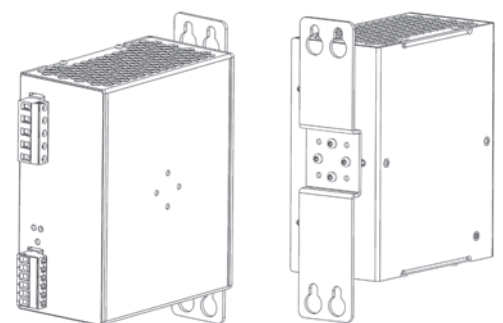
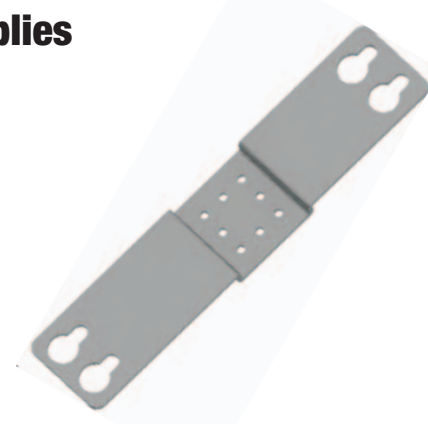

VERSIONS	Sigle	Code	DIMENSION
	CDIWMP	XCDIWMP	

GENERAL TECHNICAL DATA	
Type of material	P13-FE00 aluminium
Treatment	"SENDZMIR" system
Mounting information	screws or rivets

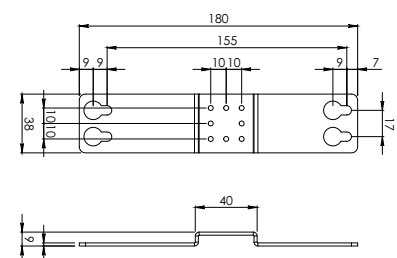

# DIN rail clamp



## DIMENSION

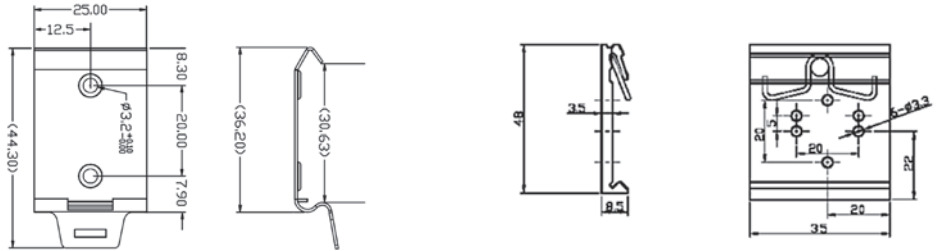

VERSIONS	Item	Cat. No.	Item	Cat. No.
	CDIN-2	XCDIN2	CDIN-4	XCDIN4

## GENERAL TECHNICAL DATA

Type of material	P13-FE00	aluminium
Treatment	black passivated	—
Mounting information	screws or rivets	screws or rivets
Mounting rail type according to IEC60715/TH35-7.5	PR/3/AC, PR/3/AC/ZB, PR/3/AS, PR/3/AS/ZB	PR/3/AC, PR/3/AC/ZB, PR/3/AS, PR/3/AS/ZB
Mounting rail type according to IEC60715/G32	—	—

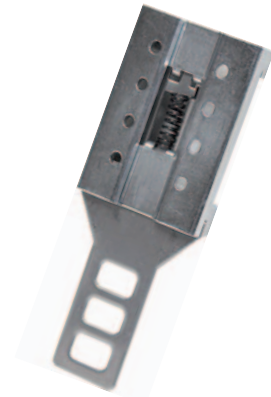

## DIMENSION

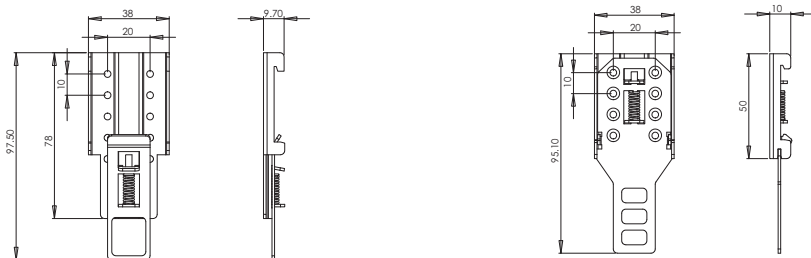

VERSIONS	Item	Cat. No.	Item	Cat. No.
	CDIN-5	XCDIN5	CDINM45	XCDINM45

## GENERAL TECHNICAL DATA

Type of material	P13-FE00	P13-FE00
Treatment	white zinc-plated	zinc-plated
Mounting information	screws or rivets	screws
Mounting rail type according to IEC60715/TH35-7.5	PR/3/AC, PR/3/AC/ZB, PR/3/AS, PR/3/AS/ZB	PR/3/AC, PR/3/AC/ZB, PR/3/AS, PR/3/AS/ZB
Mounting rail type according to IEC60715/G32	—	—



## Mounting rails

- according to IEC 60715/TH35 - 7,5
- according to IEC 60715/TH35 - 15
- supports for TH/35 type rail



DESCRIPTION	TYPE / CAT. NO.	BLOCK DIAGRAMS
<b>IEC 60715/TH35 - 7.5 rail</b> of passivated steel	<b>PR/3/AC</b>  Cat. No. PR003	
<b>IEC 60715/TH35 - 7.5 rail</b> of white zinc-plated steel "SENDZMIR" system	<b>PR/3/AC/ZB</b>  Cat. No. PR903	
<b>IEC 60715/TH35 - 7.5 rail</b> of passivated steel with slots	<b>PR/3/AS</b>  Cat. No. PR005	
<b>IEC 60715/TH35 - 7.5 rail</b> of white zinc-plated steel "SENDZMIR" system with slots	<b>PR/3/AS/ZB</b>  Cat. No. PR905	
<b>IEC 60715/TH35 - 15 rail</b> of passivated steel	<b>PR/3/PP</b>  Cat. No. PR007	
<b>IEC 60715/TH35 - 15 rail</b> of white zinc-plated steel "SENDZMIR" system	<b>PR/3/PP/ZB</b>  Cat. No. PR907	
<b>IEC 60715/TH35 - 15 rail</b> of passivated steel with slots	<b>PR/3/PA</b>  Cat. No. PR006	
<b>IEC 60715/TH35 - 15 rail</b> of white zinc-plated steel "SENDZMIR" system with slots	<b>PR/3/PA/ZB</b>  Cat. No. PR906	
<b>Support for IEC 60715/TH35 rail</b> of nickel plated steel and with rapid mounting system 4 MA	<b>ACI121017</b>  Cat. No. Z121017	
<b>Support for IEC 60715/TH35 rail</b> of nickel plated steel and with rapid mounting system 5 MA	<b>ACI121019</b>  Cat. No. Z121019	



## Mounting rails

- according to IEC 60715 “G32” type rail
- according to IEC 60715/TH15 - 5.5

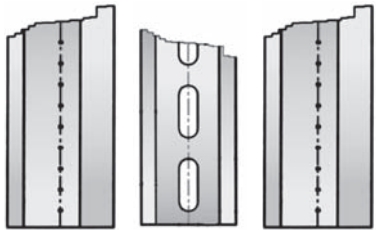
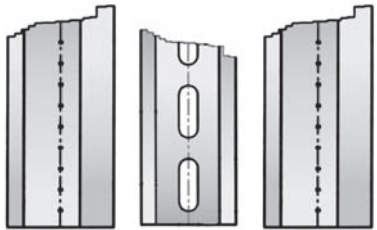
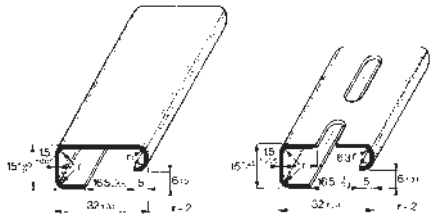
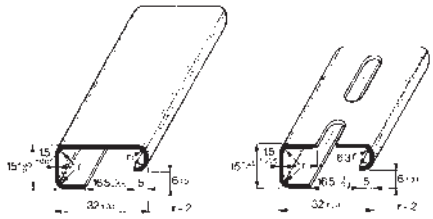
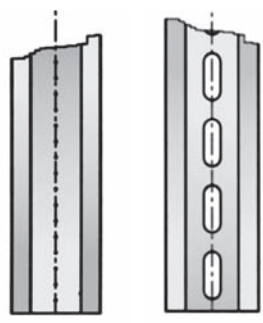
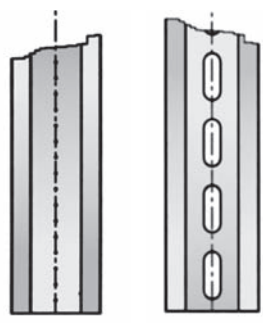
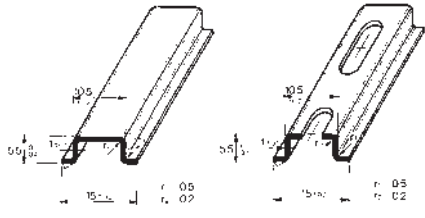
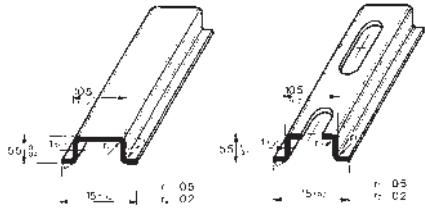

DESCRIPTION	TYPE / CAT. NO.	IMAGES
<b>IEC 60715 “G32” type rail</b> of passivated steel	<b>PR/DIN/AC</b> Cat. No. PR001	
<b>IEC 60715 “G32” type rail</b> of white zinc-plated steel “SENDZMIR” system	<b>PR/DIN/AC/ZB</b> Cat. No. PR901	
<b>IEC 60715 “G32” type rail</b> of passivated steel with slots	<b>PR/DIN/AS</b> Cat. No. PR004	
<b>IEC 60715 “G32” type rail</b> of white zinc-plated steel “SENDZMIR” system with slots	<b>PR/DIN/AS/ZB</b> Cat. No. PR904	
<b>IEC 60715 “G32” type rail</b> of aluminium	<b>PR/DIN/AL</b> Cat. No. PR002	
<b>IEC 60715/TH15 – 5.5 rail</b> of passivated steel	<b>PR/2/AC</b> Cat. No. PR009	
<b>IEC 60715/TH15 – 5.5 rail</b> of white zinc-plated steel “SENDZMIR” system	<b>PR/2/AC/ZB</b> Cat. No. PR909	
<b>IEC 60715/TH15 – 5.5 rail</b> of passivated steel with slots	<b>PR/2/AS</b> Cat. No. PR010	
<b>IEC 60715/TH15 – 5.5 rail</b> of white zinc-plated steel “SENDZMIR” system with slots	<b>PR/2/AS/ZB</b> Cat. No. PR910	

# Alphabetical index

TYPE	PAGE	TYPE	PAGE	TYPE	PAGE	TYPE	PAGE
ACI121017	157	COP082	140	CWAA7-0537	86	PR/2/AC	158
ACI121019	157	CPC20M	146	CWAA7-0538	86	PR/2/AC/ZB	158
AR1	50	CPC26M	146	CWBK7-0802	154	PR/2/AS	158
AR6	50	CPC34M	146	CWBK7-0803	154	PR/2/AS/ZB	158
BATT112V1,2AH	56	CPC40M	146	CWBK7-0804	154	PR/3/AC	157
BY7-40/1-275	62	CPC50M	146	CWBK7-0813	154	PR/3/AC/ZB	157
BY7-40/1-440	62	CPC60M	146	CWCV7-6184	98	PR/3/AS	157
BY7-NPE/40-275	62	CPC64M	146	CWNAA6-0510	83	PR/3/AS/ZB	157
BY7-NPE/40-440	62	CPD25F	144	CWNAA7-0539	83	PR/3/PA	157
CAPIPO3	81	CPD25M	144	CWNFA6-0524	97	PR/3/PA/ZB	157
CCIS2	93	CPD37F	144	CWOT6-2082	136	PR/3/PP	157
CCM04SF	147	CPD37M	144	CWOT6-2083	135	PR/3/PP/ZB	157
CCM08CV	147	CPD50F	144	CWPAA7-0526	87	PR/DIN/AC	158
CCM08SF	147	CPD50M	144	CWPAA7-0527	87	PR/DIN/AC/ZB	158
CCM08SV	147	CR4-1	122	CWPT6-0816	91	PR/DIN/AL	158
CCM12SF	147	CR4-2SC	123	CWPT6-0817	91	PR/DIN/AS	158
CCM16CV	147	CR8-1	122	CWRE7-0842	110	PR/DIN/AS/ZB	158
CCM16SV	147	CR8-3	126	CWRE7-0845	110	PTC/CK/42	154
CCM24SV	147	CRE4-1	122	CWRE7-0846	110	R161E11A	120
CDIN-2	156	CRE4-2SC	123	CWRE7-0847	110	R161E22A	121
CDIN-4	156	CRE8-1	122	CWRE7-0848	110	R161E24	112
CDIN-5	156	CRE8-3	126	CWTH6-0844	92	R161E24P	113
CDINM45	156	CSA120BC	46	CWTH6-0847	92	R161EAD	114
CDIWMP2	155	CSA120BD	46	CWUAA6-0516	82	R161S24F	139
CDM08AC	149	CSA120CB	46	CWUAA6-0517	82	R161U24F	115
CDM08CC	149	CSA120CC	46	F03DKBG5B	74	R162E24	116
CDM08CS	148	CSA120DB	47	F03DPCG5C	75	R162E24P	117
CDM16AC	149	CSA120DC	47	F06DKBG5B	74	R162EAD	118
CDM16CC	149	CSA240FC	48	F06DPCG5C	75	R162S24	137
CDM16CS	148	CSBC	51	F07TDVST2	68	R162T24	138
CDM24AC	149	CSBD	58	F100TDVST2	68	R41E11A	120
CDM24CC	149	CSBP30Y	56	F100TYT2	72	R41E22A	121
CDM24CS	148	CSC120B	57	F10TYG9	73	R41E24	112
CEP-BCB	65	CSC120C	57	F12DKBG5B	74	R41E24P	113
CEP-BCR	65	CSD15B	17	F12DPCG5C	75	R41EAD	114
CEP-D1	65	CSD15C	17	F150TDS84C	69	R41S24F	139
CEP-D2	65	CSD30C	18	F16DKCG5B	74	R41U24F	115
CEP-D3	65	CSD30E	18	F16DPCG5C	75	R42E24	116
CEP-MTW	65	CSD30F	18	F16TDVST2	68	R42E24P	117
CEP-RCC	65	CSD50B	19	F16TYT2	72	R42EAD	118
CEP-RCP	65	CSD70C	20	F180TDS84C	69	R42S24	137
CEP-SS	65	CSF120B	24	F200TDS84C	70	R42T24	138
CH-B12,5	152	CSF120C	24	F20DKCG5B	74	R81E11A	120
CH-C	152	CSF120CP	24	F20DPCG5C	75	R81E22A	121
CH-C10	152	CSF120DP	24	F20TYS9	73	R81E24	112
CH-C22,5	152	CSF240B	25	F25TYT2	72	R81E24P	113
CH-C32,5	152	CSF240C	25	F300TDS84C	71	R81EAD	114
CH-CA	152	CSF240CP	25	F30DKC55B	74	R81S24F	139
CH-CF	152	CSF240DP	25	F30DPCG5C	75	R81U24F	115
CH-S	152	CSF240G	26	F30TDVST2	68	R82E24	116
CI-NPN/PNP	99	CSF30B	22	F36TYT2	72	R82E24P	117
CK/PT	153	CSF30C	22	F400TDS84C	71	R82EAD	118
CK/S	153	CSF500C	27	F42TDVST2	68	R82S24	137
CKB	153	CSF500D	27	F50TYT2	72	R82T24	138
CKBG	153	CSF500G	28	F55TDVST2	68	RE1024D	101
CKBX2	153	CSF5-65	29	F75TDVST2	68	RE1824D	101
CK-PCB	153	CSF85B	23	IF10PML	145	RE2024D	102
CKR16	109	CSF85C	23	IF10PMS	145	RF1012D	102
CKR25	109	CSF85CP	23	IF14PML	145	RF1024D	101
CKS15E	134	CSG2401C	44	IF14PMS	145	RF1824D	101
CKS15NA	133	CSG2401D	44	IF16PML	145	RFA024D	101
CKS15NB	133	CSG2401G	45	IF16PMS	145	RFE16124	128
CKS1S	136	CSG2401R	45	IF16S7	125	RFE16224	128
CKS22	134	CSG481C	40	IF20PML	145	RFE8124	126
CL1R	49	CSG500C	41	IF20PMS	145	RFE8224	127
CL5R	49	CSG500D	41	IF26PML	145	RMP081CM	120
CLP08CC	151	CSG500G	41	IF26PMS	145	SW01VA	95
CLP16CC	151	CSG720C	42	IF34PML	145	SW05VA	95
CLT08AC	150	CSG720D	42	IF34PMS	145	SW10VA	95
CLT08CC	150	CSG960C	43	IF40PML	145	SW20VA	96
CLT16AC	150	CSG960D	43	IF40PMS	145	SW50VA	96
CLT16CC	150	CSG960G	43	IF416LS7	125	WAA7-0540	94
CM1A012	106	CSL120C	32	IF416S7	125	WAA7-0541	94
CM1A024	106	CSL481C	34	ISD09FM	142	WAA7-0542	94
CM1A120	106	CSR50U	59	ISD09PF	142		
CM1A230	106	CSU070S	53	ISD09PM	142		
CM1C012	103	CSU240S	54	ISD15FM	142		
CM1C024	103	CSU500S	55	ISD15PF	142		
CM1C048	103	CS-UPS1	52	ISD15PM	142		
CM1C110	103	CS-UPS2	52	ISD25FM	142		
CM1S024	131	CSW121B	36	ISD25PF	142		
CM1S024E	131	CSW121C	36	ISD25PFL	143		
CM1T024	132	CSW121DP	36	ISD25PML	142		
CM1T024E	132	CSW241B	37	ISD25PML	143		
CM2A012	106	CSW241C	37	ISD37FM	142		
CM2A024	107	CSW241DP	37	ISD37PF	142		
CM2A120	107	CSW241G	37	ISD37PFL	143		
CM2A230	107	CSW481C	38	ISD37PML	142		
CM2C012	104	CSW481D	38	ISD37PML	143		
CM2C024	104	CSW481G	38	LCONALSFDI	88		
CM2C048	104	CWAA7-0530	84	LCONTADFDT	89		
CM2C110	104	CWAA7-0531	84	LCONTLSFDI	90		
CM4C012	105	CWAA7-0532	84	LCONZBUSB	88		
CM4C024	105	CWAA7-0533	85	MBC2K	60		
CMB16B	155	CWAA7-0534	85	NUPUTUK50	155		
CMB27B	155	CWAA7-0535	85	O332060	130		
CNU/8/51	155	CWAA7-0536	86	O332240	130		

# Index by Catalogue number

CODE	PAGE	CODE	PAGE	CODE	PAGE	CODE	PAGE
8901028	153	XCDM24CC	149	XCSF120C	24	XIF416S7	125
8911012	56	XCDM24CS	148	XCSF120CP	24	XISD09FM	142
ISPD1425G	62	XCEPBCB	65	XCSF120DP	24	XISD09PF	142
ISPD14275	62	XCEPBCR	65	XCSF240B	25	XISD09PM	142
ISPD14440	62	XCEPD1	65	XCSF240C	25	XISD15FM	142
ISPD1444G	62	XCEPD2	65	XCSF240CP	25	XISD15PF	142
NU0851	155	XCEPD3	65	XCSF240DP	25	XISD15PM	142
NUPUTUK50	155	XCEPMTW	65	XCSF240G	26	XISD25FM	142
PR001	158	XCEPRCC	65	XCSF30B	22	XISD25PF	142
PR002	158	XCEPRCP	65	XCSF30C	22	XISD25PFL	143
PR003	157	XCEPSS	65	XCSF500C	27	XISD25PM	142
PR004	158	XCKB	153	XCSF500D	27	XISD25PML	143
PR005	157	XCKBG	153	XCSF500G	28	XISD37FM	142
PR006	157	XCKPT	153	XCSF565	29	XISD37PF	142
PR007	157	XCKR16	109	XCSF85B	23	XISD37PFL	143
PR009	158	XCKR25	109	XCSF85C	23	XISD37PM	142
PR010	158	XCKS	153	XCSF85CP	23	XISD37PML	143
PR901	158	XCKS15E	134	XCSG2401C	44	XMBC2K	60
PR903	157	XCKS15NA	133	XCSG2401D	44	XNPNPNP	99
PR904	158	XCKS15NB	133	XCSG2401G	45	XO332060	130
PR905	157	XCKS1S	136	XCSG2401R	45	XO332240	130
PR906	157	XCKS22	134	XCSG481C	40	XR041E1A	120
PR907	157	XCKX2	153	XCSG500C	41	XR041E2A	112
PR909	158	XCL1R	49	XCSG500D	41	XR041E24P	113
PR910	158	XCL5R	49	XCSG500G	41	XR041E2A	121
PTCCK42	154	XCLP08CC	151	XCSG720C	42	XR041EAD	114
X756340	89	XCLP16CC	151	XCSG720D	42	XR041S24F	139
X756360	88	XCLT08AC	150	XCSG960C	43	XR041U24F	115
X756370	90	XCLT08CC	150	XCSG960D	43	XR042E2A	116
X756510	83	XCLT16AC	150	XCSG960G	43	XR042E24P	117
X756516	82	XCLT16CC	150	XCSL120C	32	XR042EAD	118
X756517	82	XCM1A012	106	XCSL240C	33	XR042S24	137
X756524	97	XCM1A024	106	XCSL481C	34	XR042T24	138
X756526	87	XCM1A120	106	XCSL85C	31	XR081E1A	120
X756527	87	XCM1A230	106	XCSR50U	59	XR081E2A	112
X756530	84	XCM1C012	103	XCSU070S	53	XR081E24P	113
X756531	84	XCM1C024	103	XCSU240S	54	XR081E2A	121
X756532	84	XCM1C048	103	XCSU500S	55	XR081EAD	114
X756533	85	XCM1C110	103	XCSUPS1	52	XR081S24F	139
X756534	85	XCM1S024	131	XCSUPS2	52	XR081U24F	115
X756535	85	XCM1S024E	131	XCSW121B	36	XR082E2A	116
X756536	86	XCM1T024	132	XCSW121C	36	XR082E24P	117
X756537	86	XCM1T024E	132	XCSW121DP	36	XR082EAD	118
X756538	86	XCM2A012	106	XCSW241B	37	XR082S24	137
X756539	83	XCM2A024	107	XCSW241C	37	XR082T24	138
X756540	94	XCM2A120	107	XCSW241DP	37	XR161E1A	120
X756541	94	XCM2A230	107	XCSW241G	37	XR161E2A	112
X756542	94	XCM2C012	104	XCSW481C	38	XR161E24P	113
X756816	91	XCM2C024	104	XCSW481D	38	XR161E2A	121
X756817	91	XCM2C048	104	XCSW481G	38	XR161EAD	114
X756844	92	XCM2C110	104	XF03DKBG5B	74	XR161S24F	139
X756847	92	XCM4C012	105	XF03DPCG5C	75	XR161U24F	115
X756894	88	XCM4C024	105	XF06DKBG5B	74	XR162E2A	116
X766082	136	XCMB16B	155	XF06DPCG5C	75	XR162E24P	117
X766083	135	XCMB27B	155	XF07TDVST2	68	XR162EAD	118
X766184	98	XCOP082	140	XF100TDVST2	68	XR162S24	137
X766802	154	XCPC20M	146	XF100TYT2	72	XR162T24	138
X766803	154	XCPC26M	146	XF10TYG9	73	XRE1024D	101
X766804	154	XCPC34M	146	XF12DKBG5B	74	XRE1824D	101
X766813	154	XCPC40M	146	XF12DPCG5C	75	XRE2024D	102
X766842	110	XCPC50M	146	XF150TDS84C	69	XRF1012D	102
X766845	110	XCPC60M	146	XF16DKCG5B	74	XRF1024D	101
X766846	110	XCPC64M	146	XF16DPCG5C	75	XRF1824D	101
X766847	110	XCPD25F	144	XF16TDVST2	68	XRFA024D	101
X766848	110	XCPD25M	144	XF16TYT2	72	XRFE16124	128
XAR1	50	XCPD37F	144	XF180TDS84C	69	XRFE16224	128
XAR6	50	XCPD37M	144	XF200TDS84C	70	XRFE8124	126
XBB125	152	XCPD50F	144	XF20DKCG5B	74	XRFE8224	127
XBC000	152	XCPD50M	144	XF20DPCG5C	75	XRMP081CM	120
XBC010	152	XCR41	122	XF20TYS9	73	XW000928	95
XBC225	152	XCR42SC	123	XF25TYT2	72	XW000929	95
XBC325	152	XCR81	122	XF300TDS84C	71	XW000930	95
XBCA00	152	XCR83	126	XF30DKCS5B	74	XW000931	96
XBCF00	152	XCRE41	122	XF30DPCG5C	75	XW000932	96
XBS000	152	XCRE42SC	123	XF30TDVST2	68	Z121017	157
XCAPI03	81	XCRE81	122	XF36TYT2	72	Z121019	157
XCCIS2	93	XCRE83	126	XF400TDS84C	71		
XCCM04SF	147	XCSA120BC	46	XF42TDVST2	68		
XCCM08CV	147	XCSA120BD	46	XF50TYT2	72		
XCCM08SF	147	XCSA120CB	46	XF55TDVST2	68		
XCCM08SV	147	XCSA120CC	46	XF75TDVST2	68		
XCCM12SF	147	XCSA120DB	47	XIF10PML	145		
XCCM16CV	147	XCSA120DC	47	XIF10PMS	145		
XCCM16SV	147	XCSA240FC	48	XIF14PML	145		
XCCM24SV	147	XCSBC	51	XIF14PMS	145		
XCDIN2	156	XCSBD	58	XIF16PML	145		
XCDIN4	156	XCSBP30Y	56	XIF16PMS	145		
XCDIN5	156	XCSC120B	57	XIF16S7	125		
XCDINM45	156	XCSC120C	57	XIF20PML	145		
XCDIWMF2	155	XCSD15B	17	XIF20PMS	145		
XCDM08AC	149	XCSD15C	17	XIF26PML	145		
XCDM08CC	149	XCSD30C	18	XIF26PMS	145		
XCDM08CS	148	XCSD30E	18	XIF34PML	145		
XCDM16AC	149	XCSD30F	18	XIF34PMS	145		
XCDM16CC	149	XCSD50B	19	XIF40PML	145		
XCDM16CS	148	XCSD70C	20	XIF40PMS	145		
XCDM24AC	149	XCSF120B	24	XIF416LS7	125		